

|         |               |           |
|---------|---------------|-----------|
| UNIT    | COOLING TOWER |           |
| MODEL # | AT 310-4M36   | SCALE NTS |



|          |                 |      |           |
|----------|-----------------|------|-----------|
| DWG. #   | T3TM3C48-DRD-ST | REV. | -         |
| SERIAL # |                 | DATE | 10/9/2024 |

- NOTES:
- (M)- FAN MOTOR LOCATION
  - HEAVIEST SECTION IS UPPER SECTION
  - MPT DENOTES MALE PIPE THREAD  
FPT DENOTES FEMALE PIPE THREAD  
BFW DENOTES BEVELED FOR WELDING  
GVD DENOTES GROOVED  
FLG DENOTES FLANGE
  - +UNIT WEIGHT DOES NOT INCLUDE ACCESSORIES (SEE ACCESSORY DRAWINGS)
  - MAKE-UP WATER PRESSURE  
20 psi MIN [137 kPa], 50 psi MAX [344 kPa]
  - 3/4" [19MM] DIA. MOUNTING HOLES. REFER TO RECOMENDED STEEL SUPPORT DRAWING.
  - DIMENSIONS LISTED AS FOLLOWS:  
ENGLISH FT-IN  
[METRIC] [mm]

**FACE B  
PLAN VIEW**

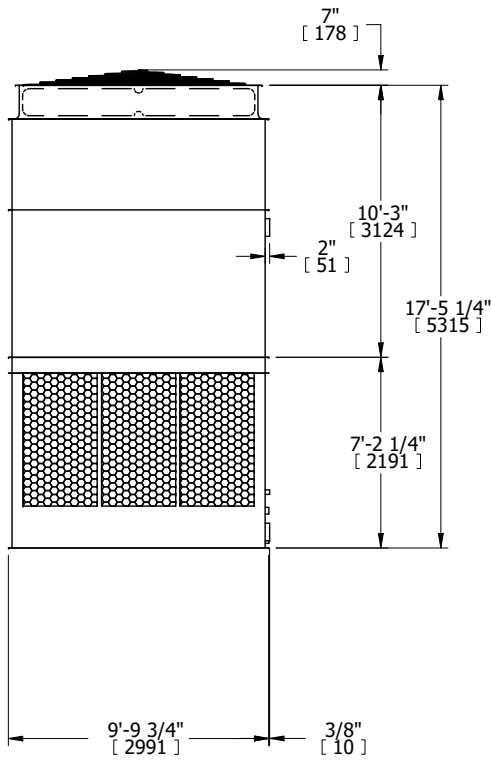
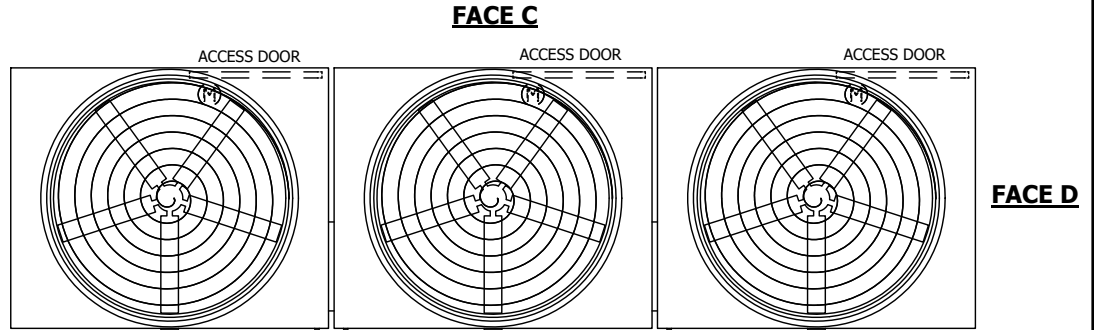

**FACE B**

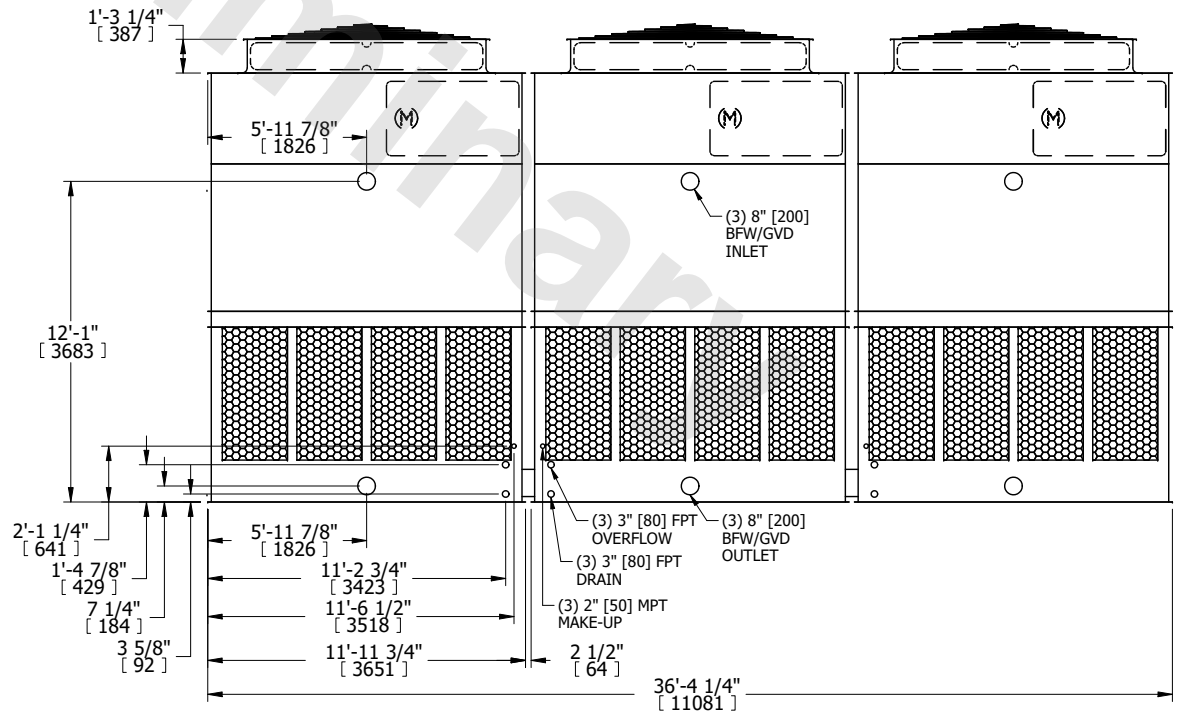

**FACE A**

|                 |                        |                  |                        |                         |                      |                          |   |           |     |
|-----------------|------------------------|------------------|------------------------|-------------------------|----------------------|--------------------------|---|-----------|-----|
| SHIPPING WEIGHT | 24240 lbs+ [11000] kg+ | OPERATING WEIGHT | 39290 lbs+ [17825] kg+ | HEAVIEST SECTION WEIGHT | 5370 lbs+ [2440] kg+ | NO. OF SHIPPING SECTIONS | 6 | DRAWN BY: | JLG |
|-----------------|------------------------|------------------|------------------------|-------------------------|----------------------|--------------------------|---|-----------|-----|