

UNIT	COOLING TOWER	
MODEL #	AT 14-2F6	SCALE NTS

EVAPCO, INC.

DWG. #	T3040624-DRJ-ST	REV.	-
SERIAL #		DATE	3/10/2025

NOTES:

- (M)- FAN MOTOR LOCATION
- HEAVIEST SECTION IS UPPER SECTION
- MPT DENOTES MALE PIPE THREAD
FPT DENOTES FEMALE PIPE THREAD
BFW DENOTES BEVELED FOR WELDING
GVD DENOTES GROOVED
FLG DENOTES FLANGE
- +UNIT WEIGHT DOES NOT INCLUDE ACCESSORIES (SEE ACCESSORY DRAWINGS)
- MAKE-UP WATER PRESSURE
20 psi MIN [137 kPa], 50 psi MAX [344 kPa]
- 3/4" [19MM] DIA. MOUNTING HOLES. REFER TO RECOMENDED STEEL SUPPORT DRAWING.
- DIMENSIONS LISTED AS FOLLOWS:
ENGLISH FT-IN
[METRIC] [mm]

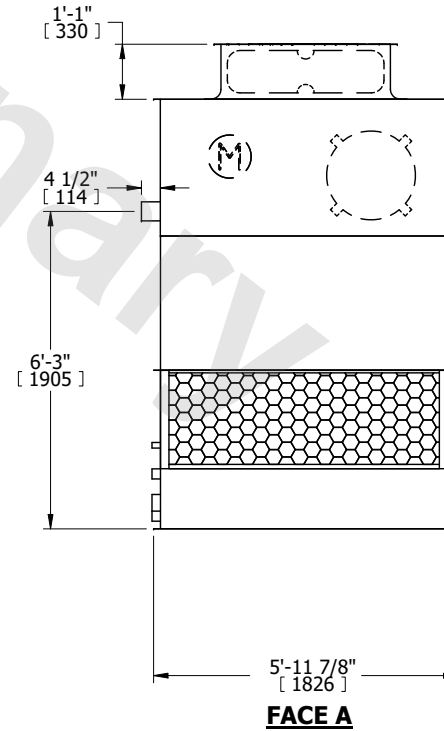
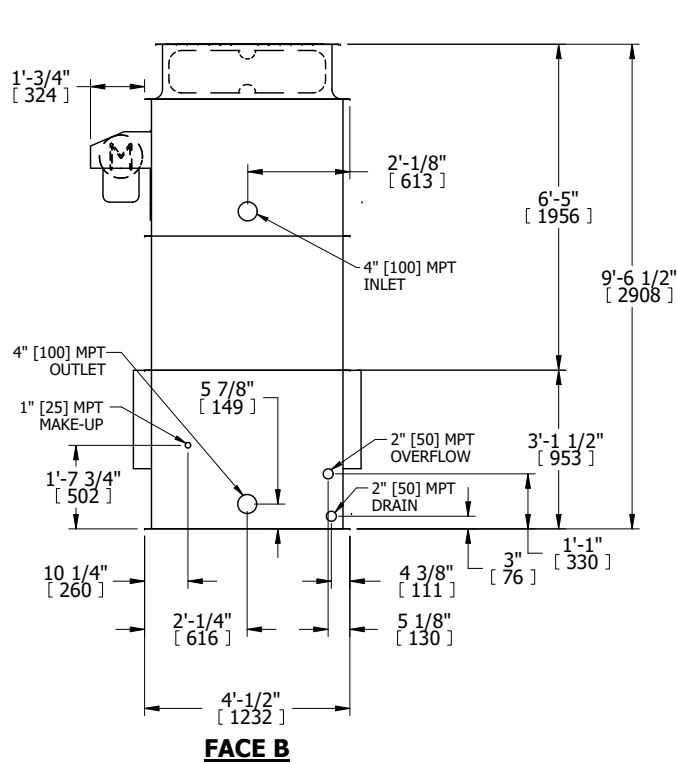
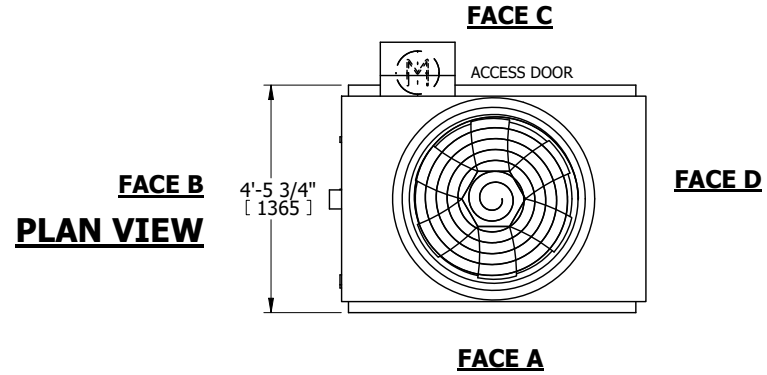

SHIPPING WEIGHT	1390 lbs+ [635] kg+	OPERATING WEIGHT	2410 lbs+ [1095] kg+	HEAVIEST SECTION WEIGHT	950 lbs+ [435] kg+	NO. OF SHIPPING SECTIONS	2	DRAWN BY:	KWC
-----------------	---------------------	------------------	----------------------	-------------------------	--------------------	--------------------------	---	-----------	-----