

| | | |
|---------|---------------|-----------|
| UNIT | COOLING TOWER | |
| MODEL # | AT 14-3G6 | SCALE NTS |



| | | | |
|----------|-----------------|------|-----------|
| DWG. # | T3040636-DRJ-ST | REV. | - |
| SERIAL # | | DATE | 3/13/2025 |

- NOTES:
- (M)- FAN MOTOR LOCATION
 - HEAVIEST SECTION IS UPPER SECTION
 - MPT DENOTES MALE PIPE THREAD
FPT DENOTES FEMALE PIPE THREAD
BFW DENOTES BEVELED FOR WELDING
GVD DENOTES GROOVED
FLG DENOTES FLANGE
 - +UNIT WEIGHT DOES NOT INCLUDE ACCESSORIES (SEE ACCESSORY DRAWINGS)
 - MAKE-UP WATER PRESSURE
20 psi MIN [137 kPa], 50 psi MAX [344 kPa]
 - 3/4" [19MM] DIA. MOUNTING HOLES. REFER TO RECOMENDED STEEL SUPPORT DRAWING.
 - DIMENSIONS LISTED AS FOLLOWS:
ENGLISH FT-IN
[METRIC] [mm]

**FACE B
PLAN VIEW**

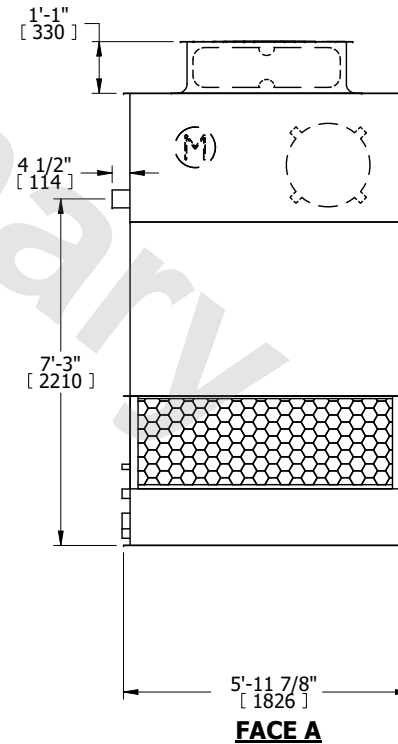
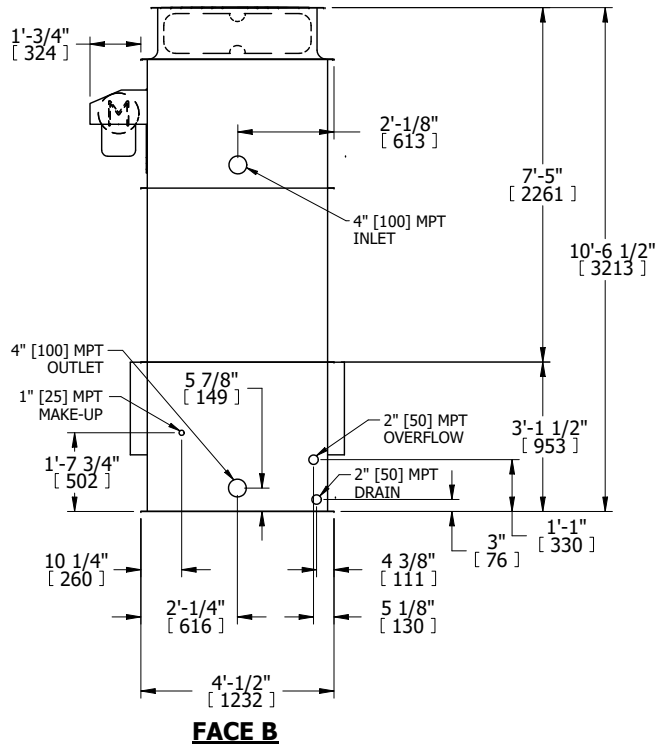
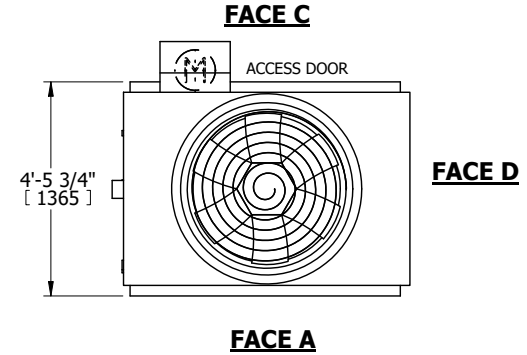

| | | | | | | | | | |
|-----------------|---------------------|------------------|----------------------|-------------------------|---------------------|--------------------------|---|-----------|-----|
| SHIPPING WEIGHT | 1510 lbs+ [685] kg+ | OPERATING WEIGHT | 2530 lbs+ [1150] kg+ | HEAVIEST SECTION WEIGHT | 1070 lbs+ [490] kg+ | NO. OF SHIPPING SECTIONS | 2 | DRAWN BY: | KWC |
|-----------------|---------------------|------------------|----------------------|-------------------------|---------------------|--------------------------|---|-----------|-----|