

UNIT	COOLING TOWER	
MODEL #	AT 212-319	SCALE NTS

EVAPCO, INC.

DWG. #	T3128536-DRF-ST	REV.	-
SERIAL #		DATE	10/4/2024

- NOTES:
- (M)- FAN MOTOR LOCATION
 - HEAVIEST SECTION IS UPPER SECTION
 - MPT DENOTES MALE PIPE THREAD
FPT DENOTES FEMALE PIPE THREAD
BFW DENOTES BEVELED FOR WELDING
GVD DENOTES GROOVED
FLG DENOTES FLANGE
 - +UNIT WEIGHT DOES NOT INCLUDE ACCESSORIES (SEE ACCESSORY DRAWINGS)
 - MAKE-UP WATER PRESSURE
20 psi MIN [137 kPa], 50 psi MAX [344 kPa]
 - 3/4" [19MM] DIA. MOUNTING HOLES.
REFER TO RECOMMENDED STEEL SUPPORT DRAWING
 - DIMENSIONS LISTED AS FOLLOWS:
ENGLISH FT-IN
[METRIC] [mm]

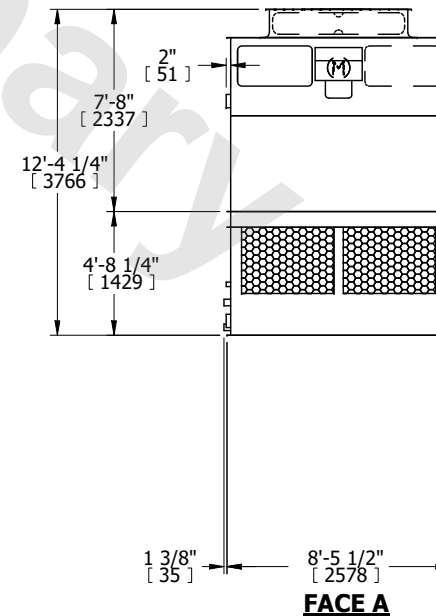
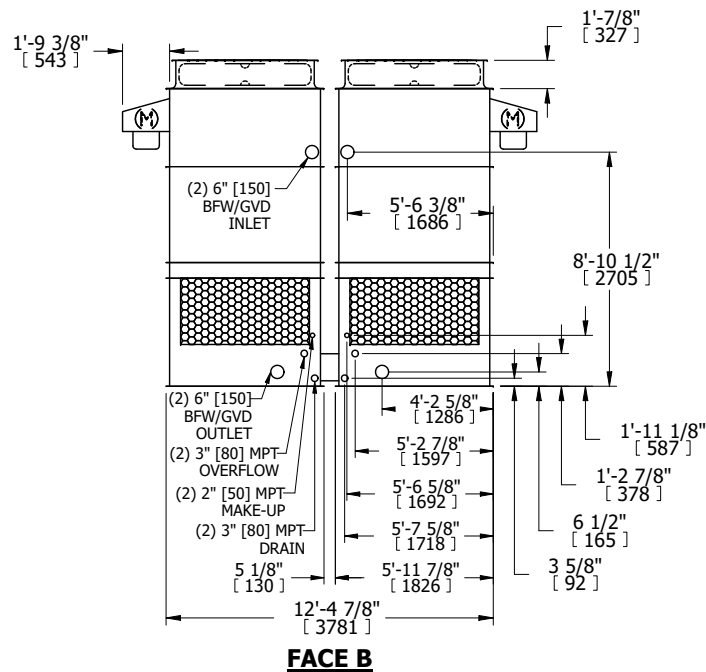

SHIPPING WEIGHT	6940 lbs+ [3150] kg+	OPERATING WEIGHT	11020 lbs+ [5000] kg+	HEAVIEST SECTION WEIGHT	2280 lbs+ [1035] kg+	NO. OF SHIPPING SECTIONS	4	DRAWN BY:	KDS
-----------------	----------------------	------------------	-----------------------	-------------------------	----------------------	--------------------------	---	-----------	-----