

| | | |
|---------|---------------|-----------|
| UNIT | COOLING TOWER | |
| MODEL # | AT 217-3K14 | SCALE NTS |

EVAPCO, INC.

| | | | |
|----------|-----------------|------|-----------|
| DWG. # | T3171436-DRG-ST | REV. | - |
| SERIAL # | | DATE | 9/20/2024 |

- NOTES:
- (M)- FAN MOTOR LOCATION
 - HEAVIEST SECTION IS UPPER SECTION
 - MPT DENOTES MALE PIPE THREAD
FPT DENOTES FEMALE PIPE THREAD
BFW DENOTES BEVELED FOR WELDING
GVD DENOTES GROOVED
FLG DENOTES FLANGE
 - +UNIT WEIGHT DOES NOT INCLUDE ACCESSORIES (SEE ACCESSORY DRAWINGS)
 - MAKE-UP WATER PRESSURE
20 psi MIN [137 kPa], 50 psi MAX [344 kPa]
 - 3/4" [19MM] DIA. MOUNTING HOLES.
REFER TO RECOMMENDED STEEL SUPPORT DRAWING
 - DIMENSIONS LISTED AS FOLLOWS:
ENGLISH FT-IN
[METRIC] [mm]

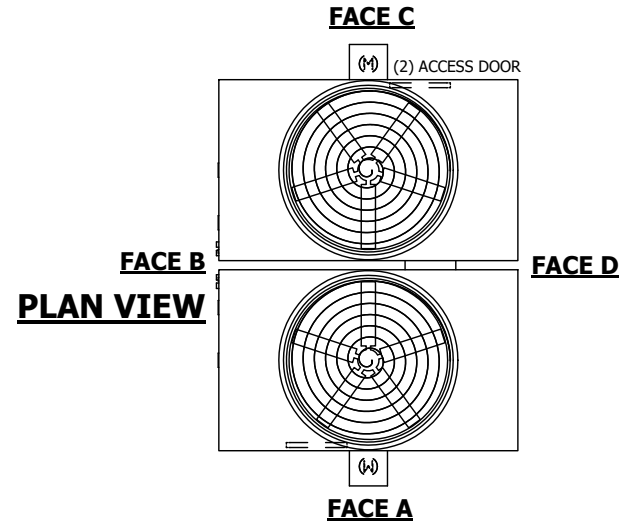

| | | | | | | | | | |
|-----------------|-----------------------|------------------|-----------------------|-------------------------|----------------------|--------------------------|---|-----------|-----|
| SHIPPING WEIGHT | 12760 lbs+ [5790] kg+ | OPERATING WEIGHT | 21780 lbs+ [9880] kg+ | HEAVIEST SECTION WEIGHT | 4240 lbs+ [1925] kg+ | NO. OF SHIPPING SECTIONS | 4 | DRAWN BY: | KDS |
|-----------------|-----------------------|------------------|-----------------------|-------------------------|----------------------|--------------------------|---|-----------|-----|