

UNIT	COOLING TOWER	
MODEL #	AT 342-5N26	SCALE NTS

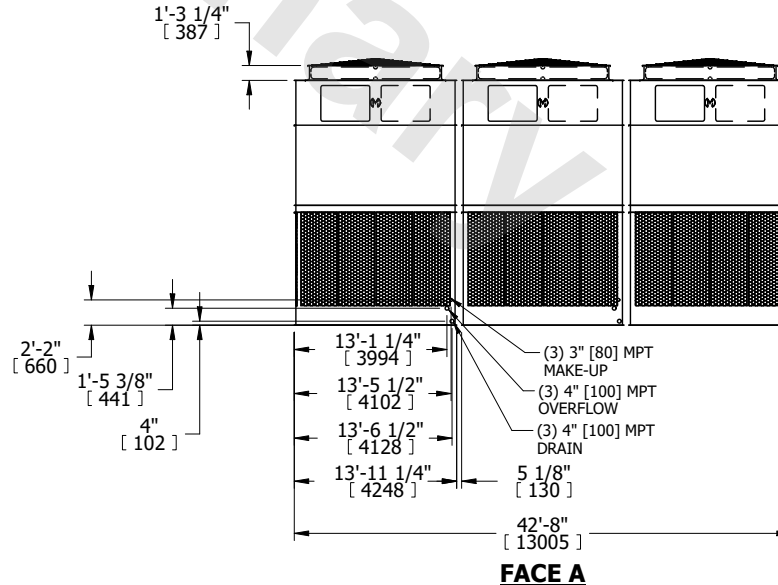

DWG. #	T3BI422660-DRD-ST	REV.	-
SERIAL #		DATE	10/4/2024

- NOTES:
- (M)- FAN MOTOR LOCATION
 - HEAVIEST SECTION IS UPPER SECTION
 - MPT DENOTES MALE PIPE THREAD
FPT DENOTES FEMALE PIPE THREAD
BFW DENOTES BEVELED FOR WELDING
GVD DENOTES GROOVED
FLG DENOTES FLANGE
 - +UNIT WEIGHT DOES NOT INCLUDE ACCESSORIES (SEE ACCESSORY DRAWINGS)
 - MAKE-UP WATER PRESSURE
20 psi MIN [137 kPa], 50 psi MAX [344 kPa]
 - PAN EQUALIZER PIPING IS SUPPLIED BY OTHERS, FLUME SUPPLIED BY EVAPCO.
 - FOR BOTTOM CONNECTION SPECIFICATIONS, SEE DETAIL.
 - 3/4" [19mm] DIA. MOUNTING HOLES. REFER TO RECOMMENDED STEEL SUPPORT DRAWING
 - DIMENSIONS LISTED AS FOLLOWS:
ENGLISH FT-IN
[METRIC] [mm]

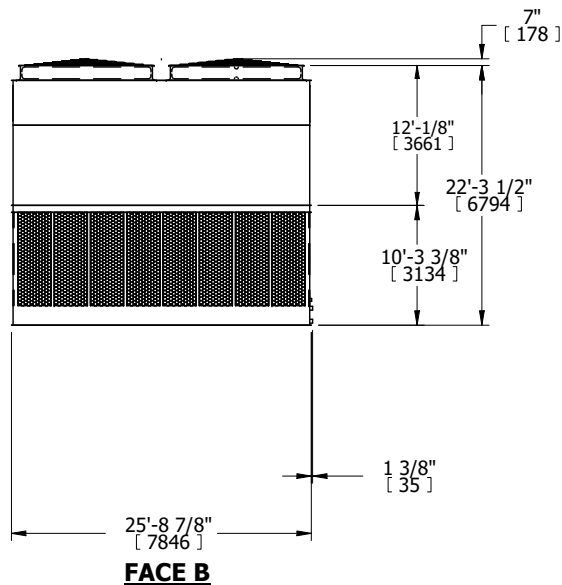

SHIPPING WEIGHT	74850 lbs+ [33955] kg+	OPERATING WEIGHT	125850 lbs+ [57085] kg+	HEAVIEST SECTION WEIGHT	18140 lbs+ [8230] kg+	NO. OF SHIPPING SECTIONS	6	DRAWN BY:	SLR
-----------------	------------------------	------------------	-------------------------	-------------------------	-----------------------	--------------------------	---	-----------	-----