

| | | |
|---------|-----------------------|-----------|
| UNIT | CLOSED CIRCUIT COOLER | |
| MODEL # | eco-LSWE 8P-3M12 | SCALE NTS |



| | | | |
|----------|------------------|------|-----------|
| DWG. # | WLEP81206-DRD-ST | REV. | - |
| SERIAL # | | DATE | 11/7/2024 |

- NOTES:
- (M)- FAN MOTOR LOCATION
 - HEAVIEST SECTION IS COIL SECTION
 - MPT DENOTES MALE PIPE THREAD
FPT DENOTES FEMALE PIPE THREAD
BFW DENOTES BEVELED FOR WELDING
GVD DENOTES GROOVED
FLG DENOTES FLANGE
PE DENOTES PLAIN END
 - +UNIT WEIGHT DOES NOT INCLUDE ACCESSORIES (SEE ACCESSORY DRAWINGS)
 - 3/4" [19mm] DIA. MOUNTING HOLES. REFER TO RECOMMENDED STEEL SUPPORT DRAWING
 - DIMENSIONS LISTED AS FOLLOWS: ENGLISH FT IN [METRIC] [mm]
 - * - APPROXIMATE DIMENSIONS DO NOT USE FOR PRE-FABRICATION OF CONNECTING PIPING
 - MAKE-UP WATER PRESSURE
20 psi [137 kPa] MIN, 50 psi [344 kPa] MAX

FACE B
PLAN VIEW

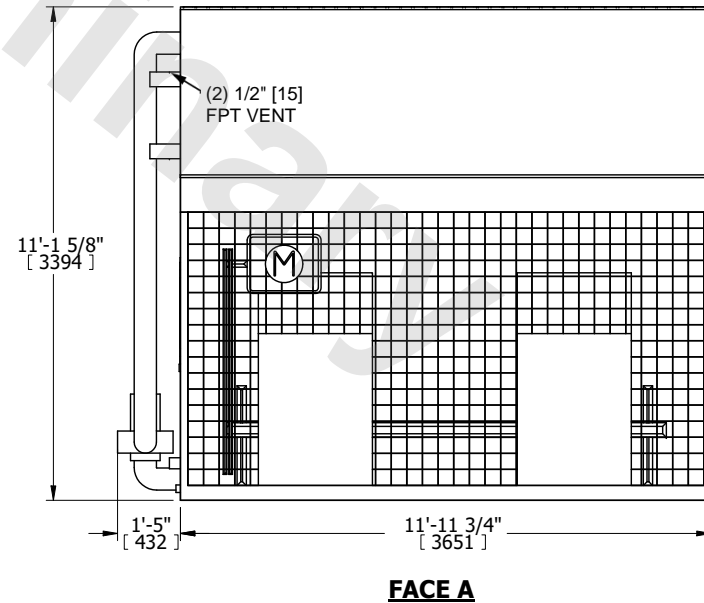
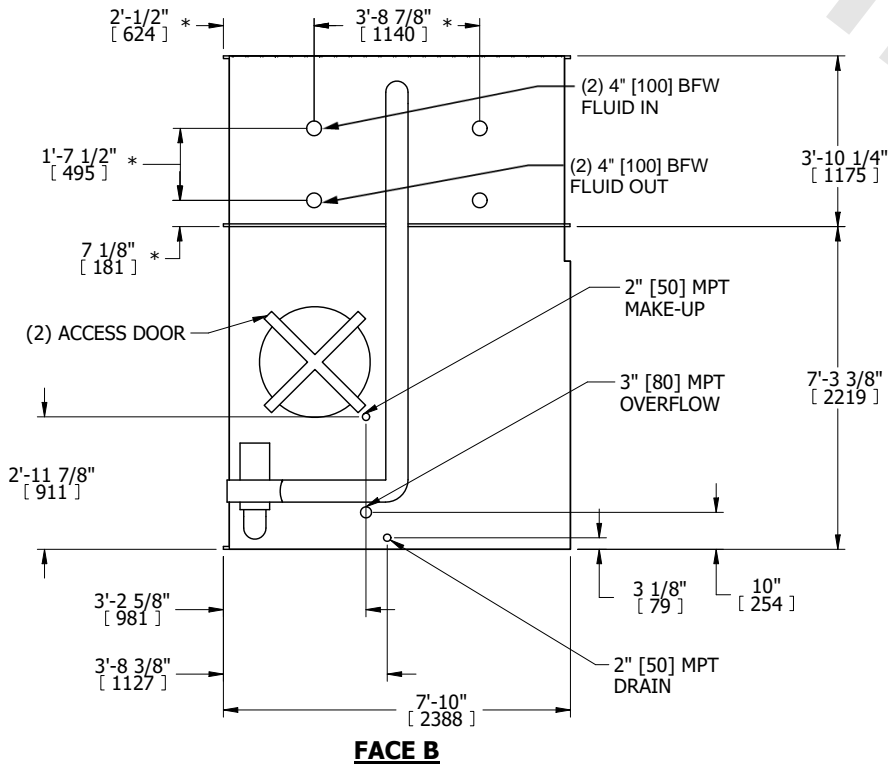
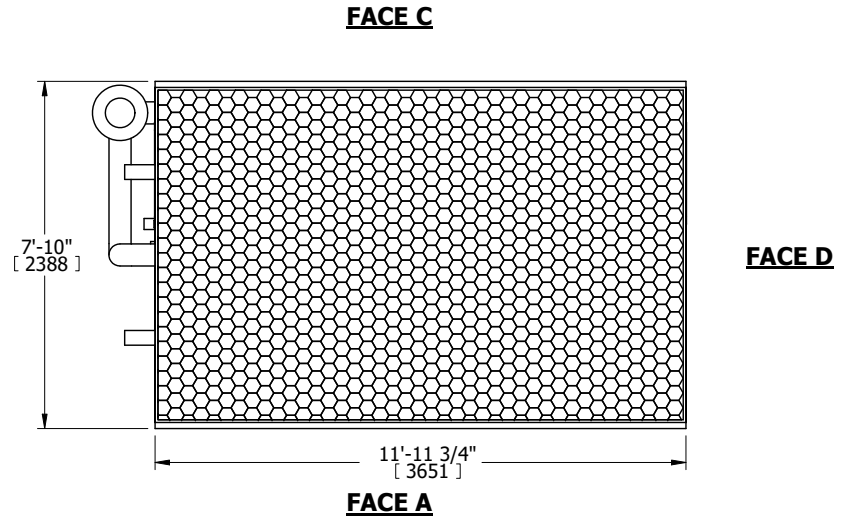

| | | | | | | | | | |
|-----------------|-----------------------|------------------|-----------------------|-------------------------|----------------------|--------------------------|---|-----------|-----|
| SHIPPING WEIGHT | 11480 lbs+ [5210] kg+ | OPERATING WEIGHT | 16520 lbs+ [7495] kg+ | HEAVIEST SECTION WEIGHT | 7610 lbs+ [3455] kg+ | NO. OF SHIPPING SECTIONS | 2 | DRAWN BY: | TLS |
|-----------------|-----------------------|------------------|-----------------------|-------------------------|----------------------|--------------------------|---|-----------|-----|