

UNIT	CLOSED CIRCUIT COOLER	
MODEL #	eco-LSWE 4-516-Z	SCALE NTS

EVAPCO, INC.

DWG. #	WLE040610-DRD-SF	REV.	-
SERIAL #		DATE	11/5/2024

- NOTES:
- (M)- FAN MOTOR LOCATION
 - MPT DENOTES MALE PIPE THREAD
FPT DENOTES FEMALE PIPE THREAD
BFW DENOTES BEVELED FOR WELDING
GVD DENOTES GROOVED
FLG DENOTES FLANGE
PE DENOTES PLAIN END
 - +UNIT WEIGHT DOES NOT INCLUDE ACCESSORIES (SEE ACCESSORY DRAWINGS)
 - 3/4" [19mm] DIA. MOUNTING HOLES. REFER TO RECOMMENDED STEEL SUPPORT DRAWING
 - DIMENSIONS LISTED AS FOLLOWS: ENGLISH FT IN [METRIC] [mm]
 - * - APPROXIMATE DIMENSIONS DO NOT USE FOR PRE-FABRICATION OF CONNECTING PIPING
 - HEAVIEST SECTION IS COIL SECTION
 - MAKE-UP WATER PRESSURE
20 psi [137 kPa] MIN, 50 psi [344 kPa] MAX
 - MAKE-UP CONNECTION LOCATED 7-5/8" [194] FROM CONNECTION END OF UNIT
 - SERIES FLOW PIPING AND AUX. CROSSOVER DRAIN ARE BY OTHERS

**FACE B
PLAN VIEW**

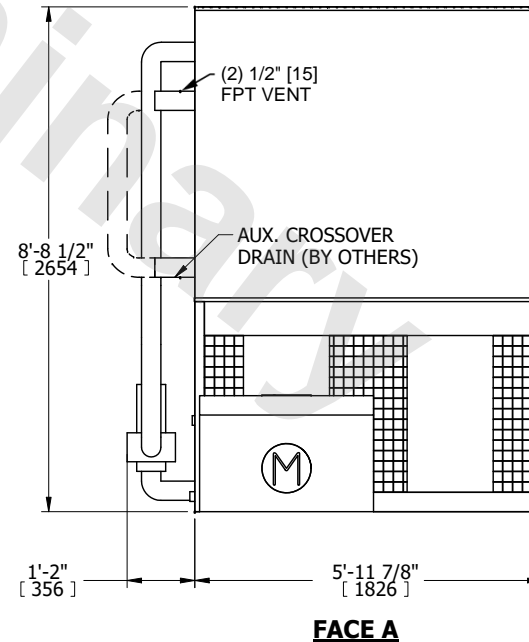
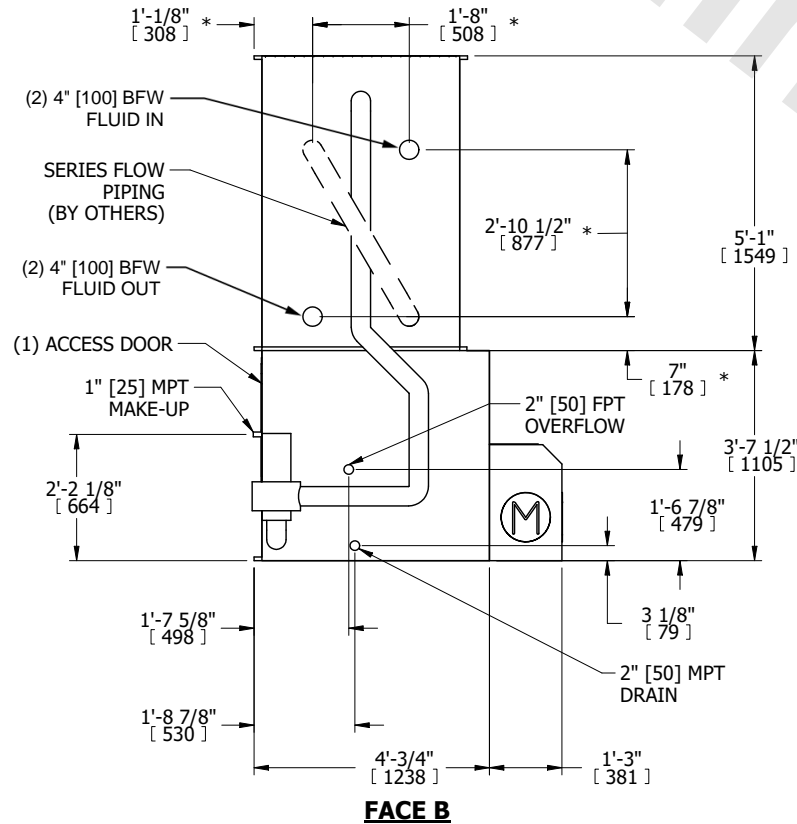
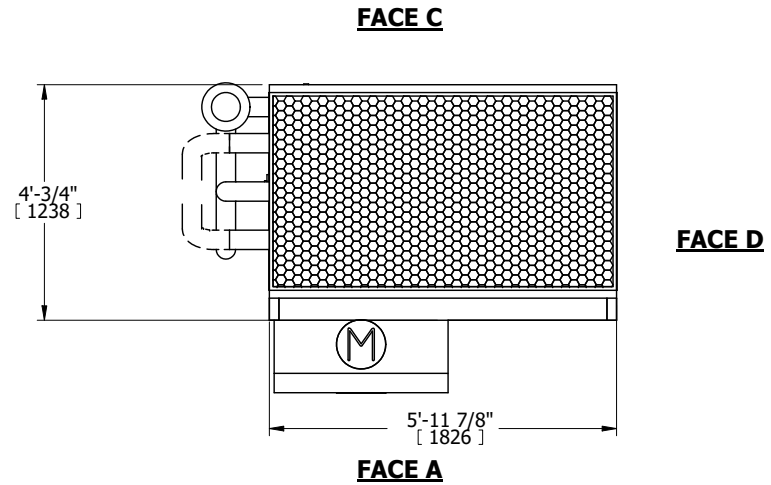

SHIPPING WEIGHT	4150 lbs+ [1885] kg+	OPERATING WEIGHT	5420 lbs+ [2460] kg+	HEAVIEST SECTION WEIGHT	2940 lbs+ [1335] kg+	NO. OF SHIPPING SECTIONS	2	DRAWN BY:	TLS
-----------------	----------------------	------------------	----------------------	-------------------------	----------------------	--------------------------	---	-----------	-----