

UNIT	<b>CLOSED CIRCUIT COOLER</b>	
MODEL #	eco-LSWE 5-4K18-Z	SCALE NTS

# EVAPCO, INC.

DWG. #	WLE051808-DRD-SF	REV.	-
SERIAL #		DATE	11/6/2024

- NOTES:
- (M)- FAN MOTOR LOCATION
  - MPT DENOTES MALE PIPE THREAD  
FPT DENOTES FEMALE PIPE THREAD  
BFW DENOTES BEVELED FOR WELDING  
GVD DENOTES GROOVED  
FLG DENOTES FLANGE  
PE DENOTES PLAIN END
  - +UNIT WEIGHT DOES NOT INCLUDE ACCESSORIES (SEE ACCESSORY DRAWINGS)
  - 3/4" [19mm] DIA. MOUNTING HOLES. REFER TO RECOMMENDED STEEL SUPPORT DRAWING
  - DIMENSIONS LISTED AS FOLLOWS: ENGLISH FT IN [METRIC] [mm]
  - \* - APPROXIMATE DIMENSIONS DO NOT USE FOR PRE-FABRICATION OF CONNECTING PIPING
  - HEAVIEST SECTION IS COIL SECTION
  - MAKE-UP WATER PRESSURE  
20 psi [137 kPa] MIN, 50 psi [344 kPa] MAX
  - SERIES FLOW PIPING AND AUX. CROSSOVER DRAIN ARE BY OTHERS

**FACE B**  
**PLAN VIEW**

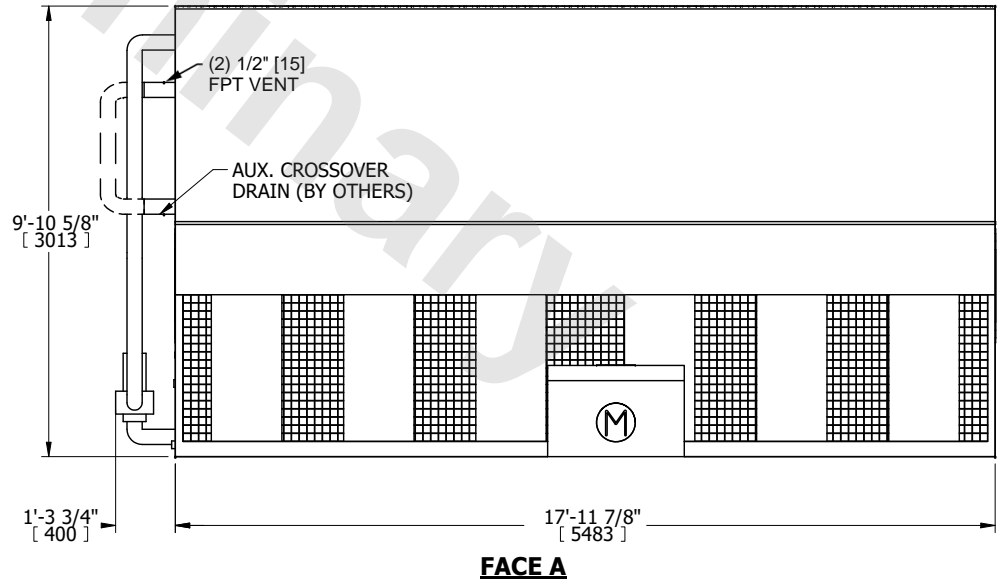
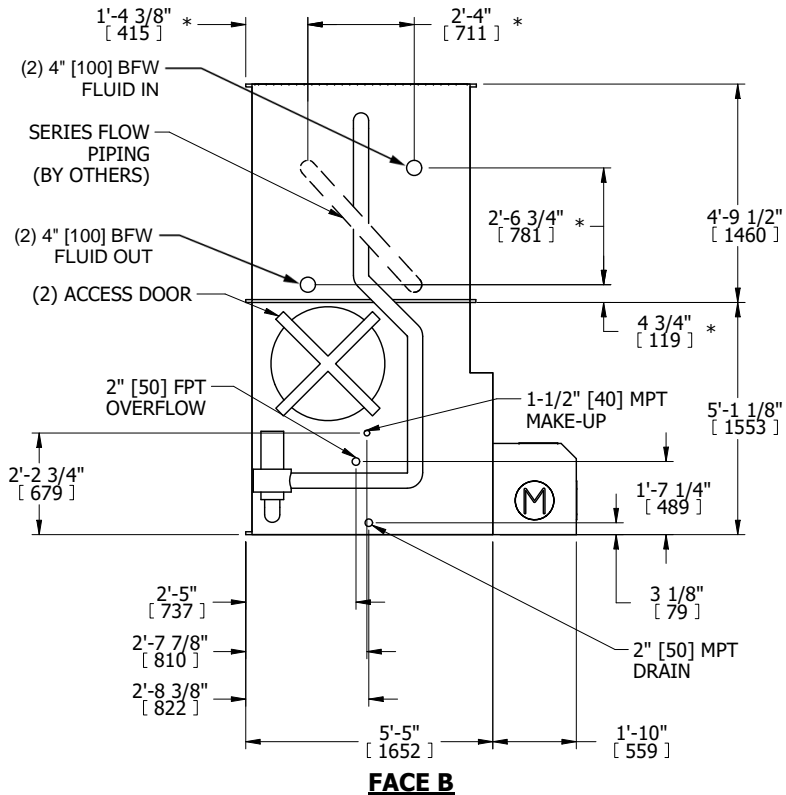
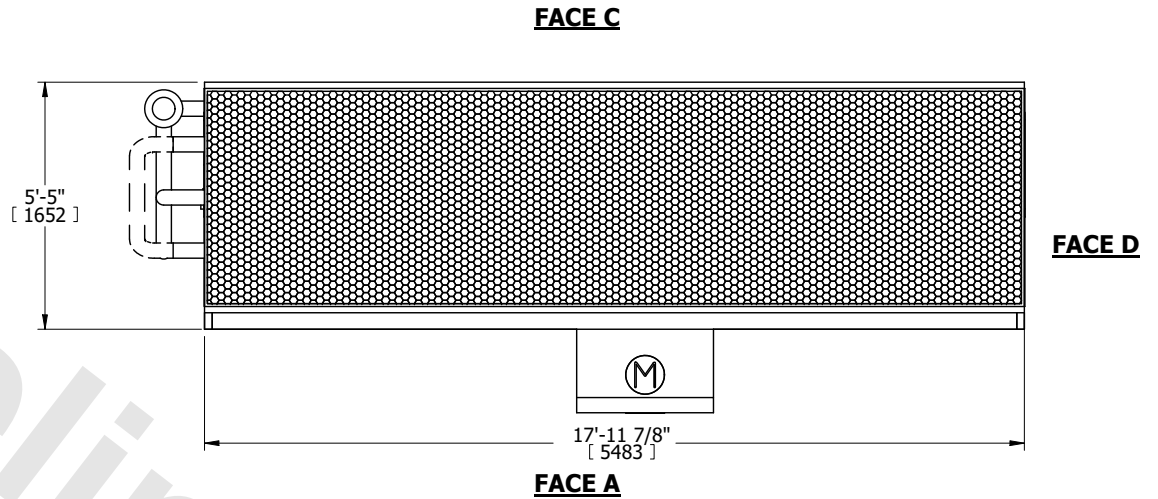

SHIPPING WEIGHT	13510 lbs+ [6130] kg+	OPERATING WEIGHT	18990 lbs+ [8615] kg+	HEAVIEST SECTION WEIGHT	9570 lbs+ [4345] kg+	NO. OF SHIPPING SECTIONS	2	DRAWN BY:	TLS
-----------------	-----------------------	------------------	-----------------------	-------------------------	----------------------	--------------------------	---	-----------	-----