

CONFIDENTIAL

This document is the property of Evapco, Inc. It should not be copied or disclosed without prior written authorization.

# EVAPCO, INC.



CUSTOMER	MODEL # SSTMB1-11103E0075F1LA	SCALE N.T.S.	DWG. # STMC1-SE-16	REV. 0	DATE 3/4/2025
----------	-------------------------------	--------------	--------------------	--------	---------------

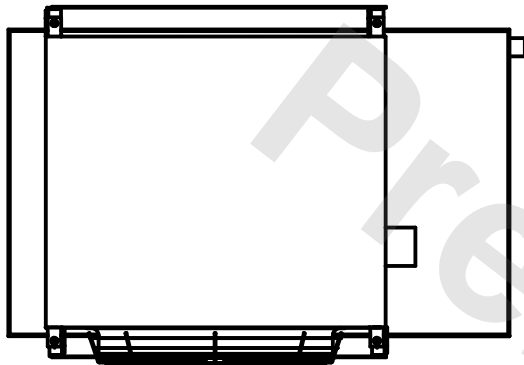

NOTES:

- 1) \* = HANGER HOLE LOCATION.
- 2) RIGHT HAND MODEL SHOWN.
- 3) HANGER HOLES ARE FOR 3/4 INCH THREADED ROD.
- 4) WATER DEFROST ADDS 1 3/4" INCHES TO HEIGHT OF STANDARD UNIT AND CHANGES DRAIN SIZE.
- 5) ALL DIMENSIONS ARE FOR REFERENCE AND SHOULD NOT BE USED FOR PREFABRICATION OF PIPING OR SUPPORTS.

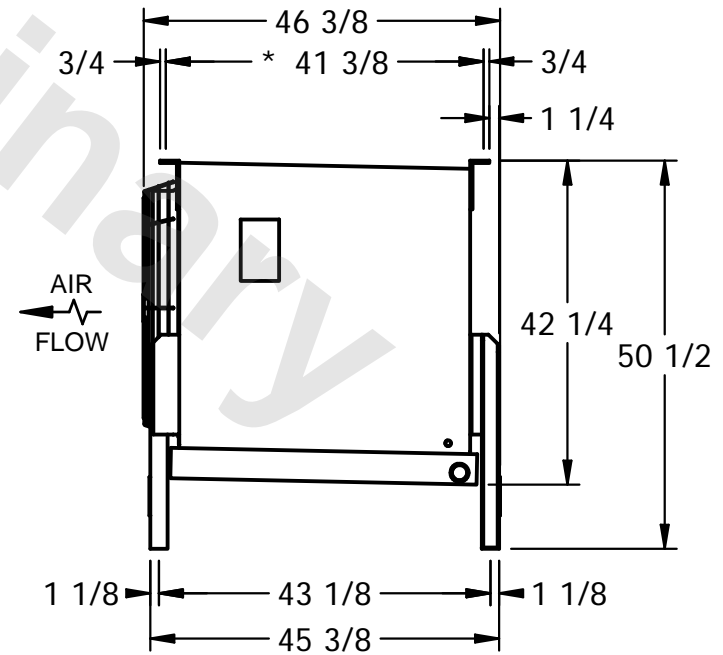
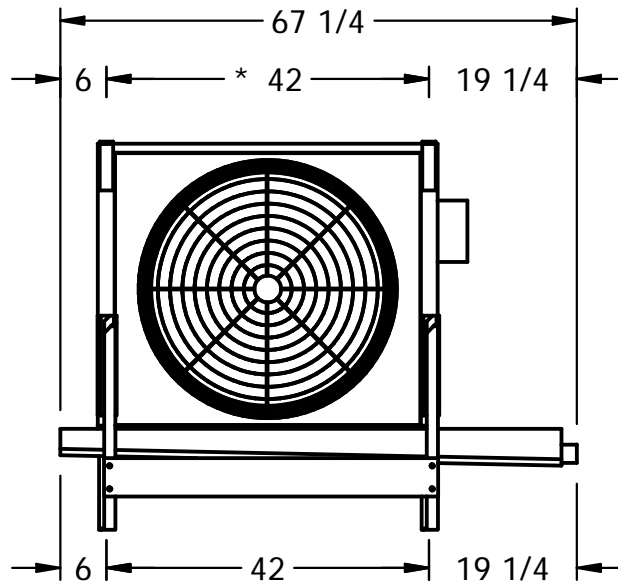

PROJECT	ROOM	SHIPPING WEIGHT 650 lbs	OPERATING WEIGHT 780 lbs
---------	------	-------------------------	--------------------------