

| | | |
|---------|------------------|-----------|
| UNIT | CONDENSER | |
| MODEL # | eco-ATC-293A | SCALE NTS |

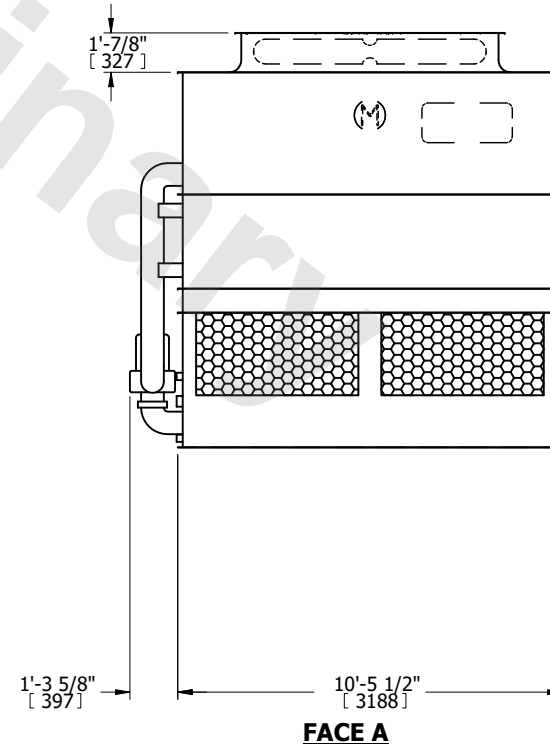

| | | | |
|----------|------------------|------|-----------|
| DWG. # | WB3091106-DRC-ST | REV. | - |
| SERIAL # | | DATE | 11/8/2024 |

- NOTES:
- (M)- FAN MOTOR LOCATION
 - HEAVIEST SECTION IS UPPER SECTION
 - MPT DENOTES MALE PIPE THREAD
FPT DENOTES FEMALE PIPE THREAD
BFW DENOTES BEVELED FOR WELDING
GVD DENOTES GROOVED
FLG DENOTES FLANGE
PE DENOTES PLAIN END
 - +UNIT WEIGHT DOES NOT INCLUDE ACCESSORIES (SEE ACCESSORY DRAWINGS)
 - MAKE-UP WATER PRESSURE
20 psi MIN [137 kPa], 50 psi MAX [344 kPa]
 - *-APPROXIMATE DIMENSIONS DO NOT USE FOR PRE-FABRICATION OF CONNECTING PIPING
 - 3/4" [19mm] DIA. MOUNTING HOLES. REFER TO RECOMMENDED STEEL SUPPORT DRAWING.
 - DIMENSIONS LISTED AS FOLLOWS:
ENGLISH FT-IN
METRIC [mm]

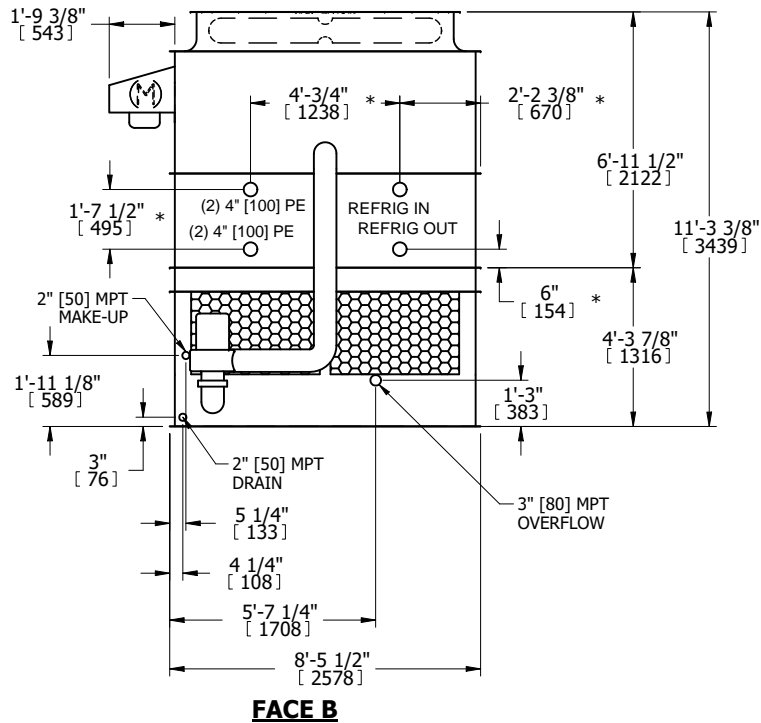
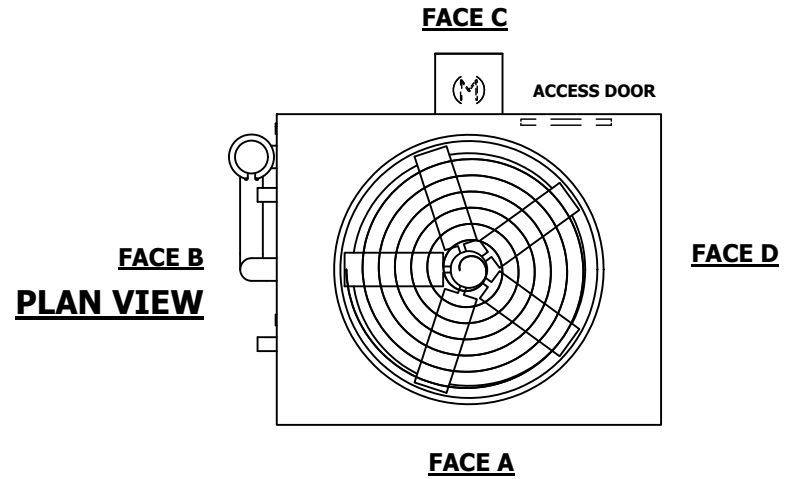

| | | | | | | | | | |
|-----------------|-----------------------|------------------|-----------------------|-------------------------|----------------------|--------------------------|---|-----------|-----|
| SHIPPING WEIGHT | 11050 lbs+ [5015] kg+ | OPERATING WEIGHT | 14500 lbs+ [6580] kg+ | HEAVIEST SECTION WEIGHT | 9410 lbs+ [4270] kg+ | NO. OF SHIPPING SECTIONS | 2 | DRAWN BY: | SLR |
|-----------------|-----------------------|------------------|-----------------------|-------------------------|----------------------|--------------------------|---|-----------|-----|