

UNIT	CONDENSER	
MODEL #	eco-ATC-146A	SCALE NTS

EVAPCO, INC.

DWG. #	WB3041208-DRE-ST	REV.	-
SERIAL #		DATE	11/4/2024

- NOTES:
- (M)- FAN MOTOR LOCATION
 - HEAVIEST SECTION IS UPPER SECTION
 - MPT DENOTES MALE PIPE THREAD
FPT DENOTES FEMALE PIPE THREAD
BFW DENOTES BEVELED FOR WELDING
GVD DENOTES GROOVED
FLG DENOTES FLANGE
PE DENOTES PLAIN END
 - +UNIT WEIGHT DOES NOT INCLUDE ACCESSORIES (SEE ACCESSORY DRAWINGS)
 - MAKE-UP WATER PRESSURE
20 psi MIN [137 kPa], 50 psi MAX [344 kPa]
 - *-APPROXIMATE DIMENSIONS DO NOT USE FOR PRE-FABRICATION OF CONNECTING PIPING
 - 3/4" [19mm] DIA. MOUNTING HOLES. REFER TO RECOMMENDED STEEL SUPPORT DRAWING.
 - DIMENSIONS LISTED AS FOLLOWS:
ENGLISH FT-IN
METRIC [mm]

FACE B
PLAN VIEW

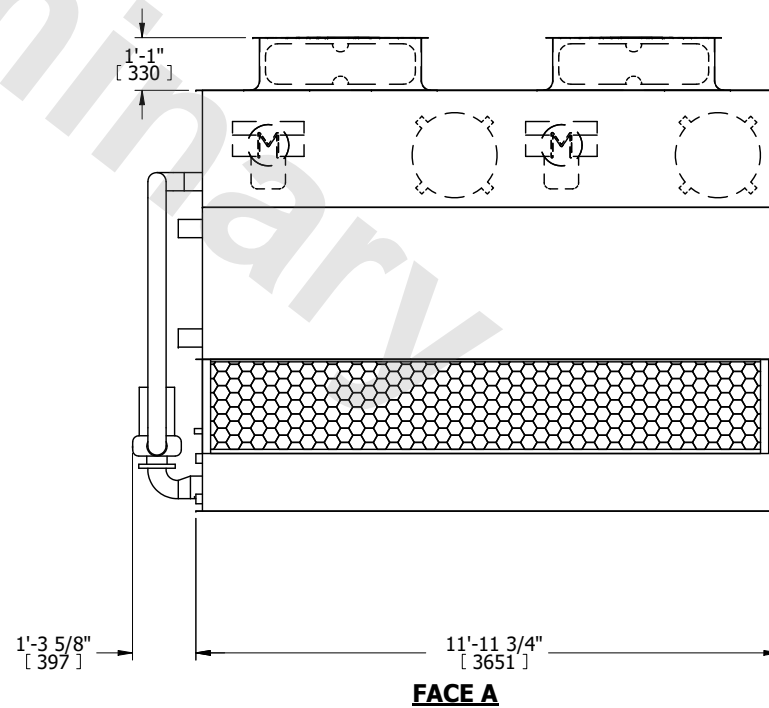
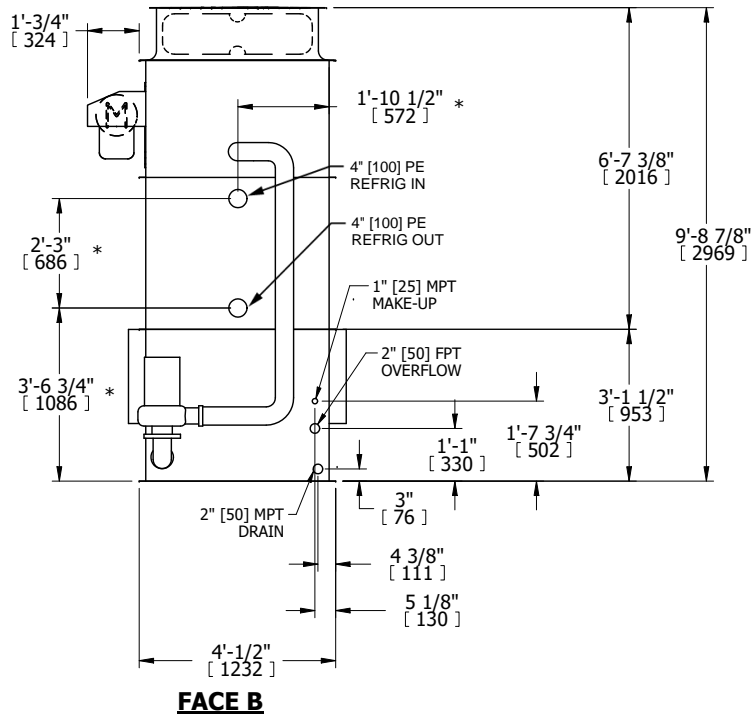
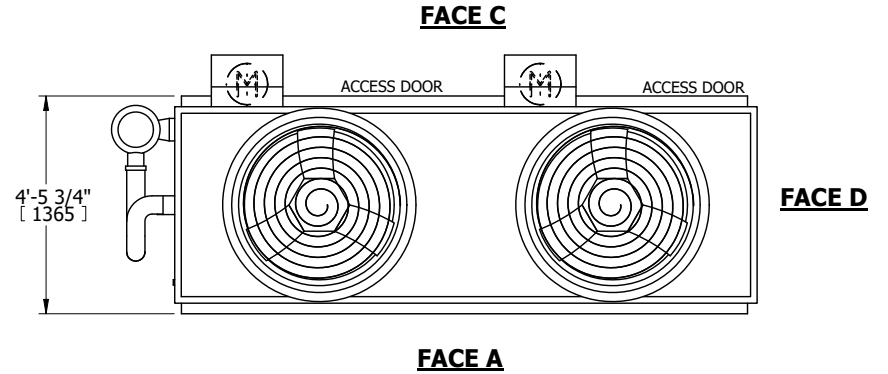

SHIPPING WEIGHT	6840 lbs+ [3105] kg+	OPERATING WEIGHT	9030 lbs+ [4100] kg+	HEAVIEST SECTION WEIGHT	6020 lbs+ [2735] kg+	NO. OF SHIPPING SECTIONS	2	DRAWN BY:	CAF
-----------------	----------------------	------------------	----------------------	-------------------------	----------------------	--------------------------	---	-----------	-----