

UNIT	COOLING TOWER	
MODEL #	AT 27-3M28	SCALE NTS



DWG. #	CT4C072836-DRA-ST	REV	-
SERIAL #		DATE:	10/4/2024

- NOTES:
- (M)- FAN MOTOR LOCATION
 - HEAVIEST SECTION IS FAN/CASING SECTION
 - MPT DENOTES MALE PIPE THREAD
FPT DENOTES FEMALE PIPE THREAD
BFW DENOTES BEVELED FOR WELDING
GVD DENOTES GROOVED
FLG DENOTES FLANGE
 - +UNIT WEIGHT DOES NOT INCLUDE ACCESSORIES (SEE ACCESSORY DRAWINGS)
 - 3/4" [19MM] DIA. MOUNTING HOLES. REFER TO RECOMMENDED STEEL SUPPORT DRAWING
 - DIMENSIONS LISTED AS FOLLOWS:
ENGLISH FT-IN
[METRIC] [mm]
 - MAKE-UP WATER PRESSURE
20 psi MIN [137 kPa], 50 psi MAX [344 kPa]

**FACE B
PLAN VIEW**

FACE C

FACE D

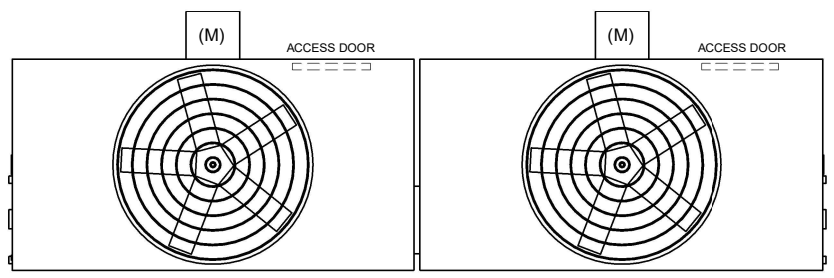

FACE A

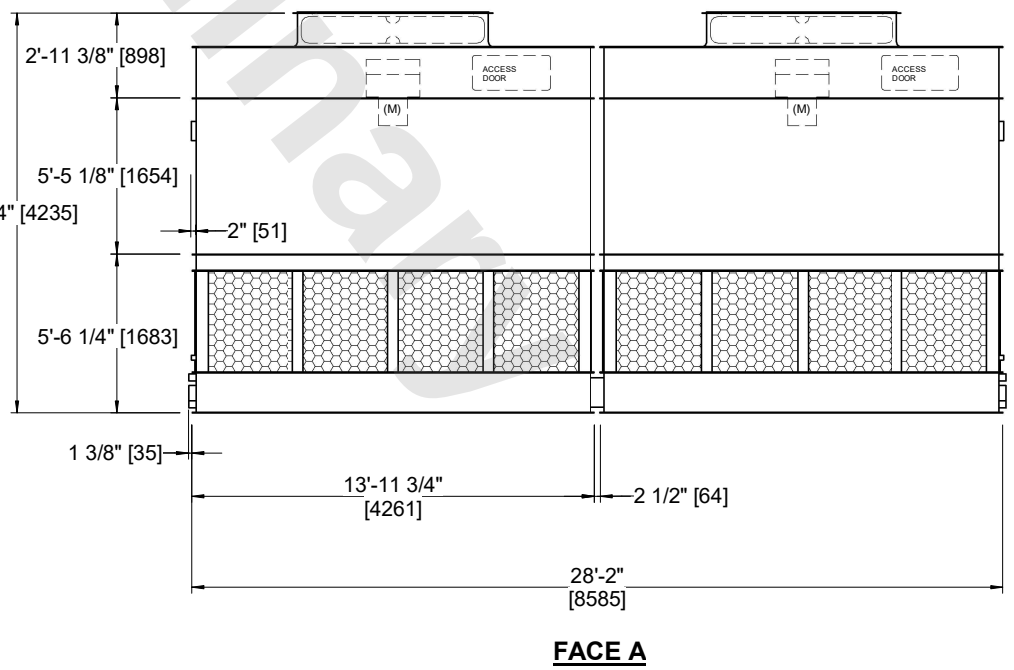
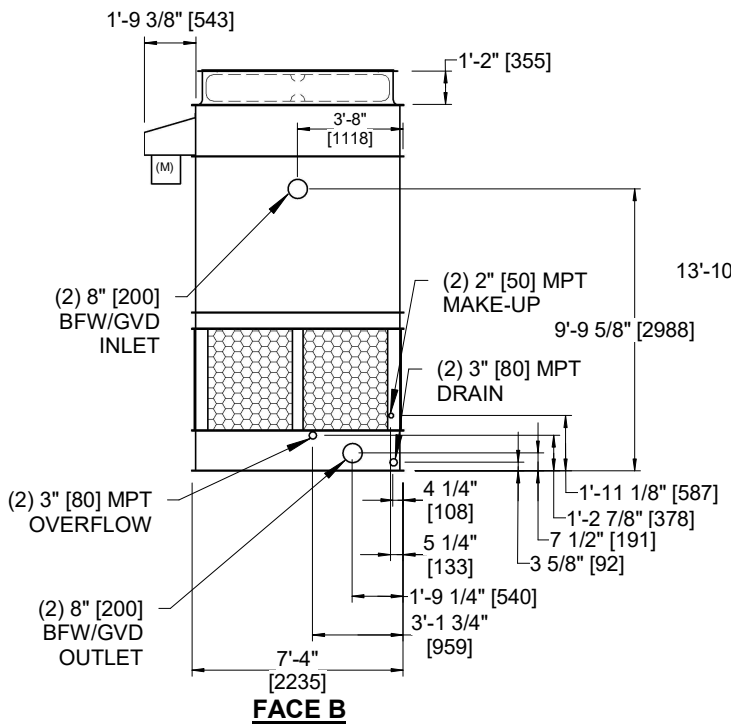

SHIPPING WEIGHT	11920 lbs+ [5410] kg+	OPERATING WEIGHT	19770 lbs+ [8970] kg+	HEAVIEST SECTION WEIGHT	3960 lbs+ [1800] kg+	NO. OF SHIPPING SECTIONS	4	DRAWN BY:	JLG
-----------------	-----------------------	------------------	-----------------------	-------------------------	----------------------	--------------------------	---	-----------	-----