

UNIT	COOLING TOWER	
MODEL #	AT 19-4J9	SCALE NTS

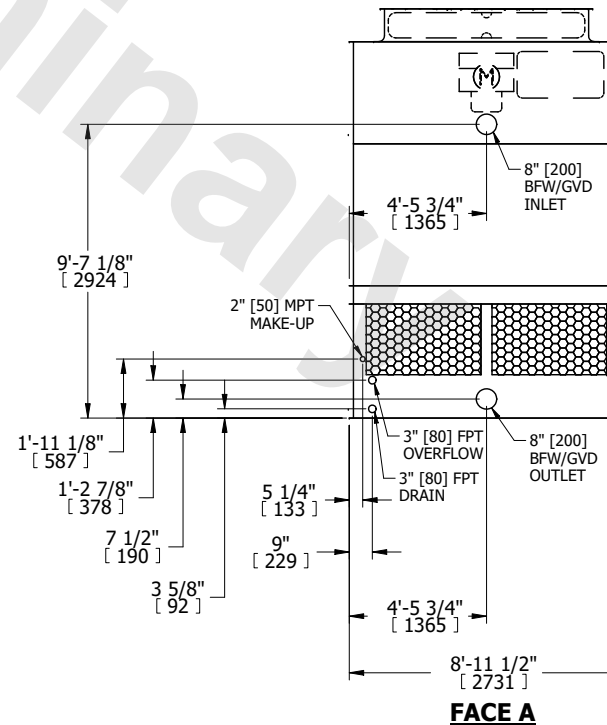

DWG. #	T3090948-DRD-ST	REV.	-
SERIAL #		DATE	10/8/2024

- NOTES:
- (M)- FAN MOTOR LOCATION
 - HEAVIEST SECTION IS UPPER SECTION
 - MPT DENOTES MALE PIPE THREAD
FPT DENOTES FEMALE PIPE THREAD
BFW DENOTES BEVELED FOR WELDING
GVD DENOTES GROOVED
FLG DENOTES FLANGE
 - +UNIT WEIGHT DOES NOT INCLUDE ACCESSORIES (SEE ACCESSORY DRAWINGS)
 - MAKE-UP WATER PRESSURE
20 psi MIN [137 kPa], 50 psi MAX [344 kPa]
 - 3/4" [19MM] DIA. MOUNTING HOLES. REFER TO RECOMENDED STEEL SUPPORT DRAWING.
 - DIMENSIONS LISTED AS FOLLOWS:
ENGLISH FT-IN
[METRIC] [mm]

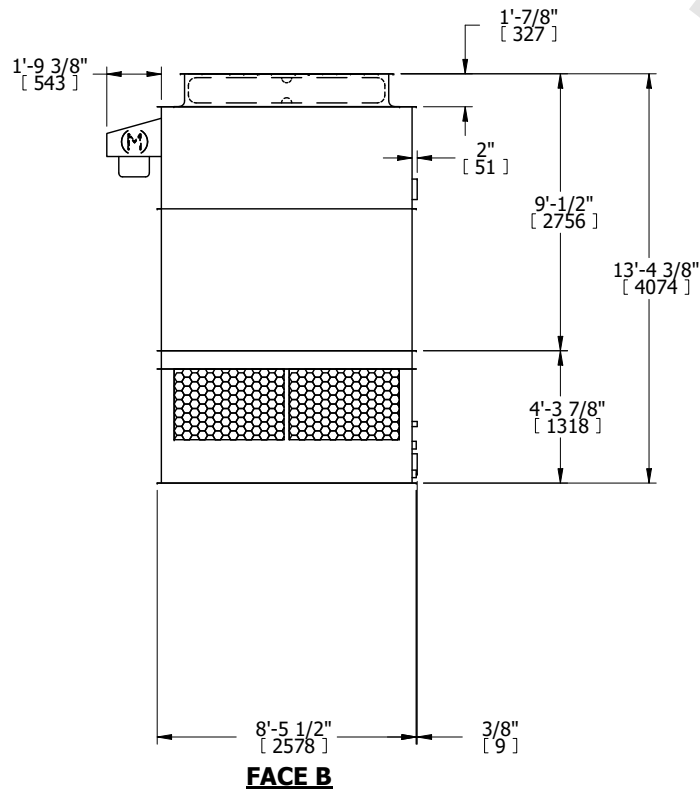
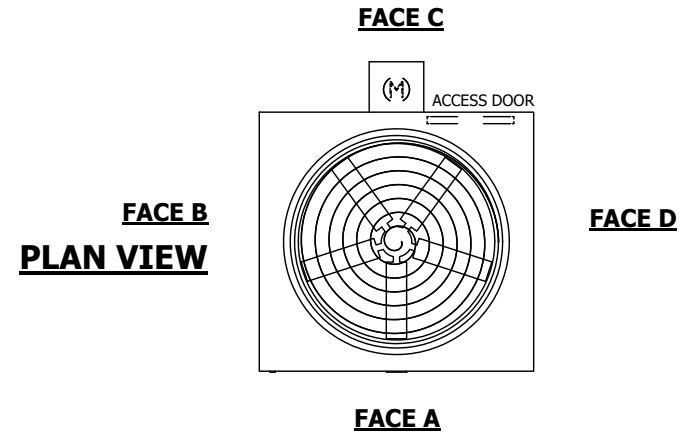

SHIPPING WEIGHT	4830 lbs+ [2195] kg+	OPERATING WEIGHT	7670 lbs+ [3480] kg+	HEAVIEST SECTION WEIGHT	3390 lbs+ [1540] kg+	NO. OF SHIPPING SECTIONS	2	DRAWN BY:	JLG
-----------------	----------------------	------------------	----------------------	-------------------------	----------------------	--------------------------	---	-----------	-----