

| | | |
|---------|---------------|-----------|
| UNIT | COOLING TOWER | |
| MODEL # | AT 220-4118 | SCALE NTS |

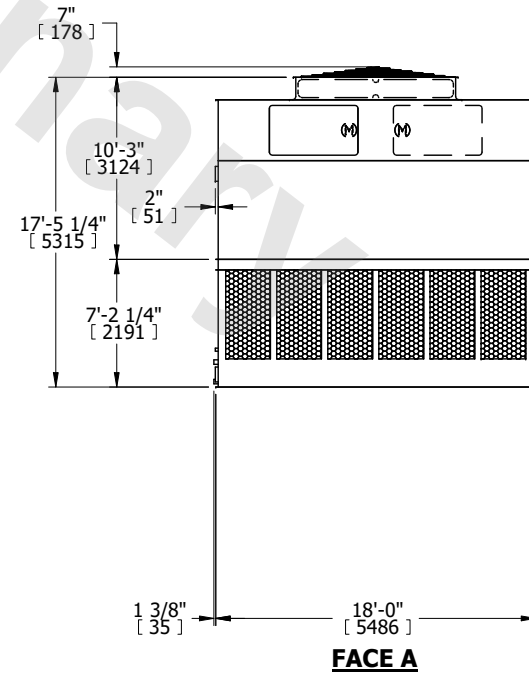

| | | | |
|----------|-----------------|------|-----------|
| DWG. # | T36M1848-DRF-ST | REV. | - |
| SERIAL # | | DATE | 9/20/2024 |

- NOTES:
- (M)- FAN MOTOR LOCATION
 - HEAVIEST SECTION IS UPPER SECTION
 - MPT DENOTES MALE PIPE THREAD
FPT DENOTES FEMALE PIPE THREAD
BFW DENOTES BEVELED FOR WELDING
GVD DENOTES GROOVED
FLG DENOTES FLANGE
 - +UNIT WEIGHT DOES NOT INCLUDE ACCESSORIES (SEE ACCESSORY DRAWINGS)
 - MAKE-UP WATER PRESSURE
20 psi MIN [137 kPa], 50 psi MAX [344 kPa]
 - 3/4" [19MM] DIA. MOUNTING HOLES.
REFER TO RECOMMENDED STEEL SUPPORT DRAWING
 - DIMENSIONS LISTED AS FOLLOWS:
ENGLISH FT-IN
[METRIC] [mm]

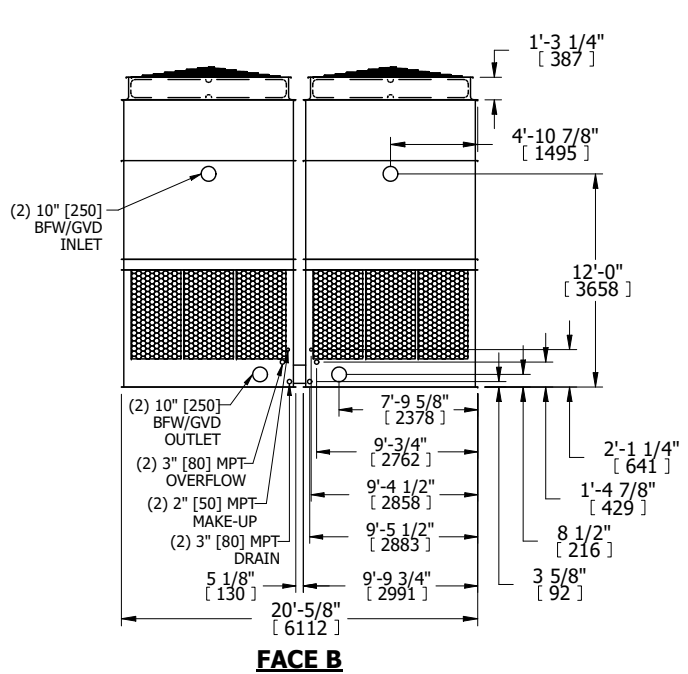
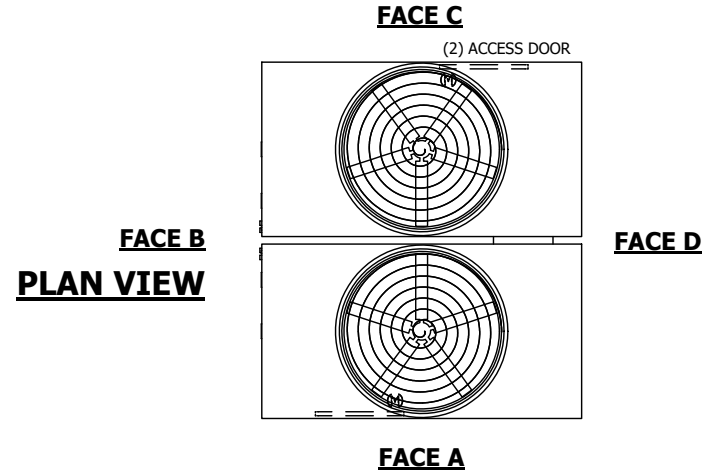

| | | | | | | | | | |
|-----------------|-----------------------|------------------|------------------------|-------------------------|----------------------|--------------------------|---|-----------|-----|
| SHIPPING WEIGHT | 21740 lbs+ [9865] kg+ | OPERATING WEIGHT | 36940 lbs+ [16760] kg+ | HEAVIEST SECTION WEIGHT | 6960 lbs+ [3160] kg+ | NO. OF SHIPPING SECTIONS | 4 | DRAWN BY: | KDS |
|-----------------|-----------------------|------------------|------------------------|-------------------------|----------------------|--------------------------|---|-----------|-----|