

UNIT	COOLING TOWER	
MODEL #	AT 342-5M26	SCALE NTS

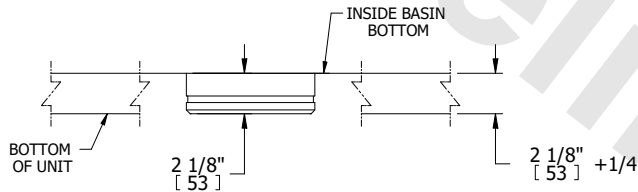

DWG. #	T3BI422660-DRD-ST	REV.	-
SERIAL #		DATE	3/16/2025

- NOTES:
- (M)- FAN MOTOR LOCATION
  - HEAVIEST SECTION IS UPPER SECTION
  - MPT DENOTES MALE PIPE THREAD  
FPT DENOTES FEMALE PIPE THREAD  
BFW DENOTES BEVELED FOR WELDING  
GVD DENOTES GROOVED  
FLG DENOTES FLANGE
  - +UNIT WEIGHT DOES NOT INCLUDE ACCESSORIES (SEE ACCESSORY DRAWINGS)
  - MAKE-UP WATER PRESSURE  
20 psi MIN [137 kPa], 50 psi MAX [344 kPa]
  - PAN EQUALIZER PIPING IS SUPPLIED BY OTHERS, FLUME SUPPLIED BY EVAPCO.
  - FOR BOTTOM CONNECTION SPECIFICATIONS, SEE DETAIL.
  - 3/4" [19mm] DIA. MOUNTING HOLES. REFER TO RECOMMENDED STEEL SUPPORT DRAWING
  - DIMENSIONS LISTED AS FOLLOWS:  
ENGLISH FT-IN  
[METRIC] [mm]



**TYPICAL BOTTOM CONNECTION DETAIL**

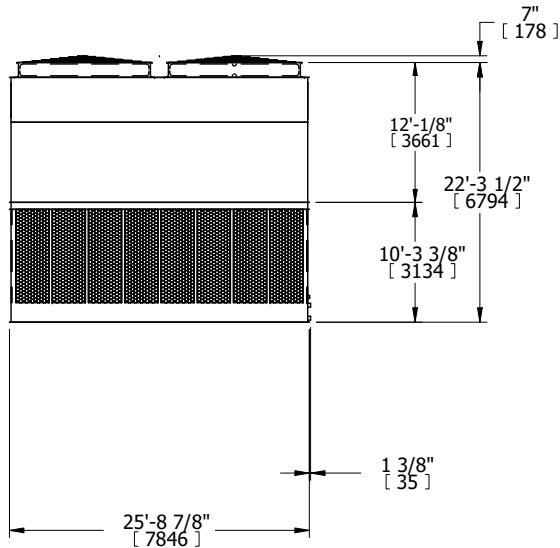

**FACE B**

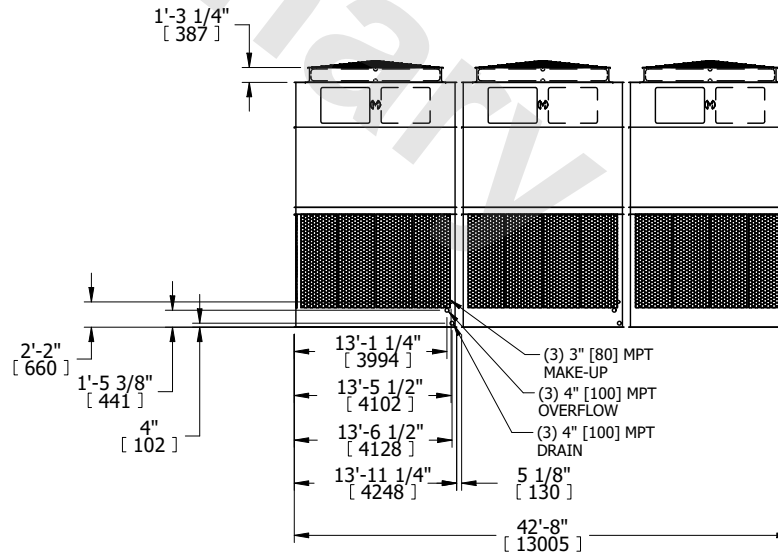

**FACE A**

**FACE B  
PLAN VIEW**

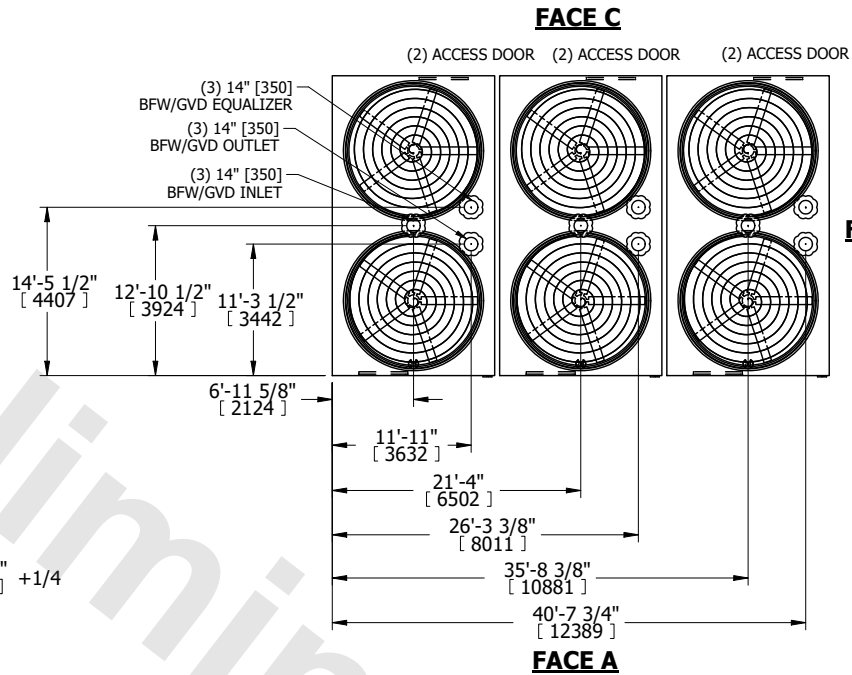

**FACE C**

**FACE D**

SHIPPING WEIGHT	73890 lbs+ [33520] kg+	OPERATING WEIGHT	124890 lbs+ [56650] kg+	HEAVIEST SECTION WEIGHT	17820 lbs+ [8085] kg+	NO. OF SHIPPING SECTIONS	6	DRAWN BY:	SLR
-----------------	------------------------	------------------	-------------------------	-------------------------	-----------------------	--------------------------	---	-----------	-----