

UNIT	CONDENSER	
MODEL #	PMRC-1127	SCALE NTS

# EVAPCO, INC.

DWG. #	CEWR122410-DRA-ST	REV	-
SERIAL #		DATE:	10/18/2024

- NOTES:**
1. (M) - FAN MOTOR LOCATION
  2. HEAVIEST SECTION IS UPPER SECTION
  3. MPT DENOTES MALE PIPE THREAD  
FPT DENOTES FEMALE PIPE THREAD  
BFW DENOTES BEVELED FOR WELDING
  4. +UNIT WEIGHT DOES NOT INCLUDE ACCESSORIES (SEE ACCESSORY DRAWINGS)
  5. 3/4" DIA. MOUNTING HOLES. REFER TO RECOMMENDED STEEL SUPPORT DRAWING.
  6. MAKE-UP WATER PRESSURE  
20 psi MIN [137 kPa], 50 psi MAX [344 kPa]
  7. \*- APPROXIMATE DIMENSIONS DO NOT USE FOR PRE-FABRICATION OF CONNECTING PIPING
  8. DIMENSIONS LISTED AS FOLLOWS: ENGLISH IN [METRIC] [mm]

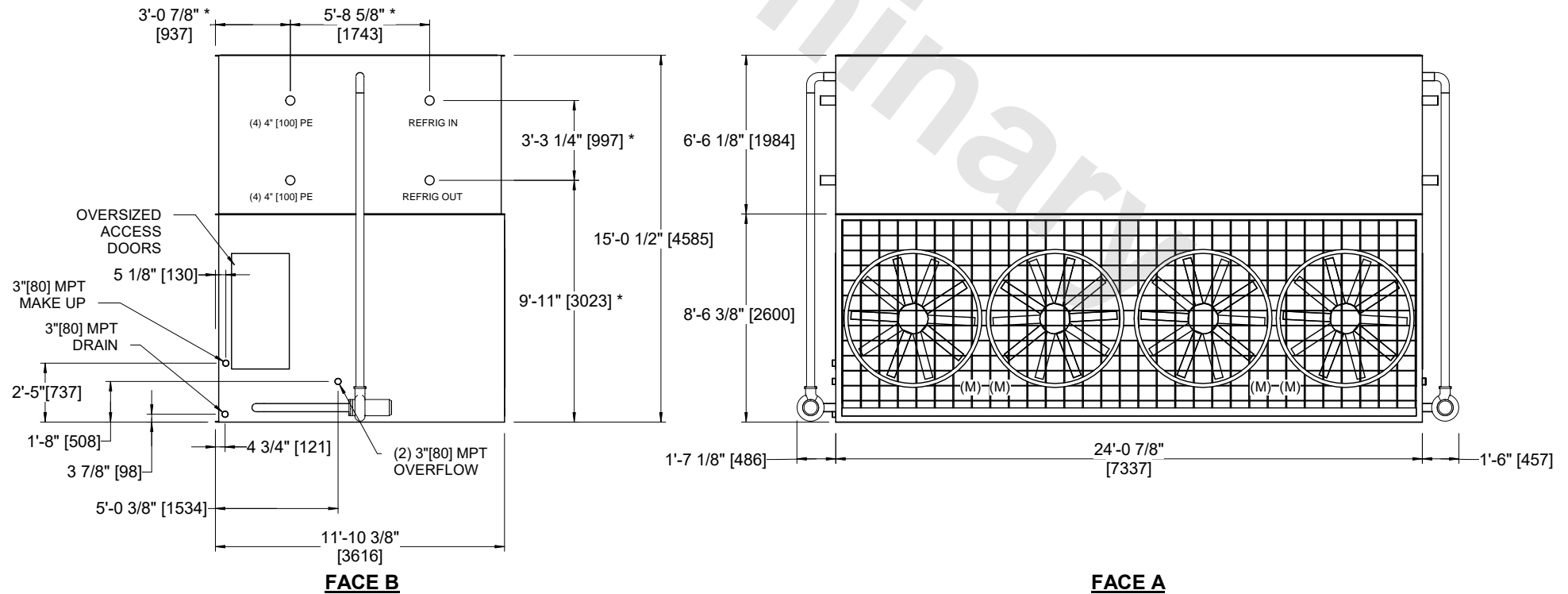

SHIPPING WEIGHT	40360 lbs+ [18310] kg+	OPERATING WEIGHT	50400 lbs+ [22865] kg+	HEAVIEST SECTION WEIGHT	14530 lbs+ [6595] kg+	NO. OF SHIPPING SECTIONS	3	DRAWN BY:	JLG
-----------------	------------------------	------------------	------------------------	-------------------------	-----------------------	--------------------------	---	-----------	-----