

UNIT	CONDENSER	
MODEL #	PMRC-376	SCALE NTS

EVAPCO, INC.

DWG. #	CEWR121206-DRA-ST	REV	-
SERIAL #		DATE:	10/19/2024

- NOTES:**
1. (M) - FAN MOTOR LOCATION
 2. HEAVIEST SECTION IS UPPER SECTION
 3. MPT DENOTES MALE PIPE THREAD
FPT DENOTES FEMALE PIPE THREAD
BFW DENOTES BEVELED FOR WELDING
 4. +UNIT WEIGHT DOES NOT INCLUDE ACCESSORIES (SEE ACCESSORY DRAWINGS)
 5. 3/4" DIA. MOUNTING HOLES. REFER TO RECOMMENDED STEEL SUPPORT DRAWING.
 6. MAKE-UP WATER PRESSURE
20 psi MIN [137 kPa], 50 psi MAX [344 kPa]
 7. - APPROXIMATE DIMENSIONS DO NOT USE FOR PRE-FABRICATION OF CONNECTING PIPING
 8. DIMENSIONS LISTED AS FOLLOWS: ENGLISH IN [METRIC] [mm]

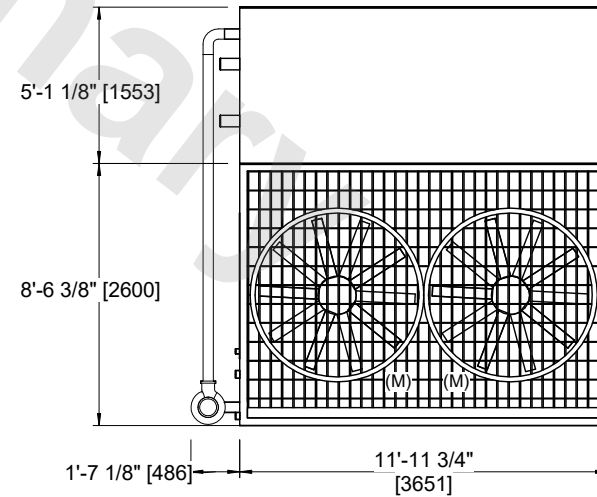
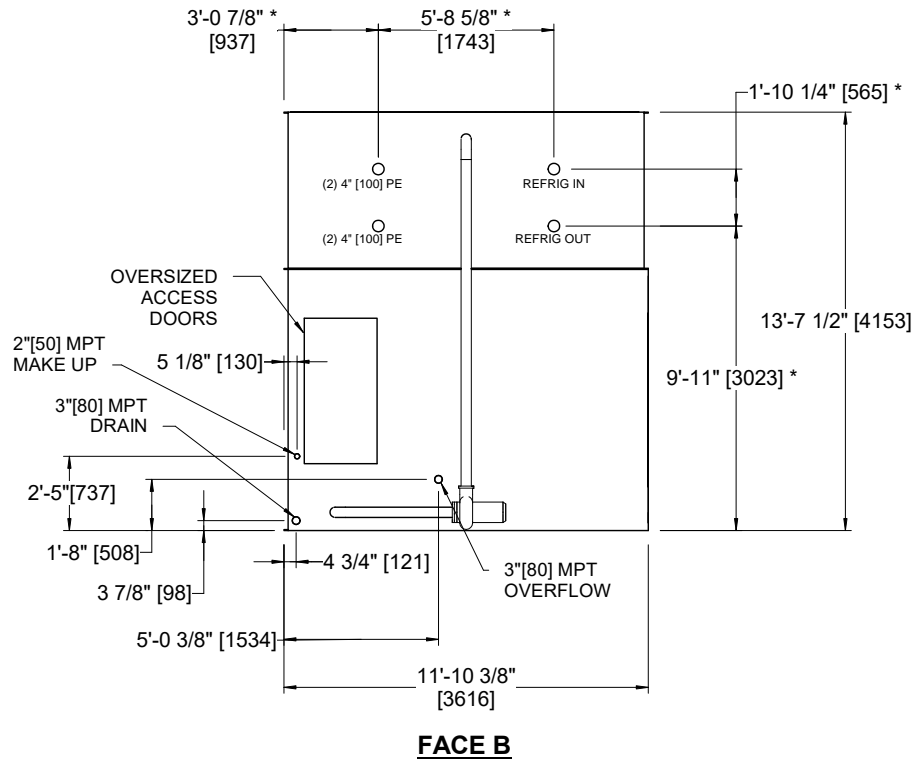
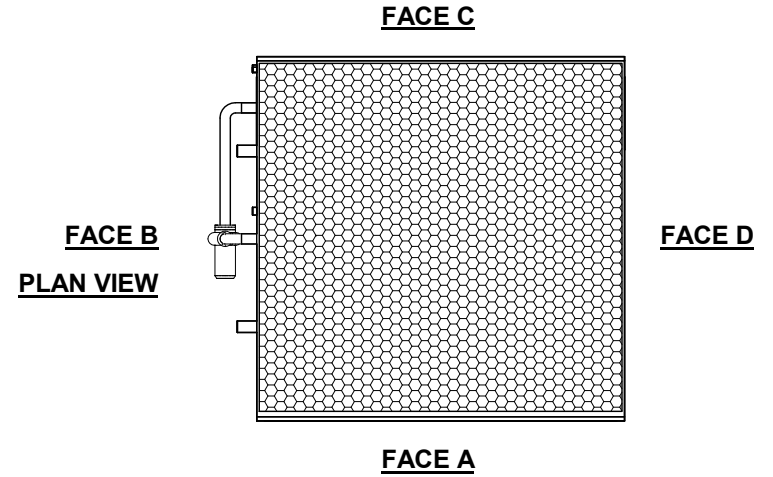

SHIPPING WEIGHT	15550 lbs+ [7055] kg+	OPERATING WEIGHT	20240 lbs+ [9185] kg+	HEAVIEST SECTION WEIGHT	9970 lbs+ [4525] kg+	NO. OF SHIPPING SECTIONS	2	DRAWN BY:	JLG
-----------------	-----------------------	------------------	-----------------------	-------------------------	----------------------	--------------------------	---	-----------	-----