

UNIT	COOLING TOWER	
MODEL #	AT 212-3M40	SCALE NTS

EVAPCO, INC.



DWG. #	T3124036-DRB-ST	REV.	-
SERIAL #		DATE	10/3/2024

- NOTES:**
- (M)- FAN MOTOR LOCATION
 - HEAVIEST SECTION IS UPPER SECTION
 - MPT DENOTES MALE PIPE THREAD
FPT DENOTES FEMALE PIPE THREAD
BFW DENOTES BEVELED FOR WELDING
GVD DENOTES GROOVED
FLG DENOTES FLANGE
 - +UNIT WEIGHT DOES NOT INCLUDE ACCESSORIES (SEE ACCESSORY DRAWINGS)
 - MAKE-UP WATER PRESSURE
20 psi MIN [137 kPa], 50 psi MAX [344 kPa]
 - 3/4" [19MM] DIA. MOUNTING HOLES. REFER TO RECOMENDED STEEL SUPPORT DRAWING.
 - DIMENSIONS LISTED AS FOLLOWS:
ENGLISH FT-IN
[METRIC] [mm]

**FACE B
PLAN VIEW**



FACE D

FACE A



FACE B

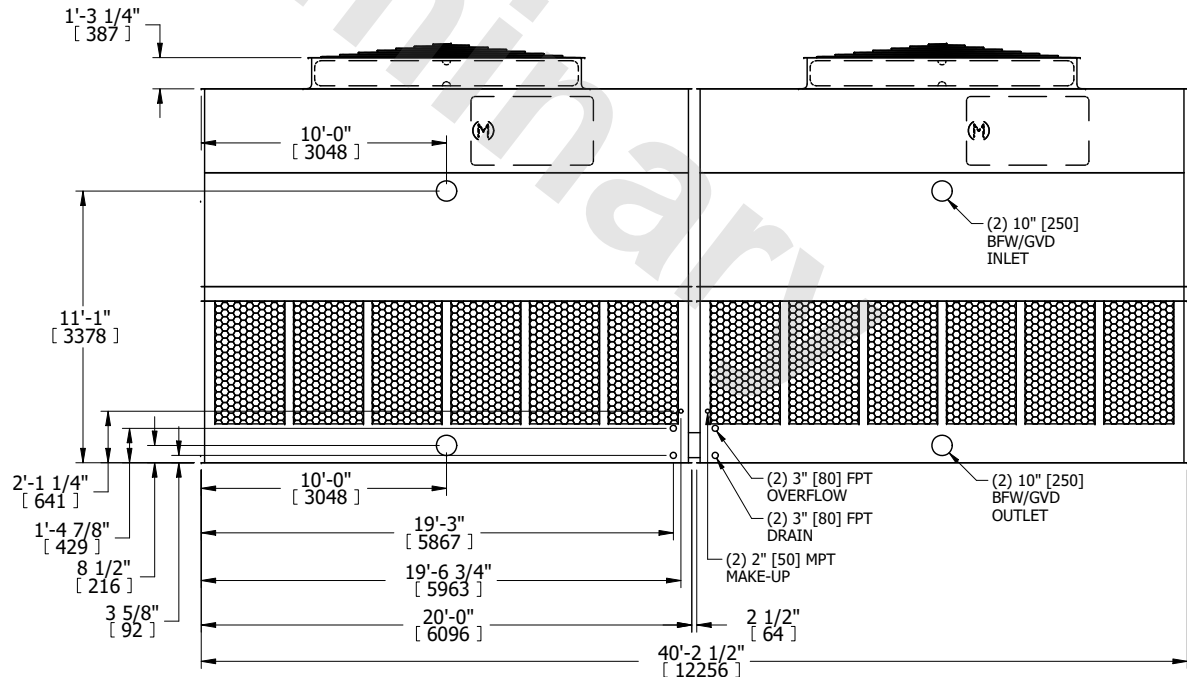

FACE A

SHIPPING WEIGHT	24720 lbs+ [11215] kg+	OPERATING WEIGHT	45520 lbs+ [20650] kg+	HEAVIEST SECTION WEIGHT	8100 lbs+ [3675] kg+	NO. OF SHIPPING SECTIONS	4	DRAWN BY:	BLL
-----------------	------------------------	------------------	------------------------	-------------------------	----------------------	--------------------------	---	-----------	-----