

| | | |
|---------|-----------------------|-----------|
| UNIT | CLOSED CIRCUIT COOLER | |
| MODEL # | LRWB 5-4L12 | SCALE NTS |

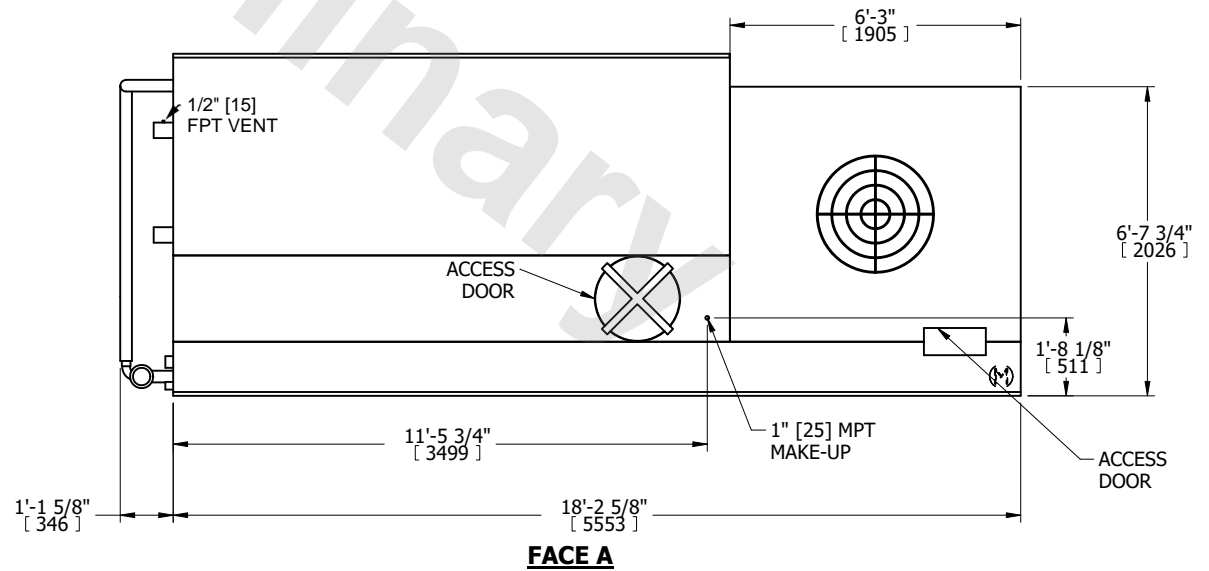

| | | | |
|----------|-----------------|------|-----------|
| DWG. # | WV051208-DRC-ST | REV. | - |
| SERIAL # | | DATE | 11/5/2024 |

- NOTES:
1. (M)- FAN MOTOR LOCATION
 2. MPT DENOTES MALE PIPE THREAD
FPT DENOTES FEMALE PIPE THREAD
BFW DENOTES BEVELED FOR WELDING
GVD DENOTES GROOVED
FLG DENOTES FLANGE
PE DENOTES PLAIN END
 3. +UNIT WEIGHT DOES NOT INCLUDE ACCESSORIES (SEE ACCESSORY DRAWINGS)
 4. 3/4" [19mm] DIA. MOUNTING HOLES. REFER TO RECOMMENDED STEEL SUPPORT DRAWING
 5. DIMENSIONS LISTED AS FOLLOWS: ENGLISH FT IN [METRIC] [mm]
 6. * - APPROXIMATE DIMENSIONS DO NOT USE FOR PRE-FABRICATION OF CONNECTING PIPING
 7. MAKE-UP WATER PRESSURE
20 psi [137 kPa] MIN, 50 psi [344 kPa] MAX

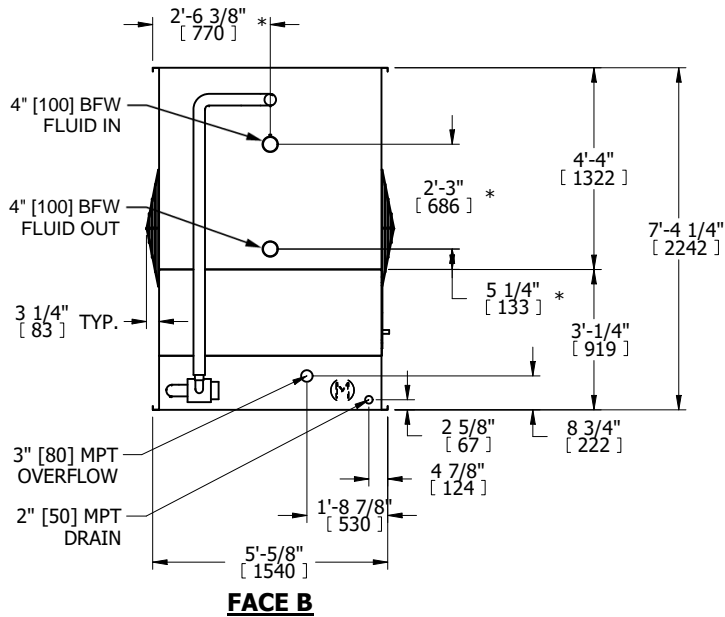
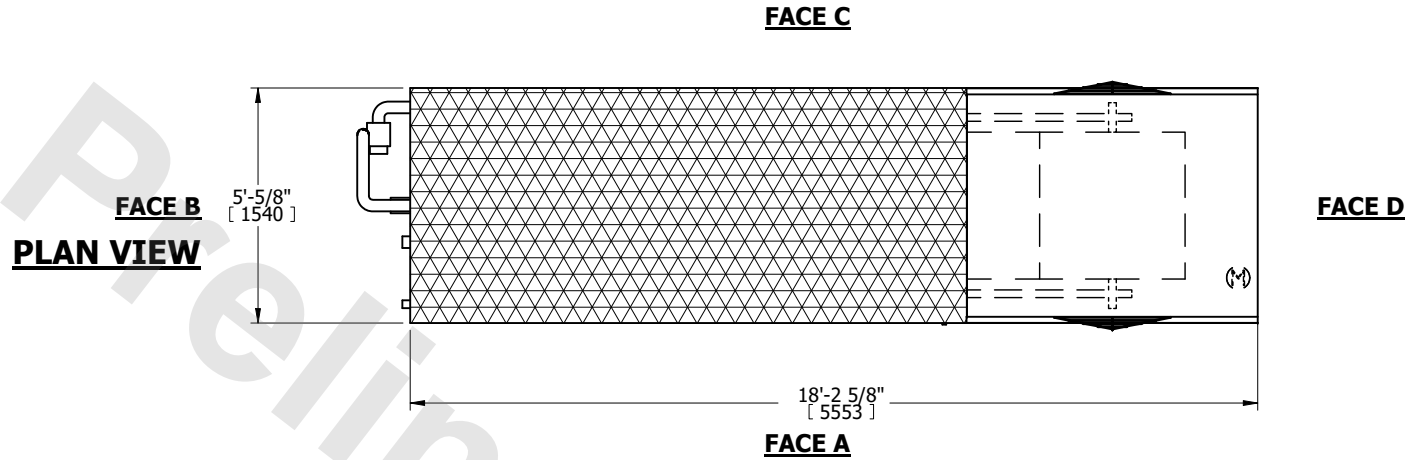

| | | | | | | | | | |
|-----------------|----------------------|------------------|-----------------------|-------------------------|----------------------|--------------------------|---|-----------|-----|
| SHIPPING WEIGHT | 7050 lbs+ [3200] kg+ | OPERATING WEIGHT | 11950 lbs+ [5425] kg+ | HEAVIEST SECTION WEIGHT | 7050 lbs+ [3200] kg+ | NO. OF SHIPPING SECTIONS | 1 | DRAWN BY: | TLS |
|-----------------|----------------------|------------------|-----------------------|-------------------------|----------------------|--------------------------|---|-----------|-----|