

UNIT	CLOSED CIRCUIT COOLER	
MODEL #	eco-ATWB 10-5L24-Z	SCALE NTS



DWG. #	WB3TM2410-DRC-SF	REV.	-
SERIAL #		DATE	11/5/2024

NOTES:

- (M)- FAN MOTOR LOCATION
- HEAVIEST SECTION IS UPPER SECTION
- MPT DENOTES MALE PIPE THREAD
FPT DENOTES FEMALE PIPE THREAD
BFW DENOTES BEVELED FOR WELDING
GVD DENOTES GROOVED
FLG DENOTES FLANGE
PE DENOTES PLAIN END
- +UNIT WEIGHT DOES NOT INCLUDE ACCESSORIES (SEE ACCESSORY DRAWINGS)
- MAKE-UP WATER PRESSURE
20 psi MIN [137 kPa], 50 psi MAX [344 kPa]
- *-APPROXIMATE DIMENSIONS DO NOT USE FOR PRE-FABRICATION OF CONNECTING PIPING
- SERIES FLOW PIPING AND AUX. CROSSOVER DRAIN BY OTHERS.
- 3/4" [19MM] DIA. MOUNTING HOLES. REFER TO RECOMMENDED STEEL SUPPORT DRAWING.
- DIMENSIONS LISTED AS FOLLOWS:

ENGLISH FT-IN
METRIC [mm]

**FACE B
PLAN VIEW**

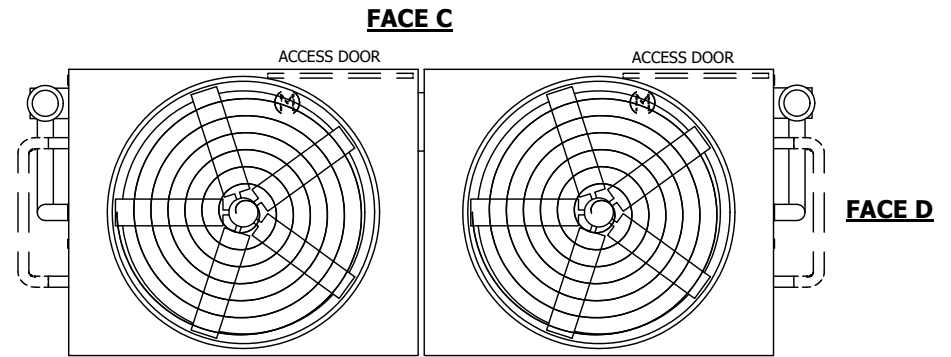

FACE A

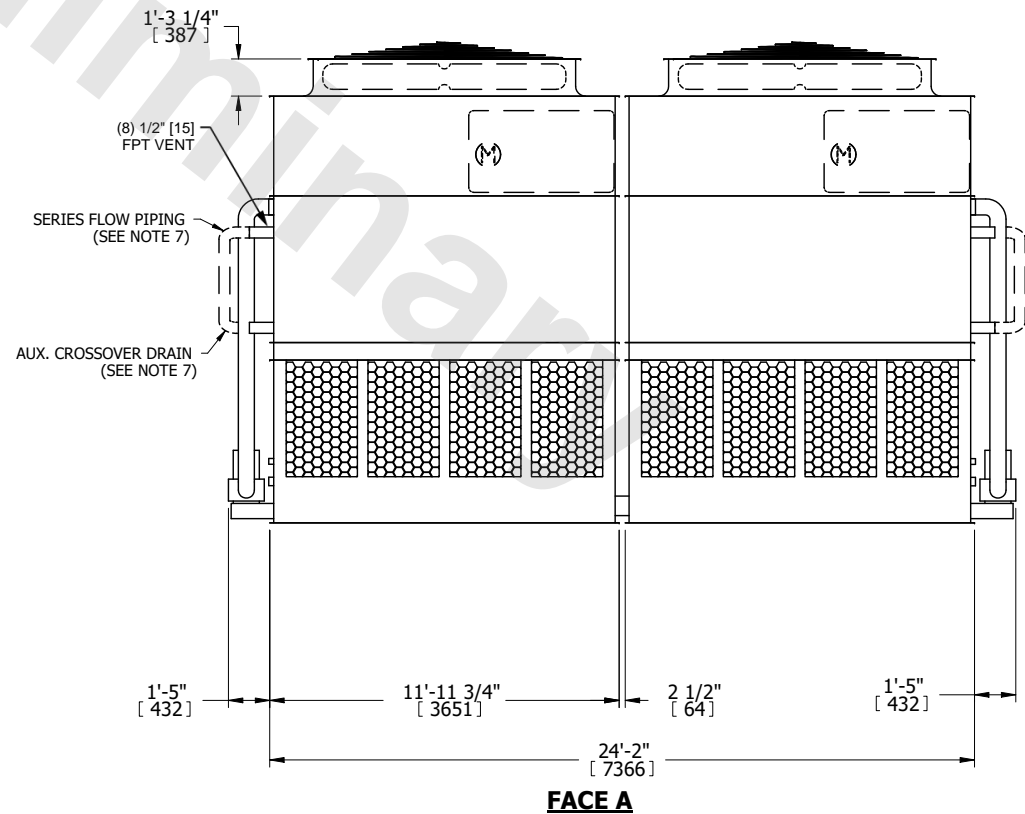
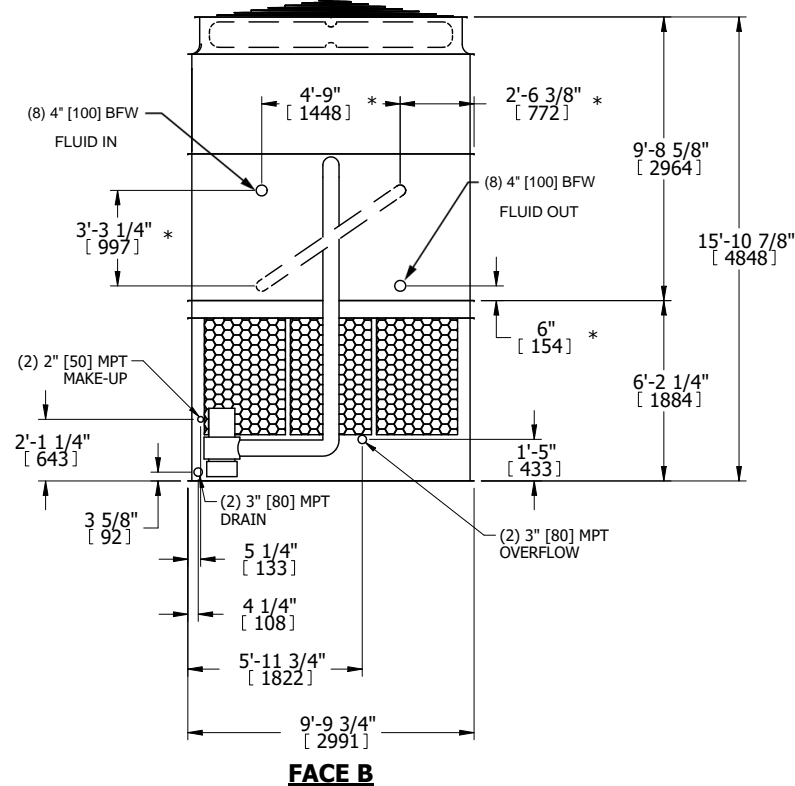

SHIPPING WEIGHT	39780 lbs+ [18045] kg+	OPERATING WEIGHT	57680 lbs+ [26165] kg+	HEAVIEST SECTION WEIGHT	17340 lbs+ [7870] kg+	NO. OF SHIPPING SECTIONS	4	DRAWN BY:	TLM
-----------------	------------------------	------------------	------------------------	-------------------------	-----------------------	--------------------------	---	-----------	-----