

EVAPCO, INC.



| | | | | | | |
|--------------------------------------|---------------------|-------|----------------------------|-----------|-------------------|----------|
| UNIT EVAPORATIVE CONDENSER | MODEL # PHC-S357 | SCALE | DWG. # HCS121214-DRC-ST | REV. - | DATE 11/1/2024 | SERIAL # |
|--------------------------------------|---------------------|-------|----------------------------|-----------|-------------------|----------|

NOTES:

- (M)- FAN MOTOR LOCATION
- HEAVIEST SECTION IS UPPER SECTION
- MPT DENOTES MALE PIPE THREAD
FPT DENOTES FEMALE PIPE THREAD
BFW DENOTES BEVELED FOR WELDING
GVD DENOTES GROOVED
- +UNIT WEIGHT DOES NOT INCLUDE ACCESSORIES (SEE ACCESSORY DRAWINGS)
- MAKE-UP WATER PRESSURE
20 psi MIN [137 kPa], 50 psi MAX [344 kPa]
- 3/4" DIA. MOUNTING HOLES. REFER TO RECOMMENDED STEEL SUPPORT DRAWING.
- *- APPROXIMATE DIMENSIONS DO NOT USE FOR PRE-FABRICATION OF CONNECTION PIPING.
- **-UNITS WITH 20HP PER FAN REQUIRE A TALLER FAN CYLINDER, ADD 5" TO THESE DIMENSIONS.
- DIMENSIONS LISTED AS FOLLOWS: ENGLISH IN [METRIC] [mm]

**FACE 2
PLAN VIEW**

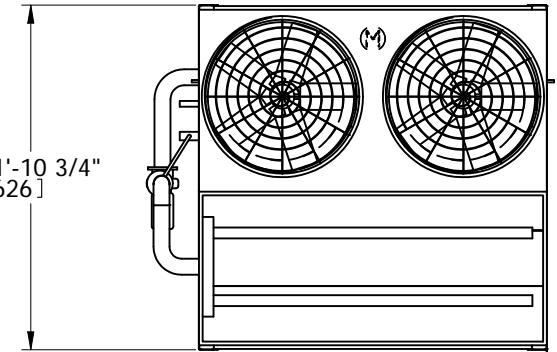

FACE 1

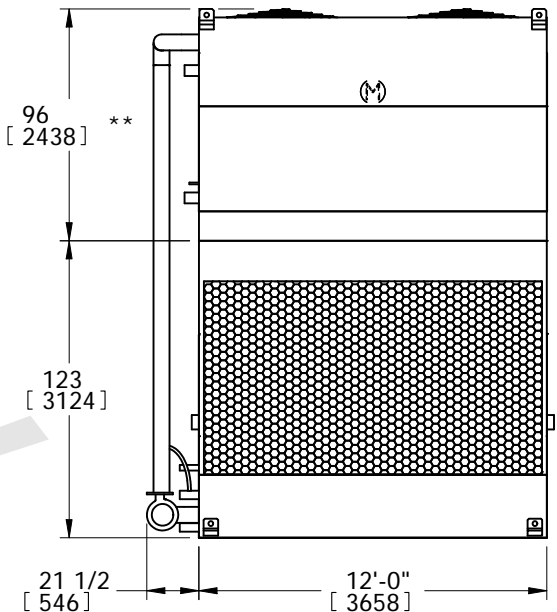

FACE 1

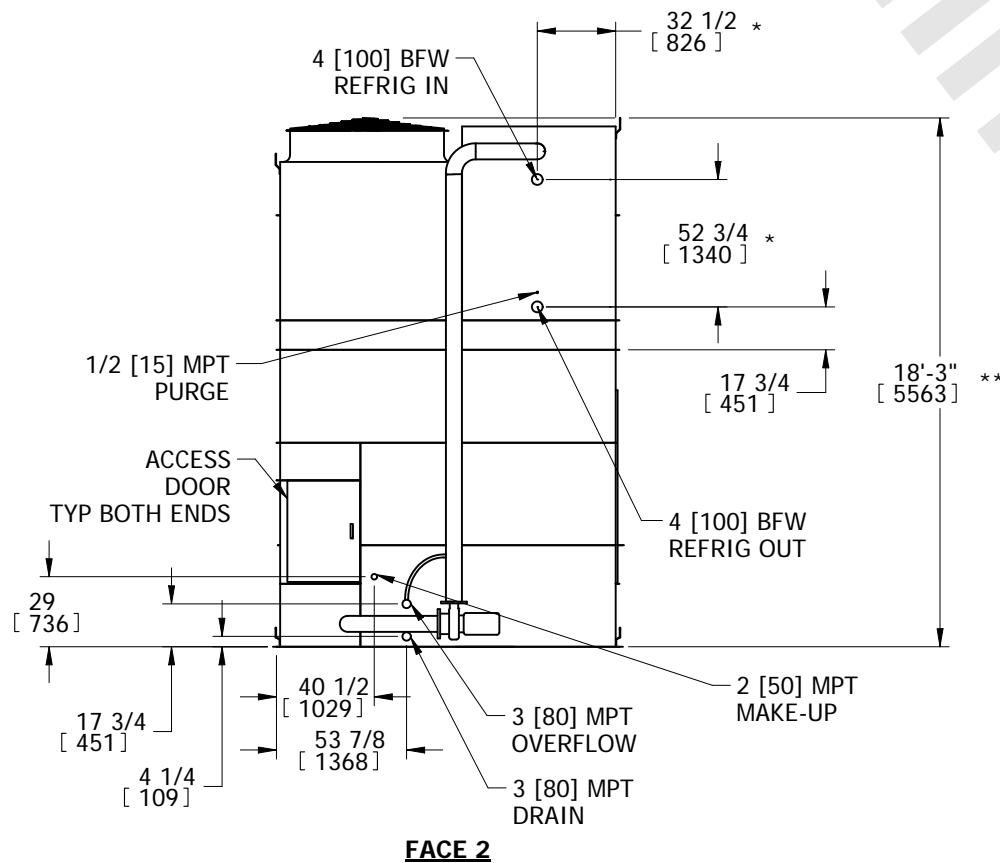

FACE 2

| | | | | |
|--|--|--|-------------------------------|------------------|
| SHIPPING WEIGHT 16620 lbs+ [7540] kg+ | OPERATING WEIGHT 22230 lbs+ [10085] kg+ | HEAVIEST SECTION WEIGHT 11460 lbs+ [5200] kg+ | NO. OF SHIPPING SECTIONS 2 | DRAWN BY: TLS |
|--|--|--|-------------------------------|------------------|