

EVAPCO, INC.



UNIT EVAPORATIVE CONDENSER	MODEL # PHC-L566	SCALE	DWG. # HCS1224S08-DRC-ST	REV. -	DATE 11/2/2024	SERIAL #
--------------------------------------	---------------------	-------	-----------------------------	-----------	-------------------	----------

NOTES:

- (M)- FAN MOTOR LOCATION
- HEAVIEST SECTION IS UPPER SECTION
- MPT DENOTES MALE PIPE THREAD
FPT DENOTES FEMALE PIPE THREAD
BFW DENOTES BEVELED FOR WELDING
GVD DENOTES GROOVED
- +UNIT WEIGHT DOES NOT INCLUDE ACCESSORIES (SEE ACCESSORY DRAWINGS)
- MAKE-UP WATER PRESSURE
20 psi MIN [137 kPa], 50 psi MAX [344 kPa]
- 3/4" DIA. MOUNTING HOLES. REFER TO RECOMMENDED STEEL SUPPORT DRAWING.
- *- APPROXIMATE DIMENSIONS DO NOT USE FOR PRE-FABRICATION OF CONNECTION PIPING.
- **-UNITS WITH 20HP PER FAN REQUIRE A TALLER FAN CYLINDER, ADD 5" TO THESE DIMENSIONS.
- DIMENSIONS LISTED AS FOLLOWS: ENGLISH IN [METRIC] [mm]

**FACE 2
PLAN VIEW**

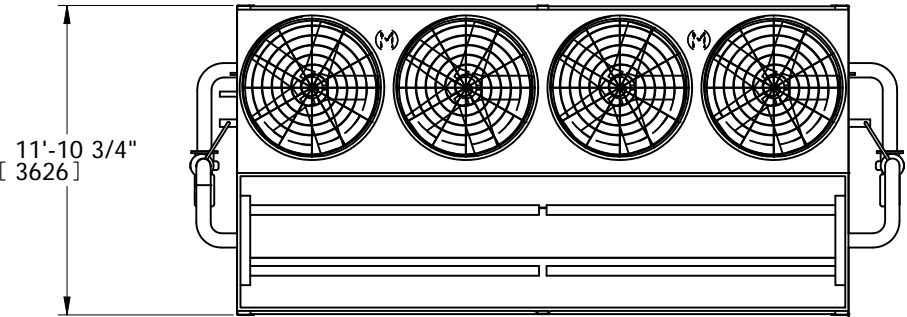

FACE 1

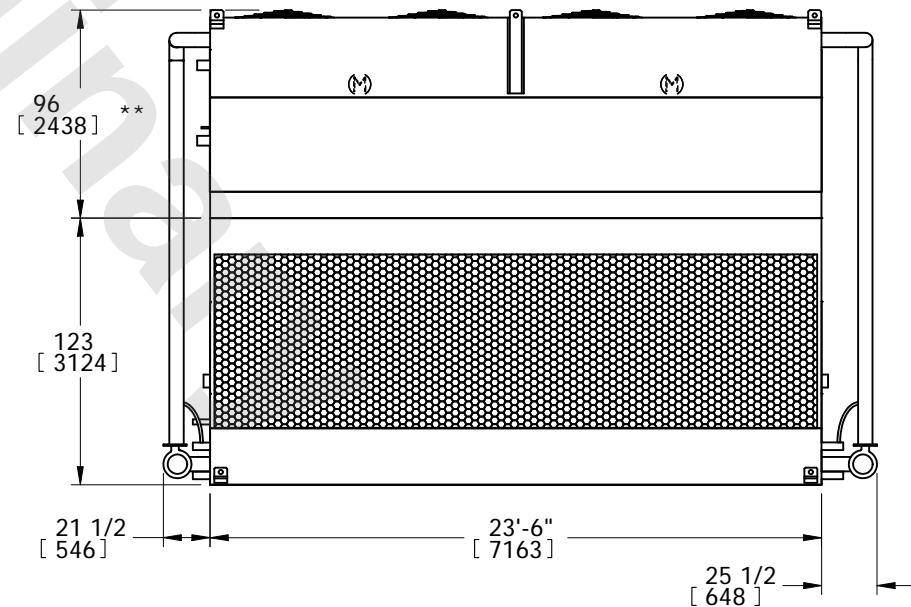
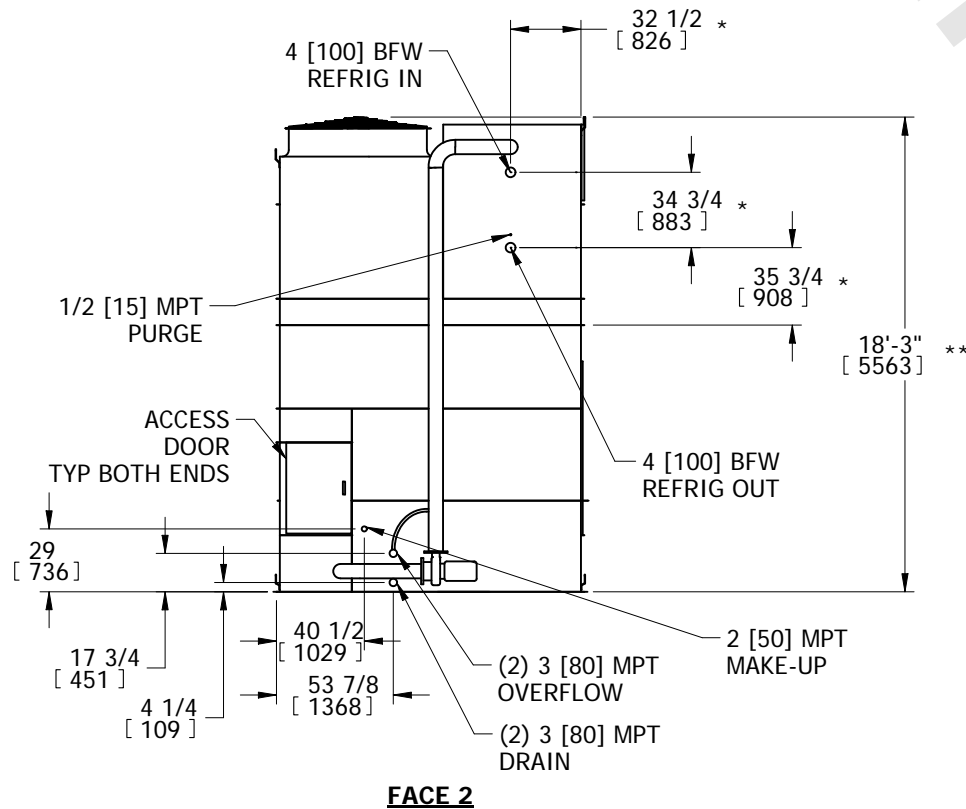

FACE 1

FACE 2

SHIPPING WEIGHT 23850 lbs+ [10820] kg+	OPERATING WEIGHT 34560 lbs+ [15680] kg+	HEAVIEST SECTION WEIGHT 15050 lbs+ [6830] kg+	NO. OF SHIPPING SECTIONS 2	DRAWN BY: TLS
-------------------------------------------	--------------------------------------------	--------------------------------------------------	-------------------------------	------------------