

|         |               |           |
|---------|---------------|-----------|
| UNIT    | COOLING TOWER |           |
| MODEL # | AT 314-2M72   | SCALE NTS |

# EVAPCO, INC.

|          |                 |      |           |
|----------|-----------------|------|-----------|
| DWG. #   | T4147224-DRA-ST | REV. | -         |
| SERIAL # |                 | DATE | 3/18/2025 |

- NOTES:
- (M)- FAN MOTOR LOCATION
  - HEAVIEST SECTION IS UPPER SECTION
  - MPT DENOTES MALE PIPE THREAD  
FPT DENOTES FEMALE PIPE THREAD  
BFW DENOTES BEVELED FOR WELDING  
GVD DENOTES GROOVED  
FLG DENOTES FLANGE  
PE DENOTES PLAIN END
  - +UNIT WEIGHT DOES NOT INCLUDE ACCESSORIES (SEE ACCESSORY DRAWINGS)
  - MAKE-UP WATER PRESSURE  
20 psi MIN [137 kPa], 50 psi MAX [344 kPa]
  - 3/4" [19MM] DIA. MOUNTING HOLES.  
REFER TO RECOMMENDED STEEL SUPPORT DRAWING
  - DIMENSIONS LISTED AS FOLLOWS:  
ENGLISH FT-IN  
[METRIC] [mm]

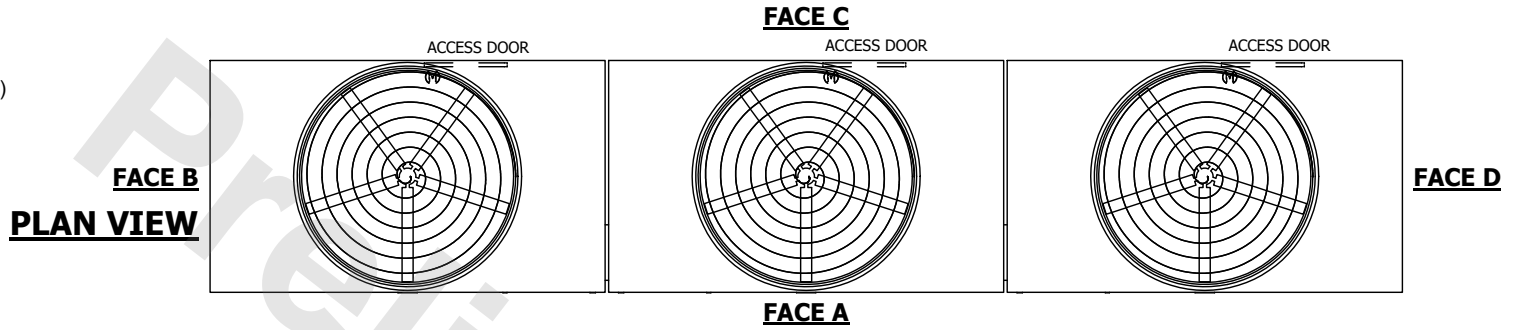

|                 |                        |                  |                        |                         |                       |                          |   |           |     |
|-----------------|------------------------|------------------|------------------------|-------------------------|-----------------------|--------------------------|---|-----------|-----|
| SHIPPING WEIGHT | 53550 lbs+ [24290] kg+ | OPERATING WEIGHT | 97740 lbs+ [44335] kg+ | HEAVIEST SECTION WEIGHT | 10670 lbs+ [4840] kg+ | NO. OF SHIPPING SECTIONS | 6 | DRAWN BY: | MER |
|-----------------|------------------------|------------------|------------------------|-------------------------|-----------------------|--------------------------|---|-----------|-----|