

UNIT	COOLING TOWER	
MODEL #	AT 26-2G17	SCALE NTS

EVAPCO, INC.

DWG. #	T3061724-DRD-ST	REV.	-
SERIAL #		DATE	3/12/2025

- NOTES:
- (M)- FAN MOTOR LOCATION
 - HEAVIEST SECTION IS UPPER SECTION
 - MPT DENOTES MALE PIPE THREAD
FPT DENOTES FEMALE PIPE THREAD
BFW DENOTES BEVELED FOR WELDING
GVD DENOTES GROOVED
FLG DENOTES FLANGE
 - +UNIT WEIGHT DOES NOT INCLUDE ACCESSORIES (SEE ACCESSORY DRAWINGS)
 - MAKE-UP WATER PRESSURE
20 psi MIN [137 kPa], 50 psi MAX [344 kPa]
 - 3/4" [19MM] DIA. MOUNTING HOLES.
REFER TO RECOMMENDED STEEL SUPPORT DRAWING
 - DIMENSIONS LISTED AS FOLLOWS:
ENGLISH FT-IN
[METRIC] [mm]

FACE B
PLAN VIEW

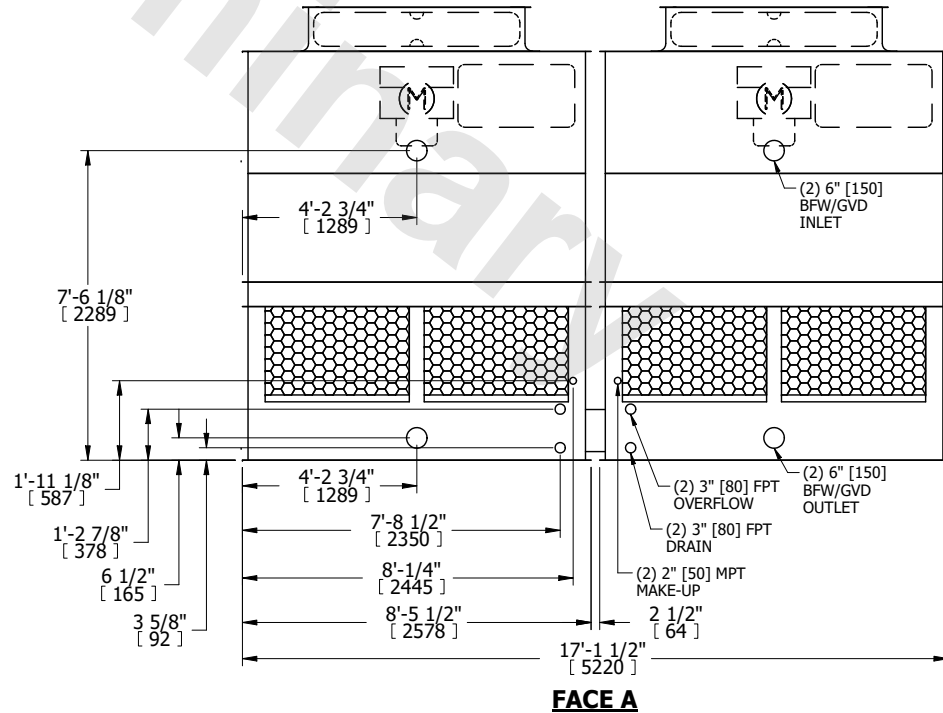
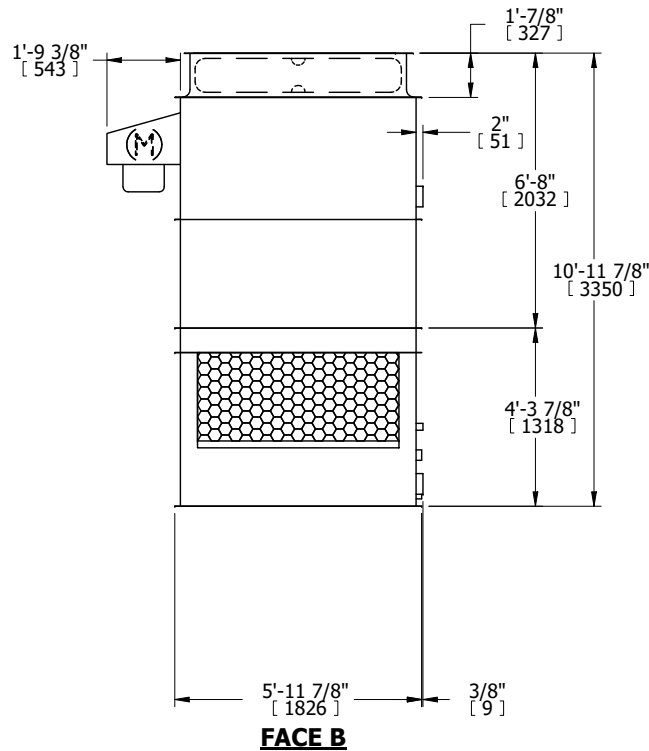

SHIPPING WEIGHT	6320 lbs+ [2870] kg+	OPERATING WEIGHT	10400 lbs+ [4720] kg+	HEAVIEST SECTION WEIGHT	2010 lbs+ [915] kg+	NO. OF SHIPPING SECTIONS	4	DRAWN BY:	JLG
-----------------	----------------------	------------------	-----------------------	-------------------------	---------------------	--------------------------	---	-----------	-----