

UNIT	COOLING TOWER	
MODEL #	AT 19-2F8	SCALE NTS



DWG. #	T3090824-DRD-ST	REV.	-
SERIAL #		DATE	3/19/2025

NOTES:

1. (M)- FAN MOTOR LOCATION
2. HEAVIEST SECTION IS UPPER SECTION
3. MPT DENOTES MALE PIPE THREAD
FPT DENOTES FEMALE PIPE THREAD
BFW DENOTES BEVELED FOR WELDING
GVD DENOTES GROOVED
FLG DENOTES FLANGE
4. +UNIT WEIGHT DOES NOT INCLUDE ACCESSORIES (SEE ACCESSORY DRAWINGS)
5. MAKE-UP WATER PRESSURE
20 psi MIN [137 kPa], 50 psi MAX [344 kPa]
6. 3/4" [19MM] DIA. MOUNTING HOLES. REFER TO RECOMENDED STEEL SUPPORT DRAWING.
7. DIMENSIONS LISTED AS FOLLOWS:
ENGLISH FT-IN
[METRIC] [mm]

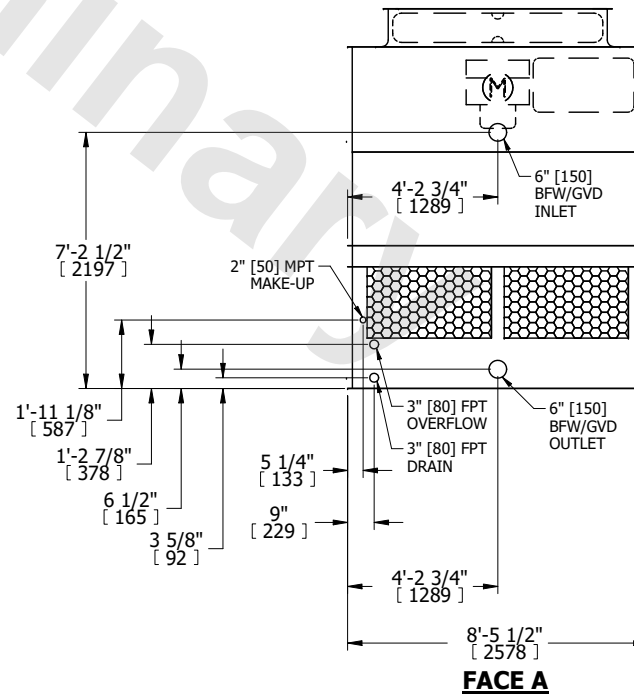
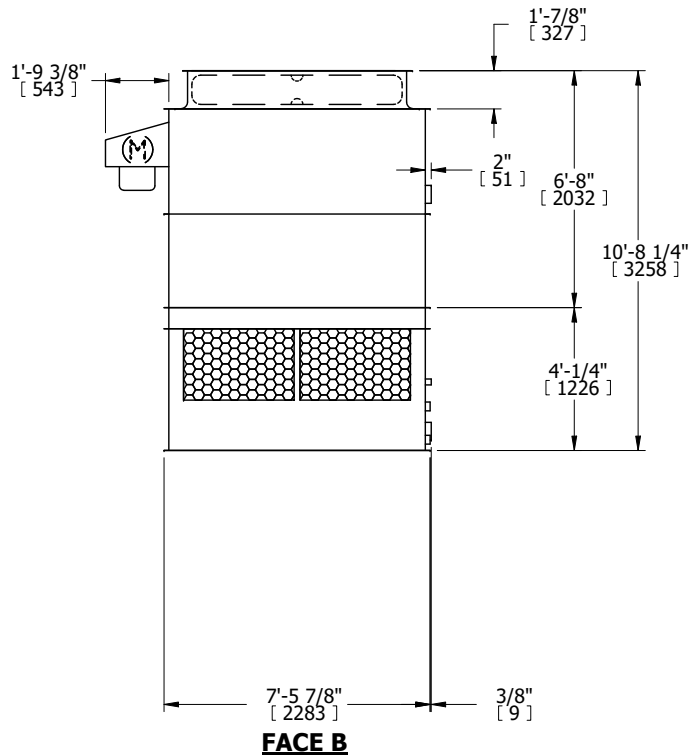
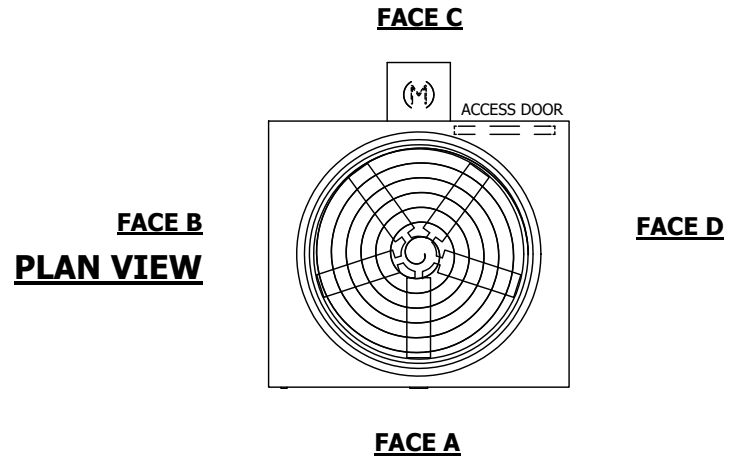

SHIPPING WEIGHT	3490 lbs+ [1585] kg+	OPERATING WEIGHT	5910 lbs+ [2685] kg+	HEAVIEST SECTION WEIGHT	2220 lbs+ [1010] kg+	NO. OF SHIPPING SECTIONS	2	DRAWN BY:	JLG
-----------------	----------------------	------------------	----------------------	-------------------------	----------------------	--------------------------	---	-----------	-----