

UNIT	COOLING TOWER	
MODEL #	AT 212-3M36	SCALE NTS



DWG. #	T3122C36-DRD-ST	REV.	-
SERIAL #		DATE	3/15/2025

- NOTES:
1. (M)- FAN MOTOR LOCATION
 2. HEAVIEST SECTION IS UPPER SECTION
 3. MPT DENOTES MALE PIPE THREAD
FPT DENOTES FEMALE PIPE THREAD
BFW DENOTES BEVELED FOR WELDING
GVD DENOTES GROOVED
FLG DENOTES FLANGE
 4. +UNIT WEIGHT DOES NOT INCLUDE ACCESSORIES (SEE ACCESSORY DRAWINGS)
 5. MAKE-UP WATER PRESSURE
20 psi MIN [137 kPa], 50 psi MAX [344 kPa]
 6. 3/4" [19MM] DIA. MOUNTING HOLES.
REFER TO RECOMMENDED STEEL SUPPORT DRAWING
 7. DIMENSIONS LISTED AS FOLLOWS:
ENGLISH FT-IN
[METRIC] [mm]

FACE B
PLAN VIEW



FACE A

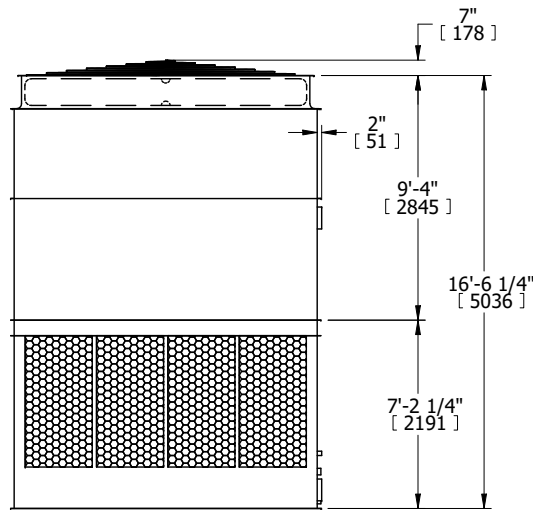

FACE B

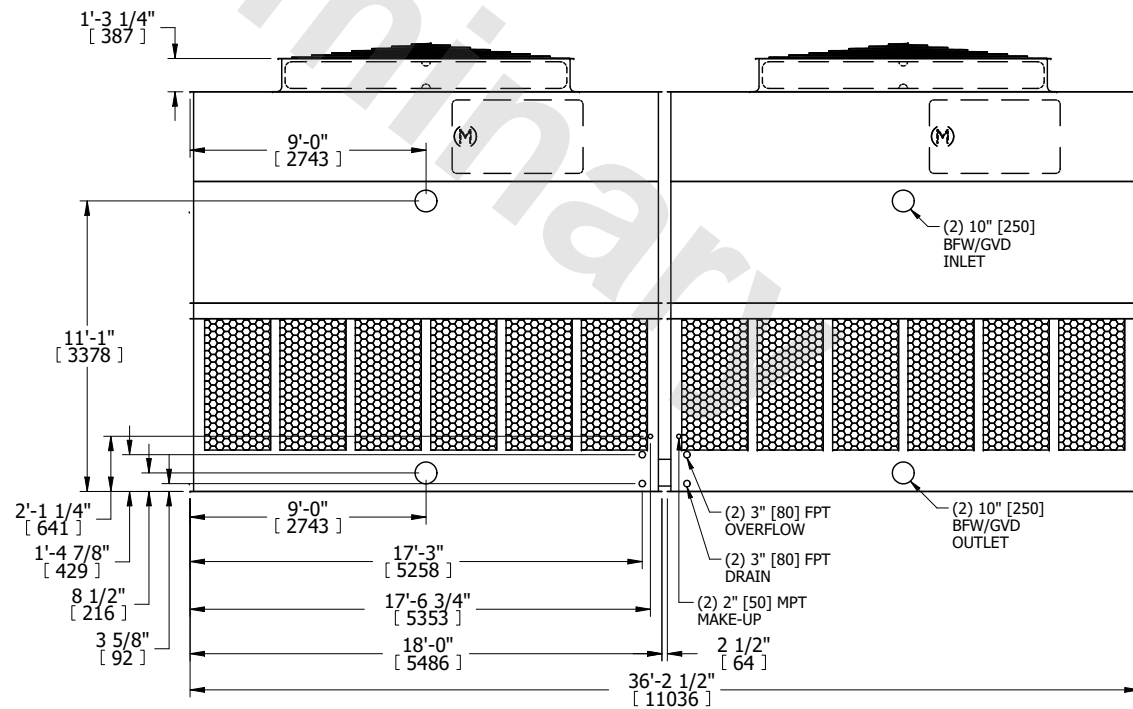

FACE A

SHIPPING WEIGHT	23460 lbs+ [10645] kg+	OPERATING WEIGHT	42000 lbs+ [19055] kg+	HEAVIEST SECTION WEIGHT	7700 lbs+ [3495] kg+	NO. OF SHIPPING SECTIONS	4	DRAWN BY:	KDS
-----------------	------------------------	------------------	------------------------	-------------------------	----------------------	--------------------------	---	-----------	-----