

UNIT	COOLING TOWER	
MODEL #	AT 424-2K28	SCALE NTS

# EVAPCO, INC.

DWG. #	T3242824-DRH-ST	REV.	-
SERIAL #		DATE	3/4/2025

- NOTES:
- (M)- FAN MOTOR LOCATION
  - HEAVIEST SECTION IS UPPER SECTION
  - MPT DENOTES MALE PIPE THREAD  
FPT DENOTES FEMALE PIPE THREAD  
BFW DENOTES BEVELED FOR WELDING  
GVD DENOTES GROOVED  
FLG DENOTES FLANGE
  - +UNIT WEIGHT DOES NOT INCLUDE ACCESSORIES (SEE ACCESSORY DRAWINGS)
  - MAKE-UP WATER PRESSURE  
20 psi MIN [137 kPa], 50 psi MAX [344 kPa]
  - 3/4" [19MM] DIA. MOUNTING HOLES. REFER TO RECOMMENDED STEEL SUPPORT DRAWING.
  - DIMENSIONS LISTED AS FOLLOWS:  
ENGLISH FT-IN  
[METRIC] [mm]

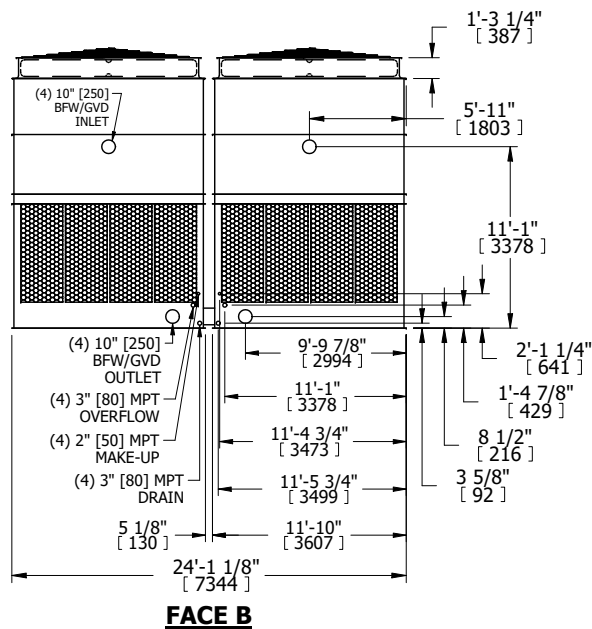

SHIPPING WEIGHT	35060 lbs+ [15905] kg+	OPERATING WEIGHT	63960 lbs+ [29015] kg+	HEAVIEST SECTION WEIGHT	6550 lbs+ [2975] kg+	NO. OF SHIPPING SECTIONS	6	DRAWN BY:	JLG
-----------------	------------------------	------------------	------------------------	-------------------------	----------------------	--------------------------	---	-----------	-----