

# EVAPCO, INC.



UNIT <b>COOLING TOWER</b>	MODEL # AT 420-3N36	SCALE N.T.S.	DWG. # T36M3636-DRE-ST	REV. -	DATE 3/6/2025	SERIAL #
------------------------------	------------------------	-----------------	---------------------------	-----------	------------------	----------

- NOTES:
- (M)- FAN MOTOR LOCATION
  - HEAVIEST SECTION IS UPPER SECTION
  - MPT DENOTES MALE PIPE THREAD  
FPT DENOTES FEMALE PIPE THREAD  
BFW DENOTES BEVELED FOR WELDING
  - +UNIT WEIGHT DOES NOT INCLUDE ACCESSORIES (SEE ACCESSORY DRAWINGS)
  - MAKE-UP WATER PRESSURE  
20 psi MIN [137 kPa], 50 psi MAX [344 kPa]

**FACE 2  
PLAN VIEW**



**FACE 1**



**FACE 2**

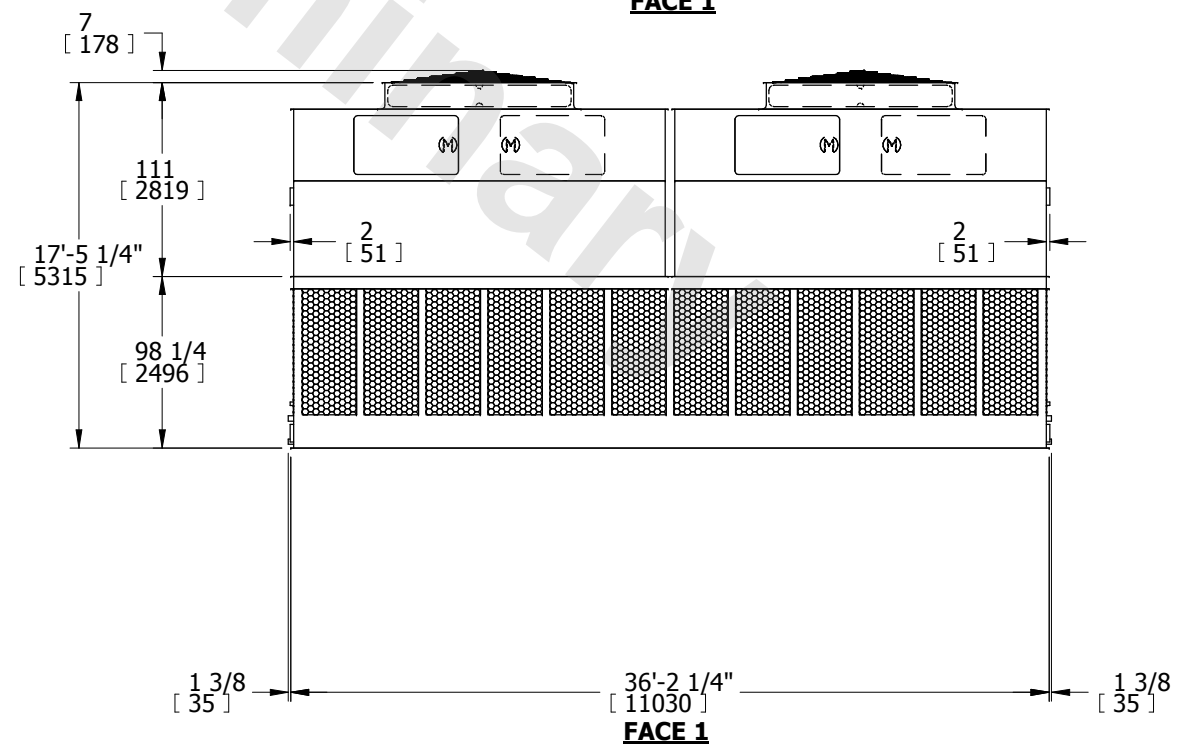

**FACE 1**

SHIPPING WEIGHT 40140 lbs+ [18207] kg+	OPERATING WEIGHT 74100 lbs+ [33611] kg+	HEAVIEST SECTION WEIGHT 6850 lbs+ [3107] kg+	NO. OF SHIPPING SECTIONS 6
---	--	---	-------------------------------