

UNIT	COOLING TOWER	
MODEL #	AT 28-3J17	SCALE NTS

EVAPCO, INC.



DWG. #	T3071736-DRD-ST	REV.	-
SERIAL #		DATE	3/19/2025

- NOTES:
- (M)- FAN MOTOR LOCATION
 - HEAVIEST SECTION IS UPPER SECTION
 - MPT DENOTES MALE PIPE THREAD
FPT DENOTES FEMALE PIPE THREAD
BFW DENOTES BEVELED FOR WELDING
GVD DENOTES GROOVED
FLG DENOTES FLANGE
 - +UNIT WEIGHT DOES NOT INCLUDE ACCESSORIES (SEE ACCESSORY DRAWINGS)
 - MAKE-UP WATER PRESSURE
20 psi MIN [137 kPa], 50 psi MAX [344 kPa]
 - 3/4" [19MM] DIA. MOUNTING HOLES. REFER TO RECOMMENDED STEEL SUPPORT DRAWING.
 - DIMENSIONS LISTED AS FOLLOWS:
ENGLISH FT-IN
[METRIC] [mm]

**FACE B
PLAN VIEW**



FACE D

FACE A



FACE B

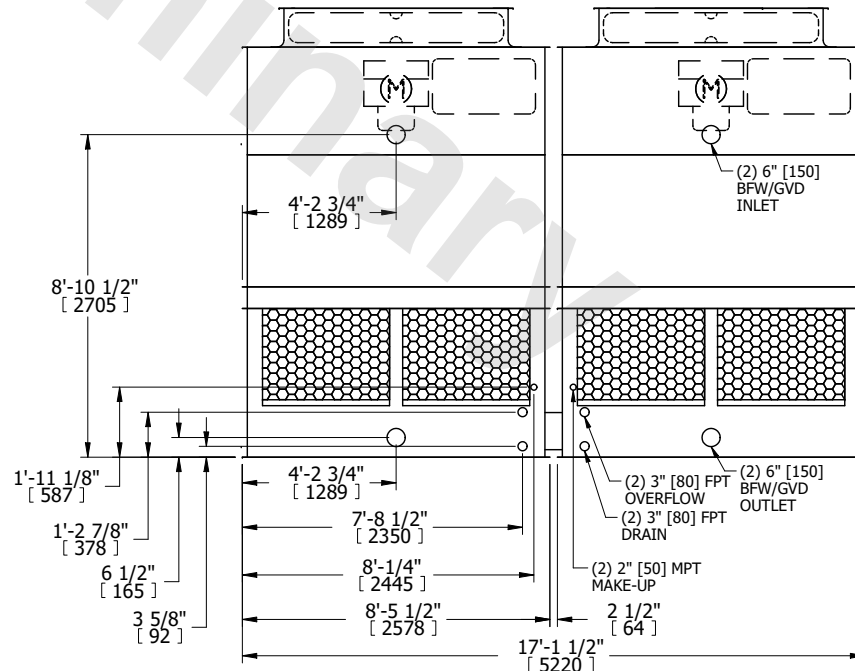

FACE A

SHIPPING WEIGHT	7900 lbs+ [3585] kg+	OPERATING WEIGHT	12740 lbs+ [5780] kg+	HEAVIEST SECTION WEIGHT	2640 lbs+ [1200] kg+	NO. OF SHIPPING SECTIONS	4	DRAWN BY:	JLG
-----------------	----------------------	------------------	-----------------------	-------------------------	----------------------	--------------------------	---	-----------	-----