

|         |               |           |
|---------|---------------|-----------|
| UNIT    | COOLING TOWER |           |
| MODEL # | AT 19-2J12    | SCALE NTS |



|          |                 |      |            |
|----------|-----------------|------|------------|
| DWG. #   | T3091224-DRD-ST | REV. | -          |
| SERIAL # |                 | DATE | 10/11/2024 |

- NOTES:
- (M)- FAN MOTOR LOCATION
  - HEAVIEST SECTION IS UPPER SECTION
  - MPT DENOTES MALE PIPE THREAD  
FPT DENOTES FEMALE PIPE THREAD  
BFW DENOTES BEVELED FOR WELDING  
GVD DENOTES GROOVED  
FLG DENOTES FLANGE
  - +UNIT WEIGHT DOES NOT INCLUDE ACCESSORIES (SEE ACCESSORY DRAWINGS)
  - MAKE-UP WATER PRESSURE  
20 psi MIN [137 kPa], 50 psi MAX [344 kPa]
  - 3/4" [19MM] DIA. MOUNTING HOLES. REFER TO RECOMENDED STEEL SUPPORT DRAWING.
  - DIMENSIONS LISTED AS FOLLOWS:  
ENGLISH FT-IN  
[METRIC] [mm]

**FACE B**  
**PLAN VIEW**

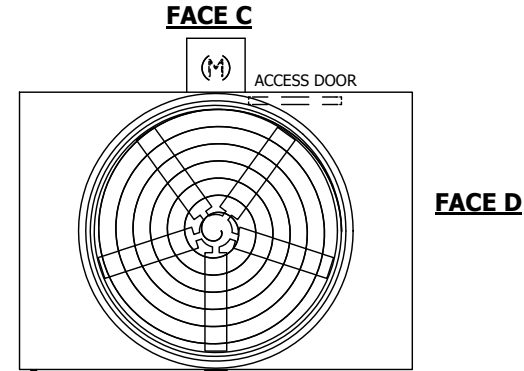

**FACE A**

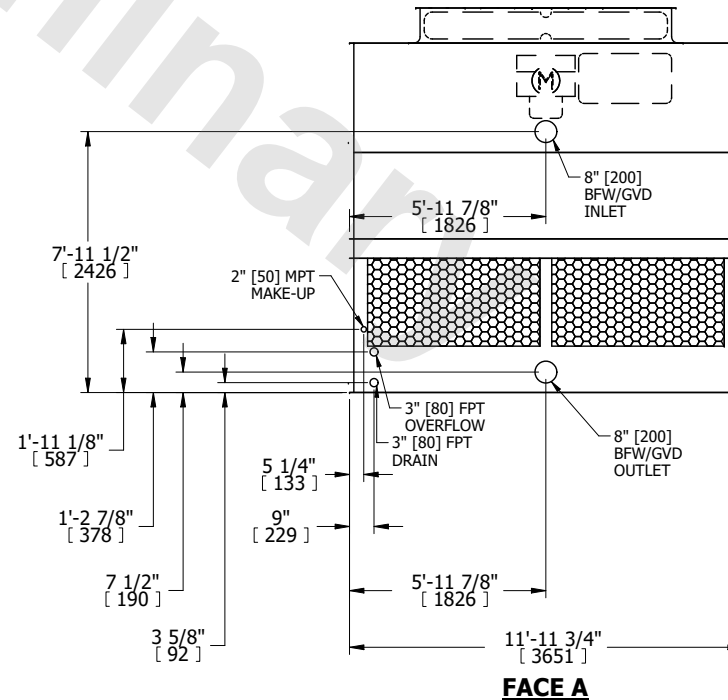
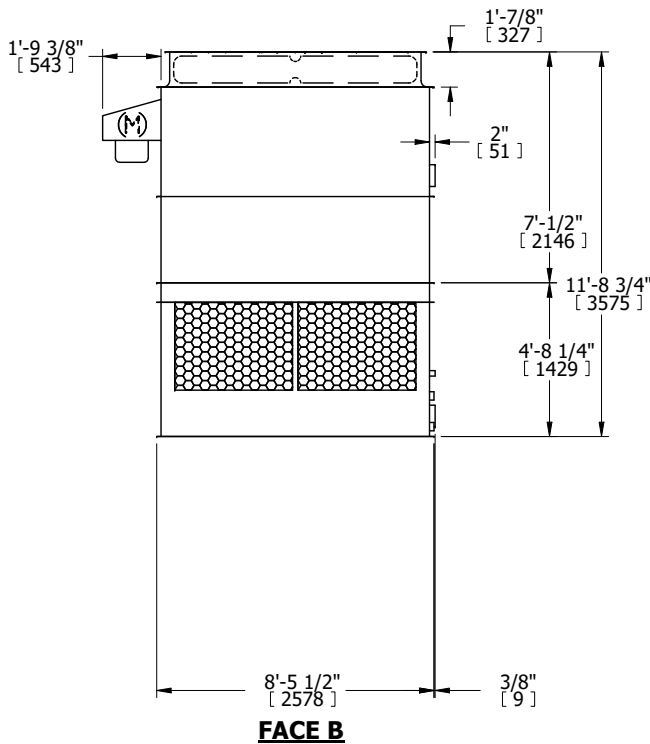

|                 |                      |                  |                      |                         |                      |                          |   |           |     |
|-----------------|----------------------|------------------|----------------------|-------------------------|----------------------|--------------------------|---|-----------|-----|
| SHIPPING WEIGHT | 5300 lbs+ [2405] kg+ | OPERATING WEIGHT | 9160 lbs+ [4155] kg+ | HEAVIEST SECTION WEIGHT | 3540 lbs+ [1610] kg+ | NO. OF SHIPPING SECTIONS | 2 | DRAWN BY: | JLG |
|-----------------|----------------------|------------------|----------------------|-------------------------|----------------------|--------------------------|---|-----------|-----|