

UNIT	COOLING TOWER	
MODEL #	AT 210-4J24	SCALE NTS

EVAPCO, INC.

DWG. #	T3TM2448-DRD-ST	REV.	-
SERIAL #		DATE	10/6/2024

- NOTES:
1. (M)- FAN MOTOR LOCATION
 2. HEAVIEST SECTION IS UPPER SECTION
 3. MPT DENOTES MALE PIPE THREAD
FPT DENOTES FEMALE PIPE THREAD
BFW DENOTES BEVELED FOR WELDING
GVD DENOTES GROOVED
FLG DENOTES FLANGE
 4. +UNIT WEIGHT DOES NOT INCLUDE ACCESSORIES (SEE ACCESSORY DRAWINGS)
 5. MAKE-UP WATER PRESSURE
20 psi MIN [137 kPa], 50 psi MAX [344 kPa]
 6. 3/4" [19MM] DIA. MOUNTING HOLES. REFER TO RECOMMENDED STEEL SUPPORT DRAWING.
 7. DIMENSIONS LISTED AS FOLLOWS:
ENGLISH FT-IN
[METRIC] [mm]

FACE B
PLAN VIEW

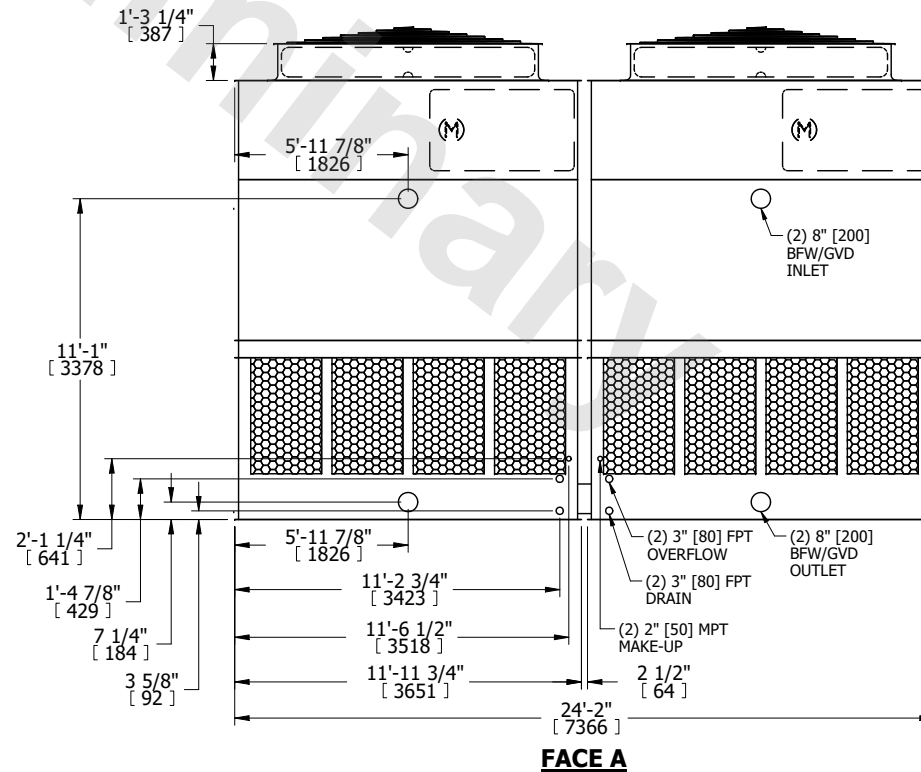
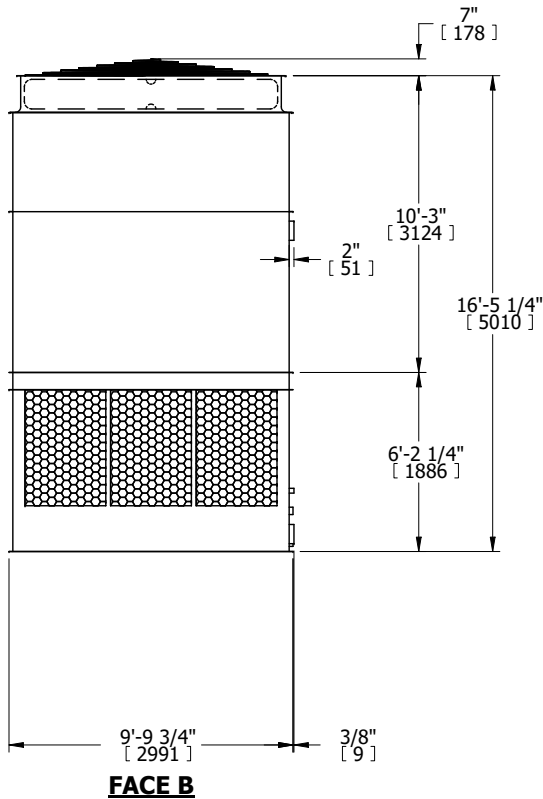
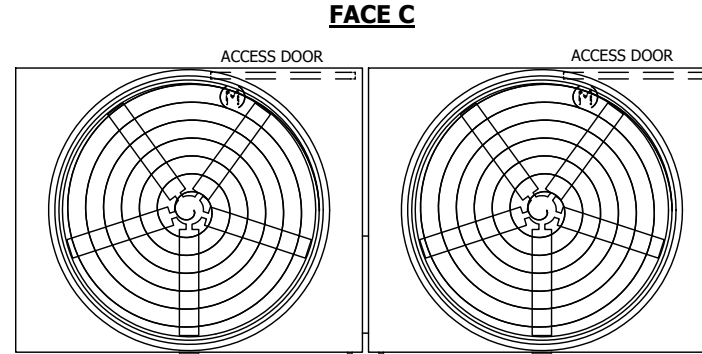

SHIPPING WEIGHT	15220 lbs+ [6905] kg+	OPERATING WEIGHT	25140 lbs+ [11405] kg+	HEAVIEST SECTION WEIGHT	5170 lbs+ [2350] kg+	NO. OF SHIPPING SECTIONS	4	DRAWN BY:	JLG
-----------------	-----------------------	------------------	------------------------	-------------------------	----------------------	--------------------------	---	-----------	-----