

UNIT	COOLING TOWER	
MODEL #	AT 114-4L18	SCALE NTS

# EVAPCO, INC.

DWG. #	T4141848-DRA-ST	REV	-
SERIAL #		DATE:	3/6/2025

- NOTES:
- (M)- FAN MOTOR LOCATION
  - HEAVIEST SECTION IS FAN/CASING SECTION
  - MPT DENOTES MALE PIPE THREAD  
FPT DENOTES FEMALE PIPE THREAD  
BFW DENOTES BEVELED FOR WELDING  
GVD DENOTES GROOVED  
FLG DENOTES FLANGE
  - +UNIT WEIGHT DOES NOT INCLUDE ACCESSORIES (SEE ACCESSORY DRAWINGS)
  - 3/4" [19MM] DIA. MOUNTING HOLES. REFER TO RECOMMENDED STEEL SUPPORT DRAWING
  - DIMENSIONS LISTED AS FOLLOWS:  
ENGLISH FT-IN  
[METRIC] [mm]
  - MAKE-UP WATER PRESSURE  
20 psi MIN [137 kPa], 50 psi MAX [344 kPa]

**FACE B  
PLAN VIEW**



**FACE D**

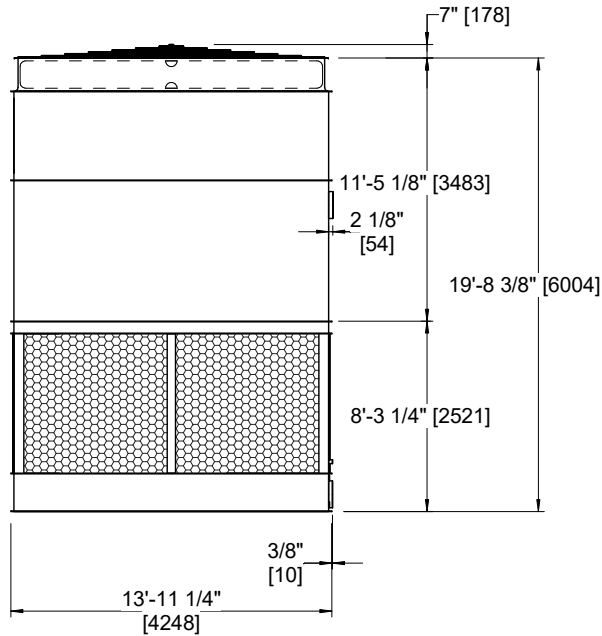

**FACE B**

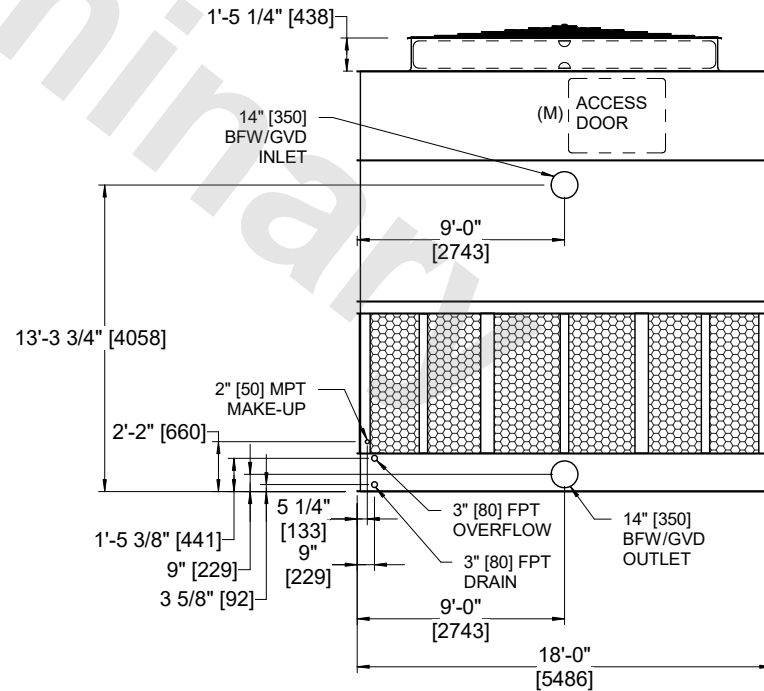

**FACE A**

SHIPPING WEIGHT	17430 lbs+ [7910] kg+	OPERATING WEIGHT	27140 lbs+ [12315] kg+	HEAVIEST SECTION WEIGHT	12200 lbs+ [5535] kg+	NO. OF SHIPPING SECTIONS	2	DRAWN BY:	JLG
-----------------	-----------------------	------------------	------------------------	-------------------------	-----------------------	--------------------------	---	-----------	-----