

UNIT	CONDENSER	
MODEL #	PMRC-1269	SCALE NTS

EVAPCO, INC.

DWG. #	CEWR123606-DRA-ST	REV	-
SERIAL #		DATE:	10/18/2024

- NOTES:**
- (M) - FAN MOTOR LOCATION
 - HEAVIEST SECTION IS UPPER SECTION
 - MPT DENOTES MALE PIPE THREAD
FPT DENOTES FEMALE PIPE THREAD
BFW DENOTES BEVELED FOR WELDING
 - +UNIT WEIGHT DOES NOT INCLUDE ACCESSORIES (SEE ACCESSORY DRAWINGS)
 - 3/4" DIA. MOUNTING HOLES. REFER TO RECOMMENDED STEEL SUPPORT DRAWING.
 - MAKE-UP WATER PRESSURE
20 psi MIN [137 kPa], 50 psi MAX [344 kPa]
 - *- APPROXIMATE DIMENSIONS DO NOT USE FOR PRE-FABRICATION OF CONNECTING PIPING
 - DIMENSIONS LISTED AS FOLLOWS: ENGLISH IN [METRIC] [mm]

FACE B
PLAN VIEW

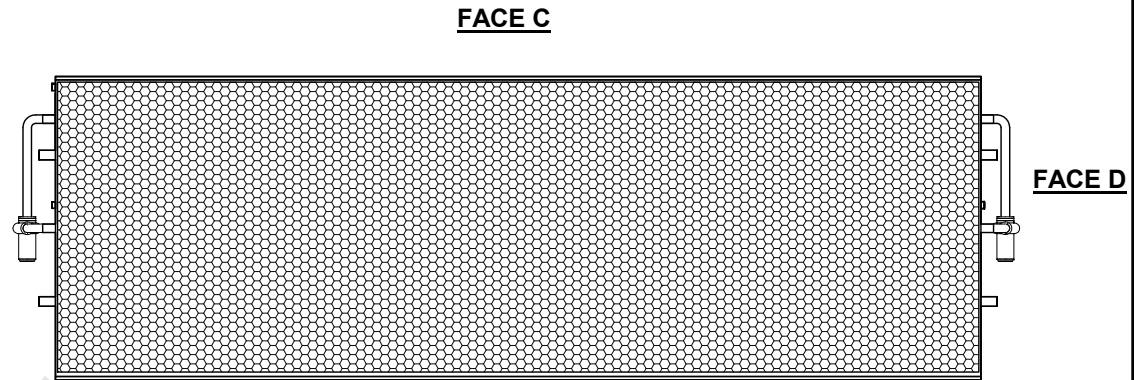

FACE A

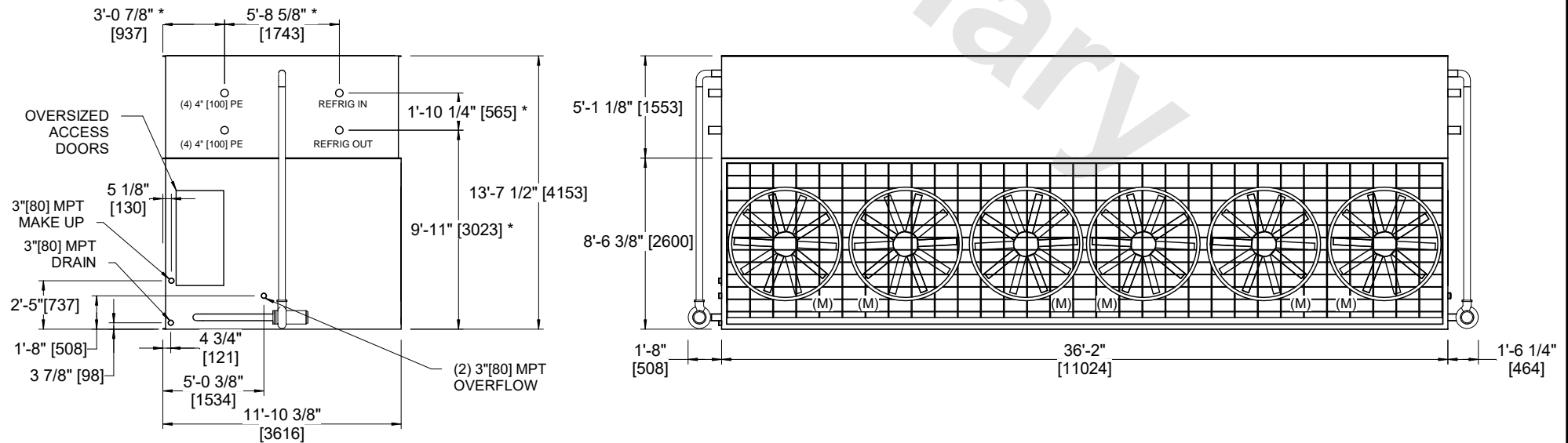

FACE B

FACE A

SHIPPING WEIGHT	44310 lbs+ [20100] kg+	OPERATING WEIGHT	58640 lbs+ [26600] kg+	HEAVIEST SECTION WEIGHT	15290 lbs+ [6940] kg+	NO. OF SHIPPING SECTIONS	3	DRAWN BY:	JLG
-----------------	------------------------	------------------	------------------------	-------------------------	-----------------------	--------------------------	---	-----------	-----