

UNIT	CONDENSER	
MODEL #	PMRC-1290	SCALE NTS

# EVAPCO, INC.

DWG. #	CEWRM3608-DRA-ST	REV	-
SERIAL #		DATE:	10/18/2024

- NOTES:**
- (M) - FAN MOTOR LOCATION
  - HEAVIEST SECTION IS UPPER SECTION
  - MPT DENOTES MALE PIPE THREAD  
FPT DENOTES FEMALE PIPE THREAD  
BFW DENOTES BEVELED FOR WELDING
  - +UNIT WEIGHT DOES NOT INCLUDE ACCESSORIES (SEE ACCESSORY DRAWINGS)
  - 3/4" DIA. MOUNTING HOLES. REFER TO RECOMMENDED STEEL SUPPORT DRAWING.
  - MAKE-UP WATER PRESSURE  
20 psi MIN [137 kPa], 50 psi MAX [344 kPa]
  - \*- APPROXIMATE DIMENSIONS DO NOT USE FOR PRE-FABRICATION OF CONNECTING PIPING
  - DIMENSIONS LISTED AS FOLLOWS: ENGLISH IN [METRIC] [mm]

**FACE B**  
**PLAN VIEW**

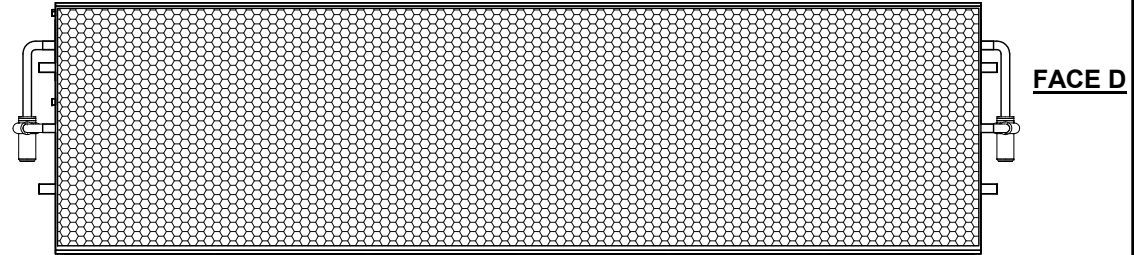

**FACE A**

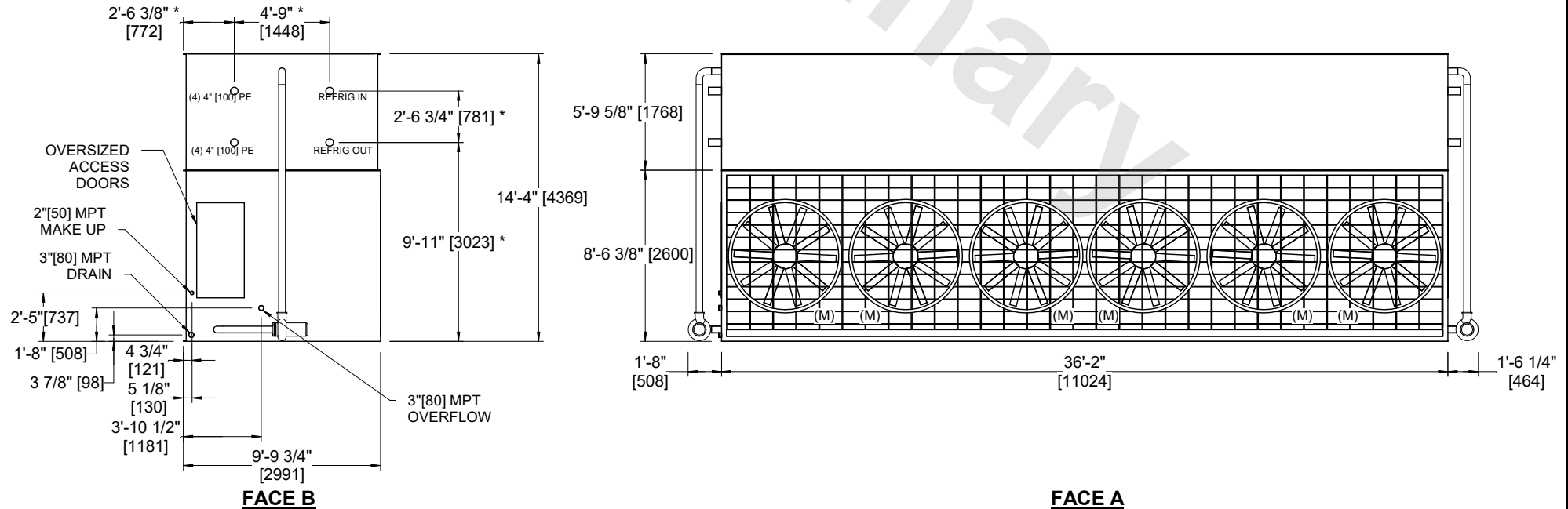

SHIPPING WEIGHT	44840 lbs+ [20340] kg+	OPERATING WEIGHT	56900 lbs+ [25810] kg+	HEAVIEST SECTION WEIGHT	15260 lbs+ [6925] kg+	NO. OF SHIPPING SECTIONS	3	DRAWN BY:	JLG
-----------------	------------------------	------------------	------------------------	-------------------------	-----------------------	--------------------------	---	-----------	-----