

UNIT	COOLING TOWER	
MODEL #	AT 312-4N36	SCALE NTS

EVAPCO, INC.

DWG. #	T3123C48-DRD-ST	REV.	-
SERIAL #		DATE	10/6/2024

- NOTES:
- (M)- FAN MOTOR LOCATION
 - HEAVIEST SECTION IS UPPER SECTION
 - MPT DENOTES MALE PIPE THREAD
FPT DENOTES FEMALE PIPE THREAD
BFW DENOTES BEVELED FOR WELDING
GVD DENOTES GROOVED
FLG DENOTES FLANGE
 - +UNIT WEIGHT DOES NOT INCLUDE ACCESSORIES (SEE ACCESSORY DRAWINGS)
 - MAKE-UP WATER PRESSURE
20 psi MIN [137 kPa], 50 psi MAX [344 kPa]
 - 3/4" [19MM] DIA. MOUNTING HOLES. REFER TO RECOMMENDED STEEL SUPPORT DRAWING.
 - DIMENSIONS LISTED AS FOLLOWS:
ENGLISH FT-IN
[METRIC] mm.

**FACE B
PLAN VIEW**



FACE A

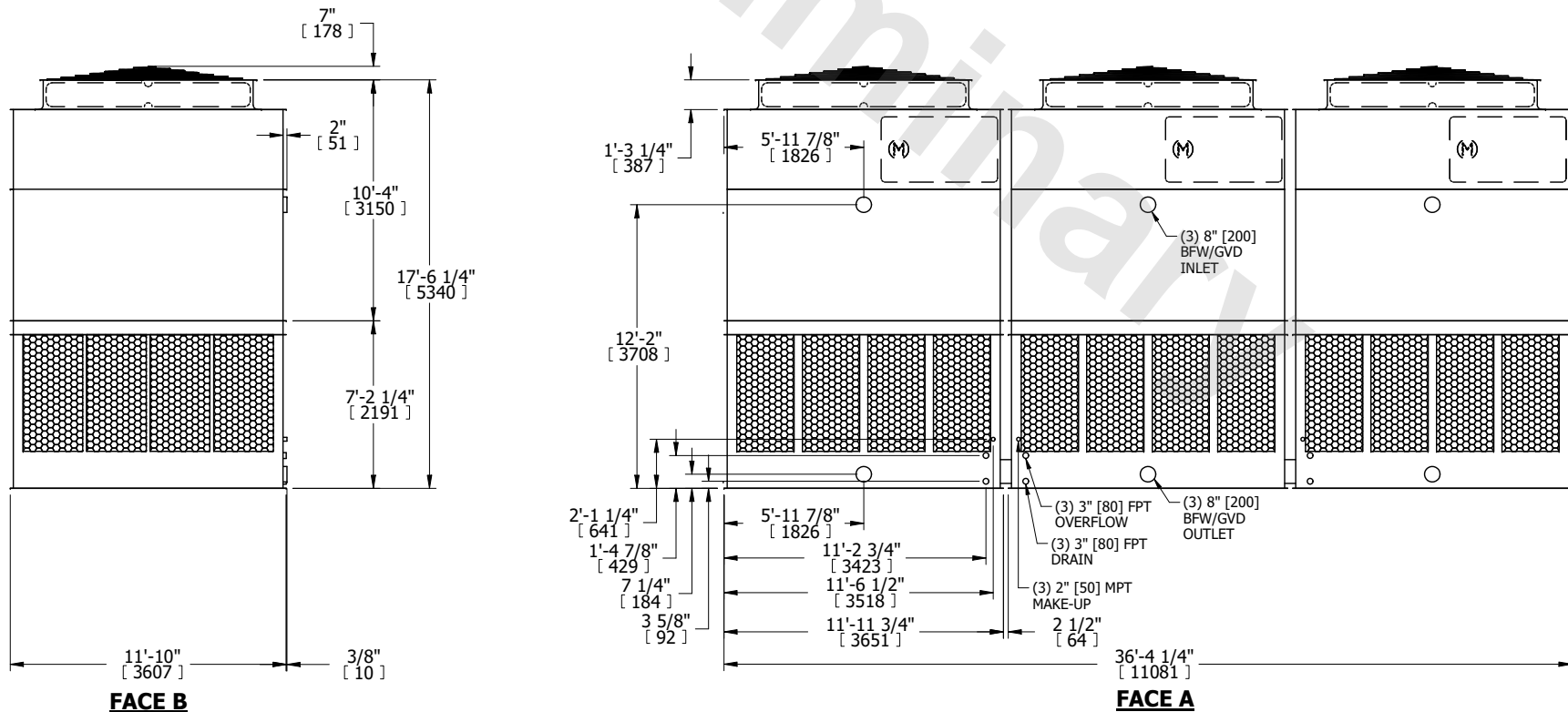

SHIPPING WEIGHT	27480 lbs+ [12465] kg+	OPERATING WEIGHT	46110 lbs+ [20920] kg+	HEAVIEST SECTION WEIGHT	6480 lbs+ [2940] kg+	NO. OF SHIPPING SECTIONS	6	DRAWN BY:	JLG
-----------------	------------------------	------------------	------------------------	-------------------------	----------------------	--------------------------	---	-----------	-----