

UNIT	COOLING TOWER	
MODEL #	AT 312-2L42	SCALE NTS



DWG. #	T3124224-DRE-ST	REV.	-
SERIAL #		DATE	10/8/2024

- NOTES:
- (M)- FAN MOTOR LOCATION
 - HEAVIEST SECTION IS UPPER SECTION
 - MPT DENOTES MALE PIPE THREAD
FPT DENOTES FEMALE PIPE THREAD
BFW DENOTES BEVELED FOR WELDING
GVD DENOTES GROOVED
FLG DENOTES FLANGE
 - +UNIT WEIGHT DOES NOT INCLUDE ACCESSORIES (SEE ACCESSORY DRAWINGS)
 - MAKE-UP WATER PRESSURE
20 psi MIN [137 kPa], 50 psi MAX [344 kPa]
 - 3/4" [19MM] DIA. MOUNTING HOLES.
REFER TO RECOMMENDED STEEL SUPPORT DRAWING
 - DIMENSIONS LISTED AS FOLLOWS:
ENGLISH FT-IN
[METRIC] [mm]

FACE B
PLAN VIEW

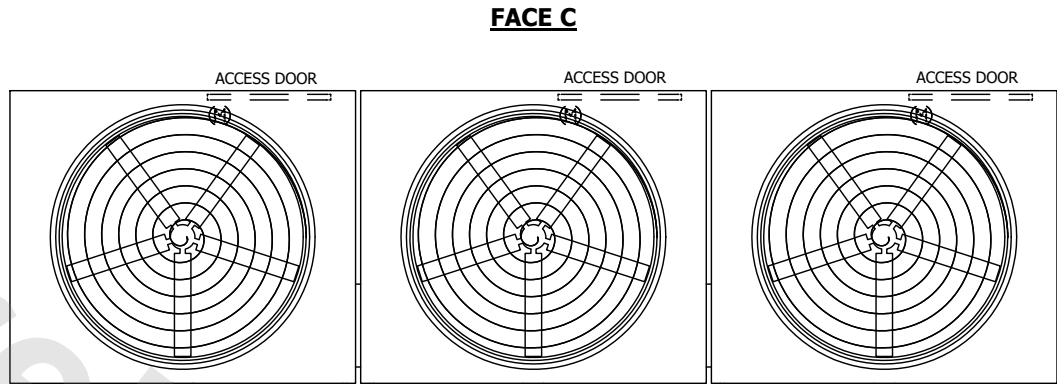

FACE A

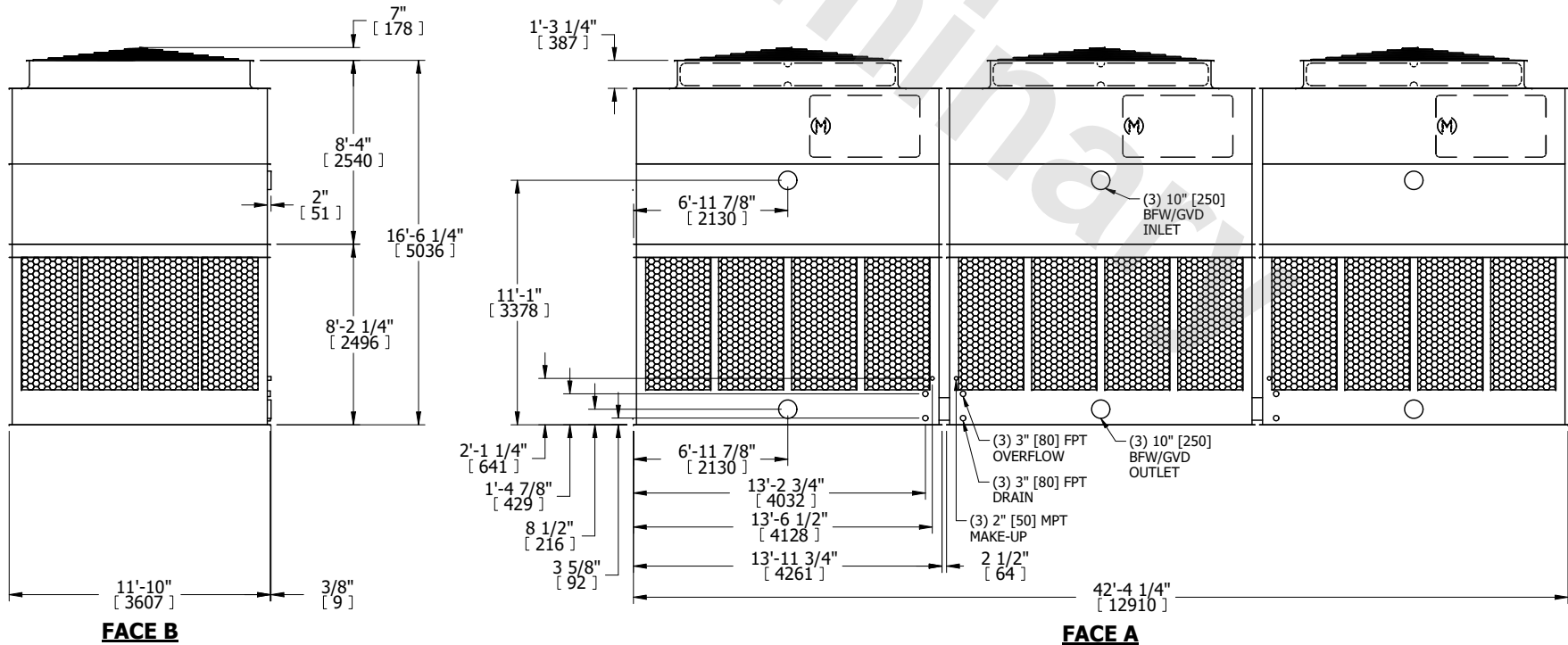

SHIPPING WEIGHT	26130 lbs+ [11855] kg+	OPERATING WEIGHT	48120 lbs+ [21830] kg+	HEAVIEST SECTION WEIGHT	5550 lbs+ [2520] kg+	NO. OF SHIPPING SECTIONS	6	DRAWN BY:	KDS
-----------------	------------------------	------------------	------------------------	-------------------------	----------------------	--------------------------	---	-----------	-----