

UNIT	COOLING TOWER	
MODEL #	AT 26-3H17	SCALE NTS

# EVAPCO, INC.

DWG. #	T3061736-DRD-ST	REV.	-
SERIAL #		DATE	3/13/2025

- NOTES:
- (M)- FAN MOTOR LOCATION
  - HEAVIEST SECTION IS UPPER SECTION
  - MPT DENOTES MALE PIPE THREAD  
FPT DENOTES FEMALE PIPE THREAD  
BFW DENOTES BEVELED FOR WELDING  
GVD DENOTES GROOVED  
FLG DENOTES FLANGE
  - +UNIT WEIGHT DOES NOT INCLUDE ACCESSORIES (SEE ACCESSORY DRAWINGS)
  - MAKE-UP WATER PRESSURE  
20 psi MIN [137 kPa], 50 psi MAX [344 kPa]
  - 3/4" [19MM] DIA. MOUNTING HOLES.  
REFER TO RECOMMENDED STEEL SUPPORT DRAWING
  - DIMENSIONS LISTED AS FOLLOWS:  
ENGLISH FT-IN  
[METRIC] [mm]

**FACE B**  
**PLAN VIEW**

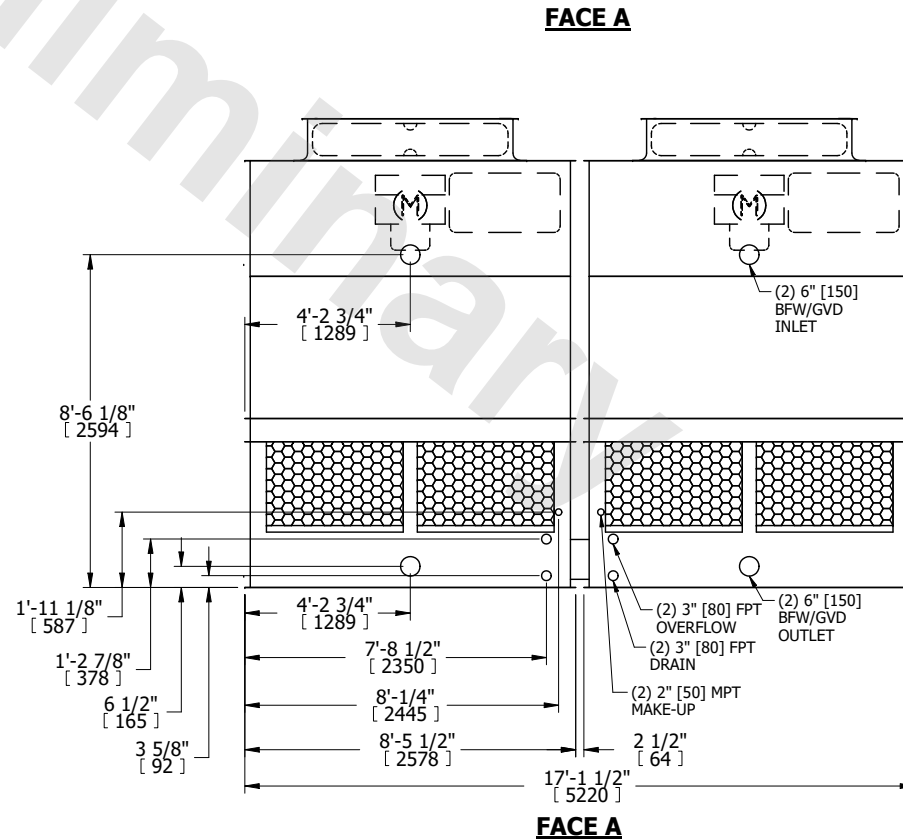
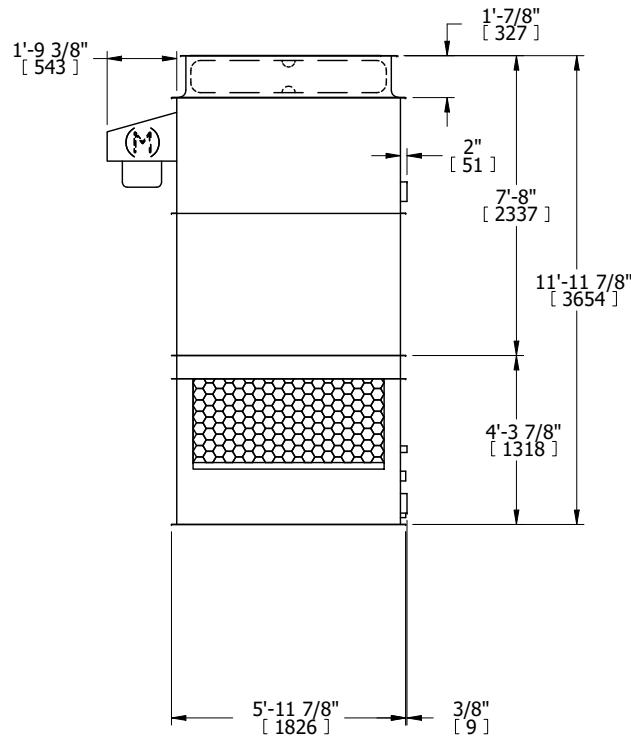
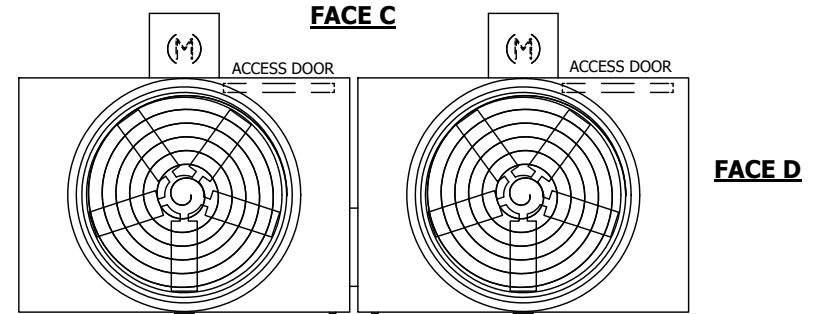

SHIPPING WEIGHT	6800 lbs+ [3085] kg+	OPERATING WEIGHT	10880 lbs+ [4940] kg+	HEAVIEST SECTION WEIGHT	2250 lbs+ [1025] kg+	NO. OF SHIPPING SECTIONS	4	DRAWN BY:	JLG
-----------------	----------------------	------------------	-----------------------	-------------------------	----------------------	--------------------------	---	-----------	-----