

UNIT	COOLING TOWER	
MODEL #	AT 428-5N52	SCALE NTS

# EVAPCO, INC.

DWG. #	T4285260-DRA-ST	REV.	-
SERIAL #		DATE	9/20/2024

- NOTES:
- (M)- FAN MOTOR LOCATION
  - HEAVIEST SECTION IS UPPER SECTION
  - MPT DENOTES MALE PIPE THREAD  
FPT DENOTES FEMALE PIPE THREAD  
BFW DENOTES BEVELED FOR WELDING  
GVD DENOTES GROOVED  
FLG DENOTES FLANGE  
PE DENOTES PLAIN END
  - +UNIT WEIGHT DOES NOT INCLUDE ACCESSORIES (SEE ACCESSORY DRAWINGS)
  - MAKE-UP WATER PRESSURE  
20 psi MIN [137 kPa], 50 psi MAX [344 kPa]
  - 3/4" [19MM] DIA. MOUNTING HOLES.  
REFER TO RECOMMENDED STEEL SUPPORT DRAWING
  - DIMENSIONS LISTED AS FOLLOWS:  
ENGLISH FT-IN  
[METRIC] [mm]
  - PAN FLUME BOX EQUALIZERS SUPPLIED BY EVAPCO. PAN EQUALIZER PIPING IS SUPPLIED BY OTHERS.
  - PAN EQUALIZER NIPPLE IS 11'-10 3/8" [3616]  
OFF EACH STEP SIDE.

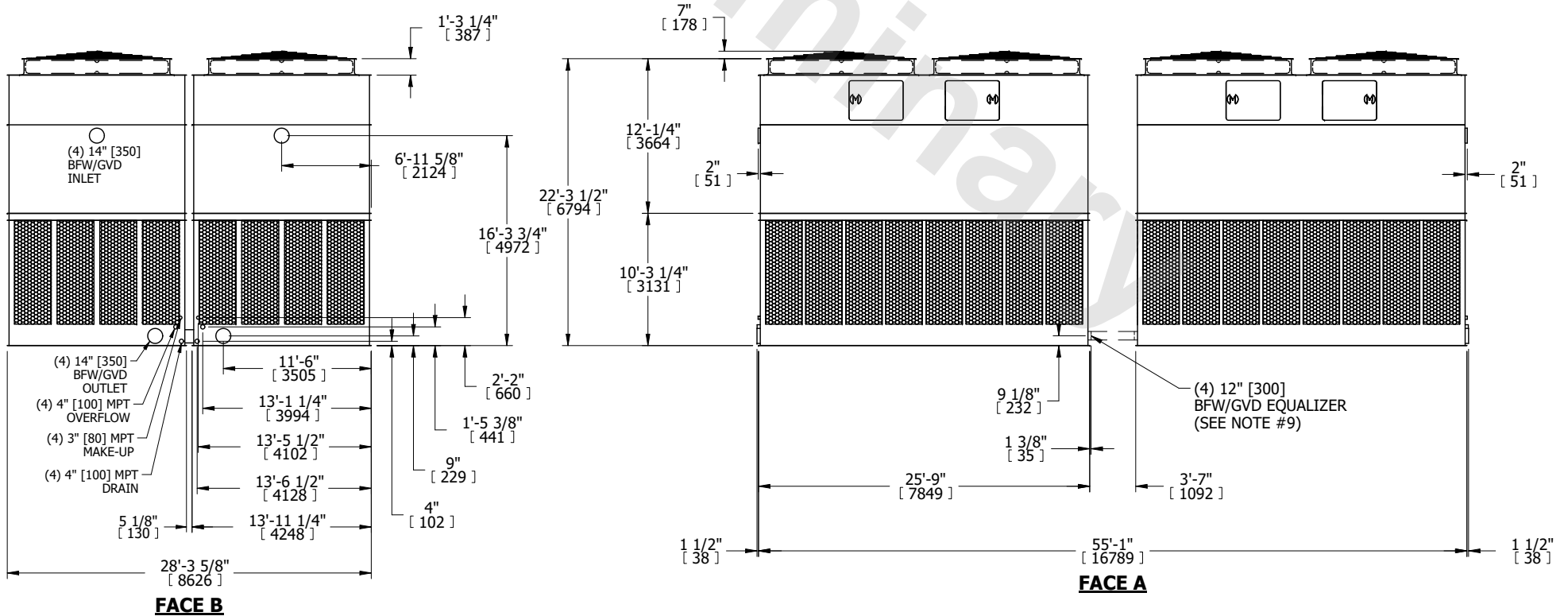
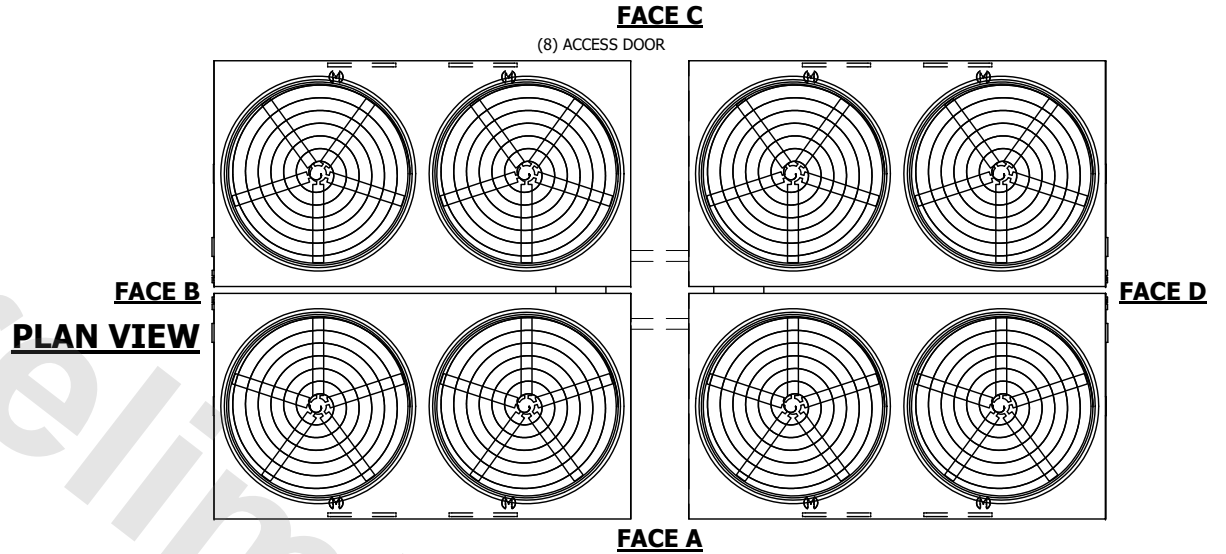

SHIPPING WEIGHT	99880 lbs+ [45305] kg+	OPERATING WEIGHT	166440 lbs+ [75500] kg+	HEAVIEST SECTION WEIGHT	18140 lbs+ [8230] kg+	NO. OF SHIPPING SECTIONS	8	DRAWN BY:	MER
-----------------	------------------------	------------------	-------------------------	-------------------------	-----------------------	--------------------------	---	-----------	-----