

UNIT	COOLING TOWER	
MODEL #	AT 27-2K28	SCALE NTS

EVAPCO, INC.



DWG. #	CT4C072824-DRA-ST	REV	-
SERIAL #		DATE:	3/15/2025

NOTES:

- (M)- FAN MOTOR LOCATION
- HEAVIEST SECTION IS FAN/CASING SECTION
- MPT DENOTES MALE PIPE THREAD
FPT DENOTES FEMALE PIPE THREAD
BFW DENOTES BEVELED FOR WELDING
GVD DENOTES GROOVED
FLG DENOTES FLANGE
- +UNIT WEIGHT DOES NOT INCLUDE ACCESSORIES (SEE ACCESSORY DRAWINGS)
- 3/4" [19MM] DIA. MOUNTING HOLES. REFER TO RECOMMENDED STEEL SUPPORT DRAWING
- DIMENSIONS LISTED AS FOLLOWS:
ENGLISH FT-IN
[METRIC] [mm]
- MAKE-UP WATER PRESSURE
20 psi MIN [137 kPa], 50 psi MAX [344 kPa]

FACE C

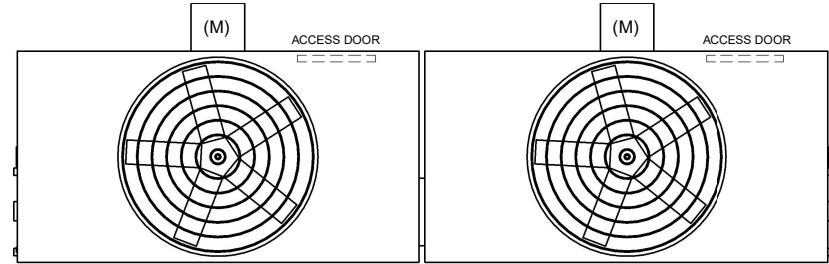

FACE D

**FACE B
PLAN VIEW**

FACE A

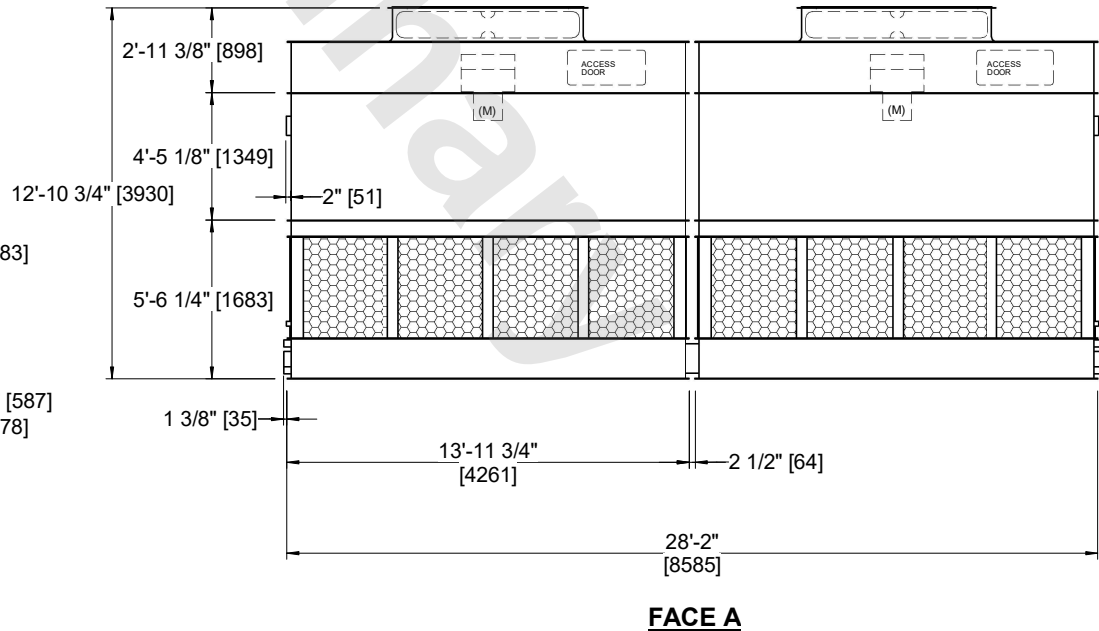
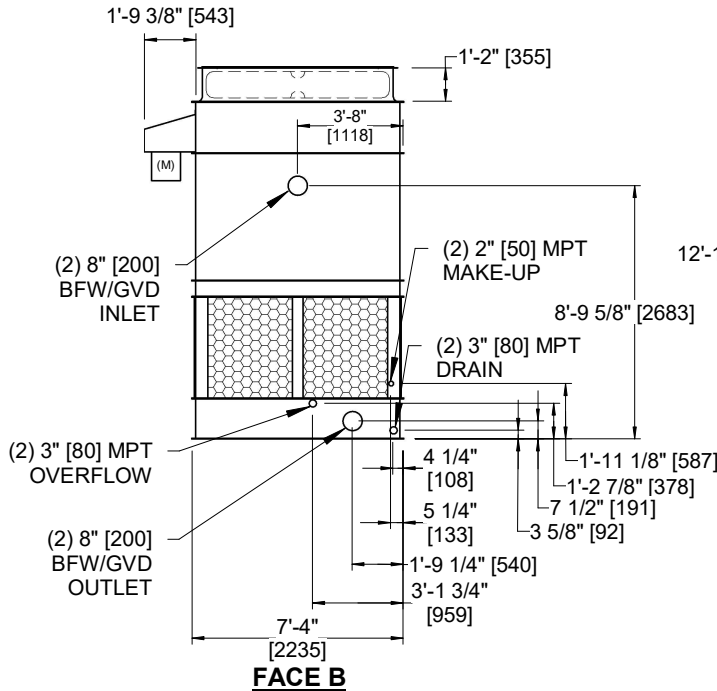

SHIPPING WEIGHT	11060 lbs+ [5020] kg+	OPERATING WEIGHT	18910 lbs+ [8580] kg+	HEAVIEST SECTION WEIGHT	3530 lbs+ [1605] kg+	NO. OF SHIPPING SECTIONS	4	DRAWN BY:	JLG
-----------------	-----------------------	------------------	-----------------------	-------------------------	----------------------	--------------------------	---	-----------	-----