

| | | |
|---------|------------------------------|-----------|
| UNIT | CLOSED CIRCUIT COOLER | |
| MODEL # | LRWB 5-5J9-Z | SCALE NTS |

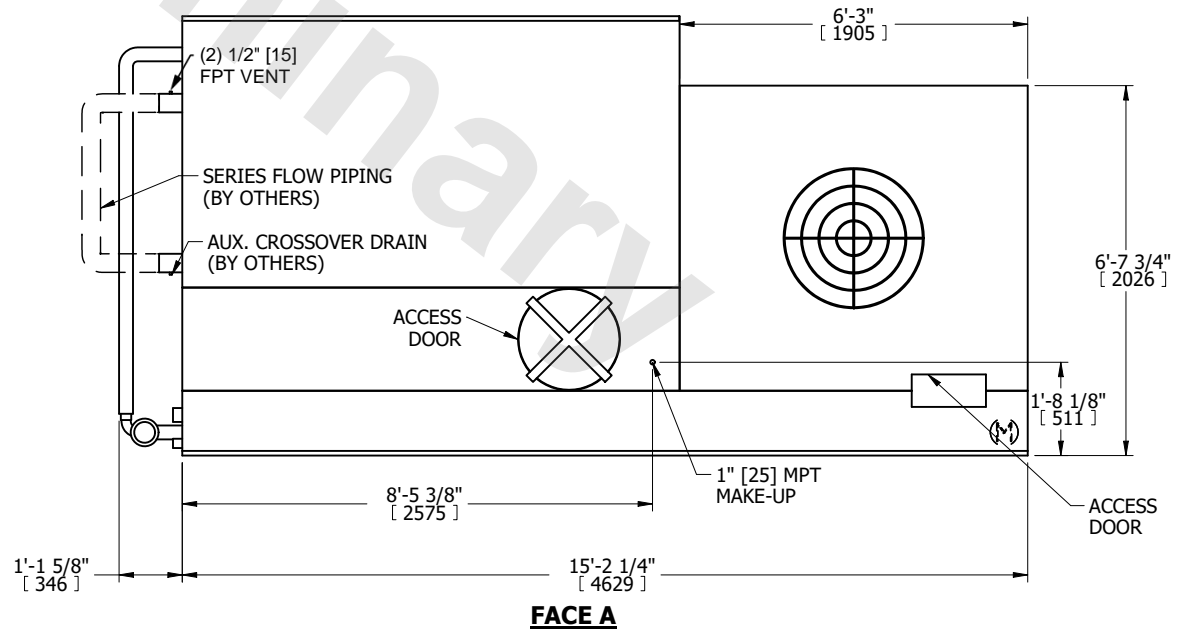

| | | | |
|----------|-----------------|------|-----------|
| DWG. # | WV050910-DRD-SF | REV. | - |
| SERIAL # | | DATE | 11/4/2024 |

- NOTES:
- (M)- FAN MOTOR LOCATION
 - MPT DENOTES MALE PIPE THREAD
FPT DENOTES FEMALE PIPE THREAD
BFW DENOTES BEVELED FOR WELDING
GVD DENOTES GROOVED
FLG DENOTES FLANGE
PE DENOTES PLAIN END
 - +UNIT WEIGHT DOES NOT INCLUDE ACCESSORIES (SEE ACCESSORY DRAWINGS)
 - 3/4" [19mm] DIA. MOUNTING HOLES. REFER TO RECOMMENDED STEEL SUPPORT DRAWING
 - DIMENSIONS LISTED AS FOLLOWS: ENGLISH FT IN [METRIC] [mm]
 - * - APPROXIMATE DIMENSIONS DO NOT USE FOR PRE-FABRICATION OF CONNECTING PIPING.
 - MAKE-UP WATER PRESSURE
20 psi [137 kPa] MIN, 50 psi [344 kPa] MAX
 - SERIES FLOW PIPING AND AUX. CROSSOVER DRAIN ARE BY OTHERS

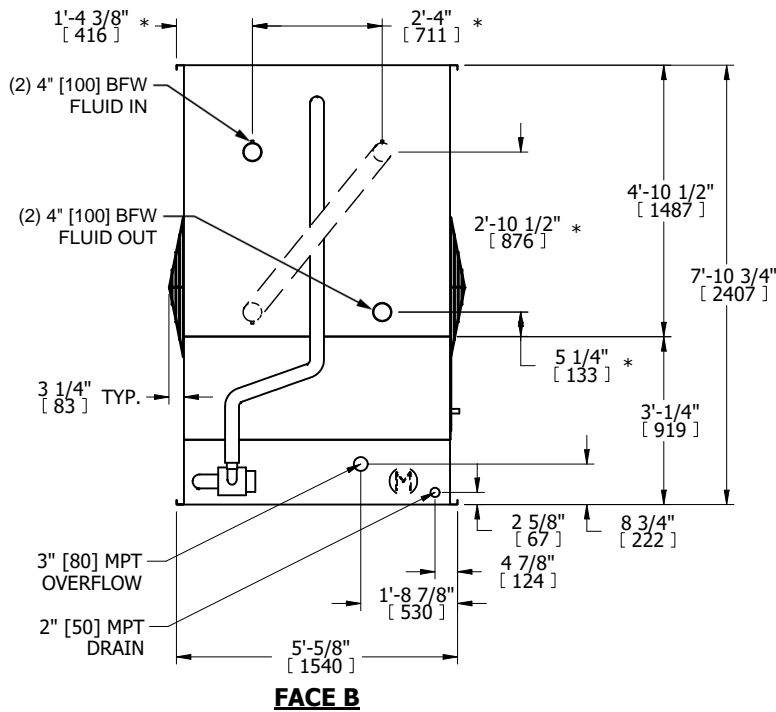
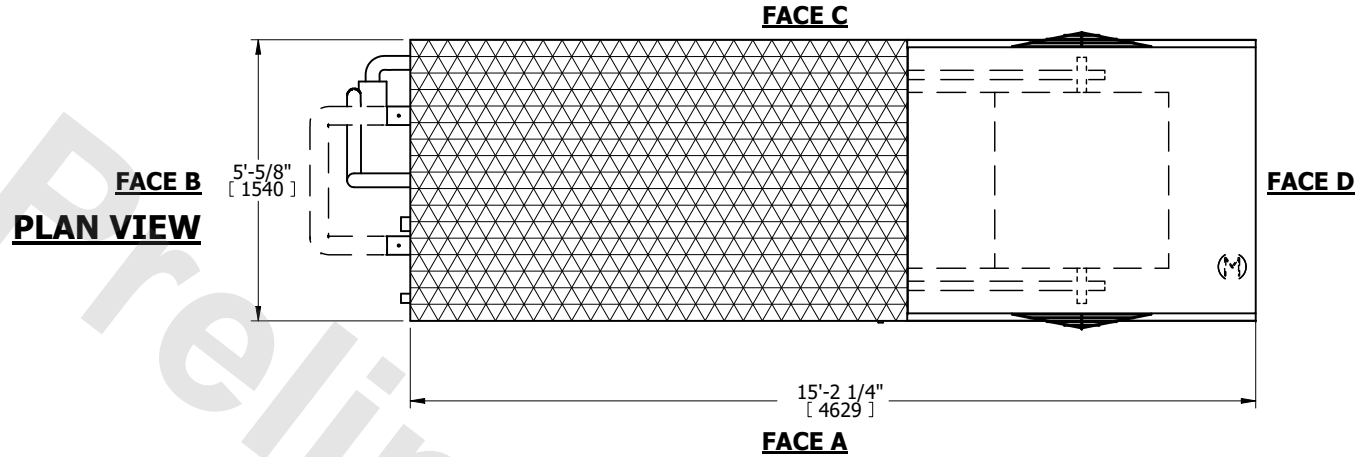

| | | | | | | | | | |
|-----------------|----------------------|------------------|-----------------------|-------------------------|----------------------|--------------------------|---|-----------|--|
| SHIPPING WEIGHT | 6470 lbs+ [2935] kg+ | OPERATING WEIGHT | 10350 lbs+ [4695] kg+ | HEAVIEST SECTION WEIGHT | 6470 lbs+ [2935] kg+ | NO. OF SHIPPING SECTIONS | 1 | DRAWN BY: | |
|-----------------|----------------------|------------------|-----------------------|-------------------------|----------------------|--------------------------|---|-----------|--|