

# EVAPCO, INC.



UNIT <b>EVAPORATIVE CONDENSER</b>	MODEL # PHC-S251	SCALE	DWG. # HCS121208-DRC-ST	REV. -	DATE 11/2/2024	SERIAL #
--------------------------------------	---------------------	-------	----------------------------	-----------	-------------------	----------

**NOTES:**

- (M)- FAN MOTOR LOCATION
- HEAVIEST SECTION IS UPPER SECTION
- MPT DENOTES MALE PIPE THREAD  
FPT DENOTES FEMALE PIPE THREAD  
BFW DENOTES BEVELED FOR WELDING  
GVD DENOTES GROOVED
- +UNIT WEIGHT DOES NOT INCLUDE ACCESSORIES (SEE ACCESSORY DRAWINGS)
- MAKE-UP WATER PRESSURE  
20 psi MIN [137 kPa], 50 psi MAX [344 kPa]
- 3/4" DIA. MOUNTING HOLES. REFER TO RECOMMENDED STEEL SUPPORT DRAWING.
- \*- APPROXIMATE DIMENSIONS DO NOT USE FOR PRE-FABRICATION OF CONNECTION PIPING.
- \*\*-UNITS WITH 20HP PER FAN REQUIRE A TALLER FAN CYLINDER, ADD 5" TO THESE DIMENSIONS.
- DIMENSIONS LISTED AS FOLLOWS: ENGLISH IN [METRIC] [mm]

**FACE 2  
PLAN VIEW**

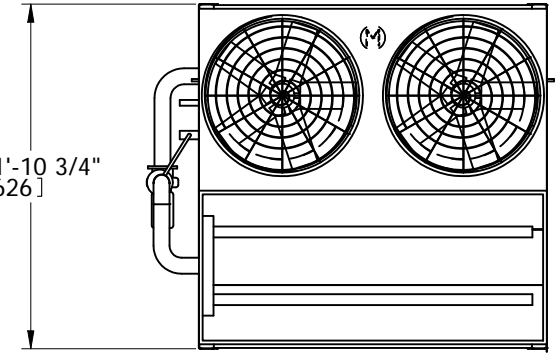

**FACE 1**

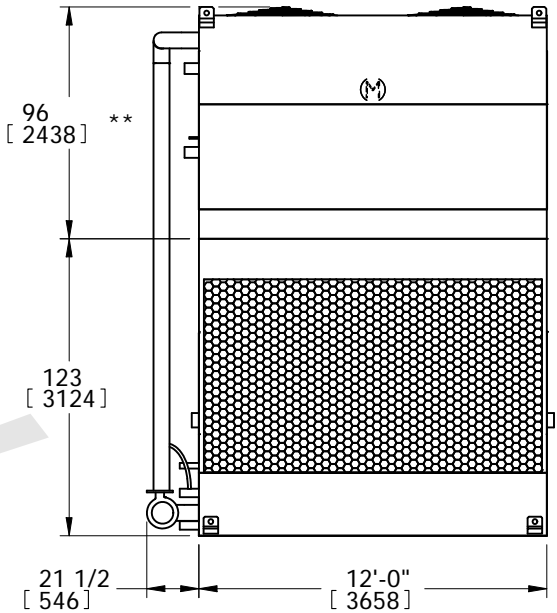

**FACE 1**

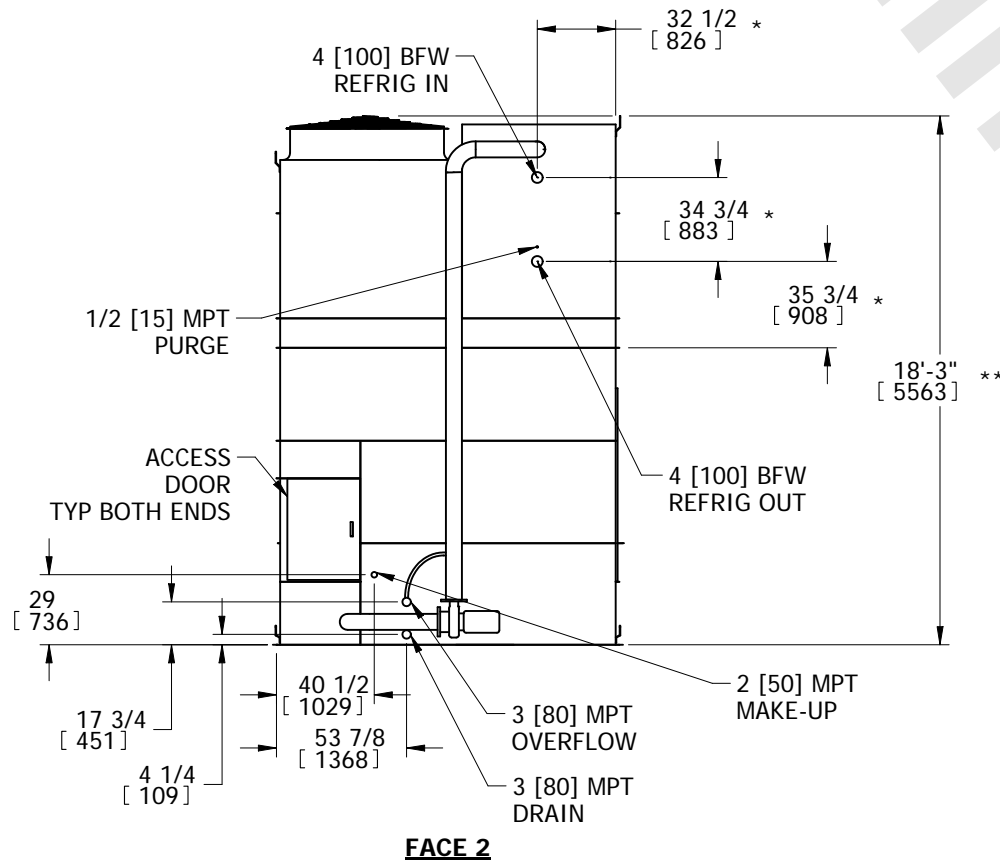

**FACE 2**

SHIPPING WEIGHT 12780 lbs+ [5800] kg+	OPERATING WEIGHT 18170 lbs+ [8245] kg+	HEAVIEST SECTION WEIGHT 7620 lbs+ [3460] kg+	NO. OF SHIPPING SECTIONS 2	DRAWN BY: TLS
--	---	---	-------------------------------	------------------