

EVAPCO, INC.



UNIT EVAPORATIVE CONDENSER	MODEL # PHC-L525	SCALE	DWG. # HCS1224S08-DRC-ST	REV. -	DATE 11/2/2024	SERIAL #
--------------------------------------	---------------------	-------	-----------------------------	-----------	-------------------	----------

- NOTES:
- (M)- FAN MOTOR LOCATION
 - HEAVIEST SECTION IS UPPER SECTION
 - MPT DENOTES MALE PIPE THREAD
FPT DENOTES FEMALE PIPE THREAD
BFW DENOTES BEVELED FOR WELDING
GVD DENOTES GROOVED
 - +UNIT WEIGHT DOES NOT INCLUDE ACCESSORIES (SEE ACCESSORY DRAWINGS)
 - MAKE-UP WATER PRESSURE
20 psi MIN [137 kPa], 50 psi MAX [344 kPa]
 - 3/4" DIA. MOUNTING HOLES. REFER TO RECOMMENDED STEEL SUPPORT DRAWING.
 - *- APPROXIMATE DIMENSIONS DO NOT USE FOR PRE-FABRICATION OF CONNECTION PIPING.
 - **-UNITS WITH 20HP PER FAN REQUIRE A TALLER FAN CYLINDER, ADD 5" TO THESE DIMENSIONS.
 - DIMENSIONS LISTED AS FOLLOWS: ENGLISH IN [METRIC] [mm]

**FACE 2
PLAN VIEW**

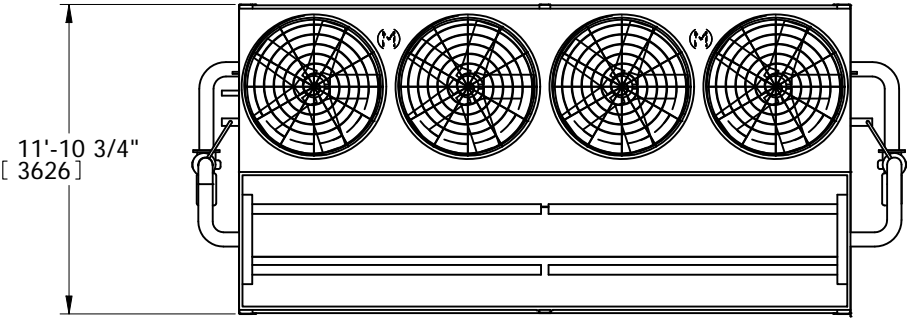

FACE 1

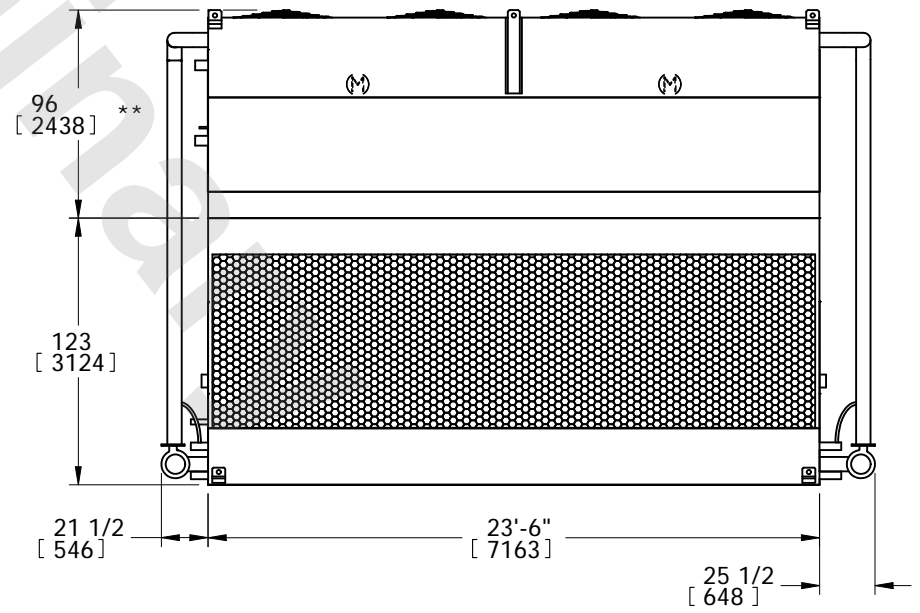
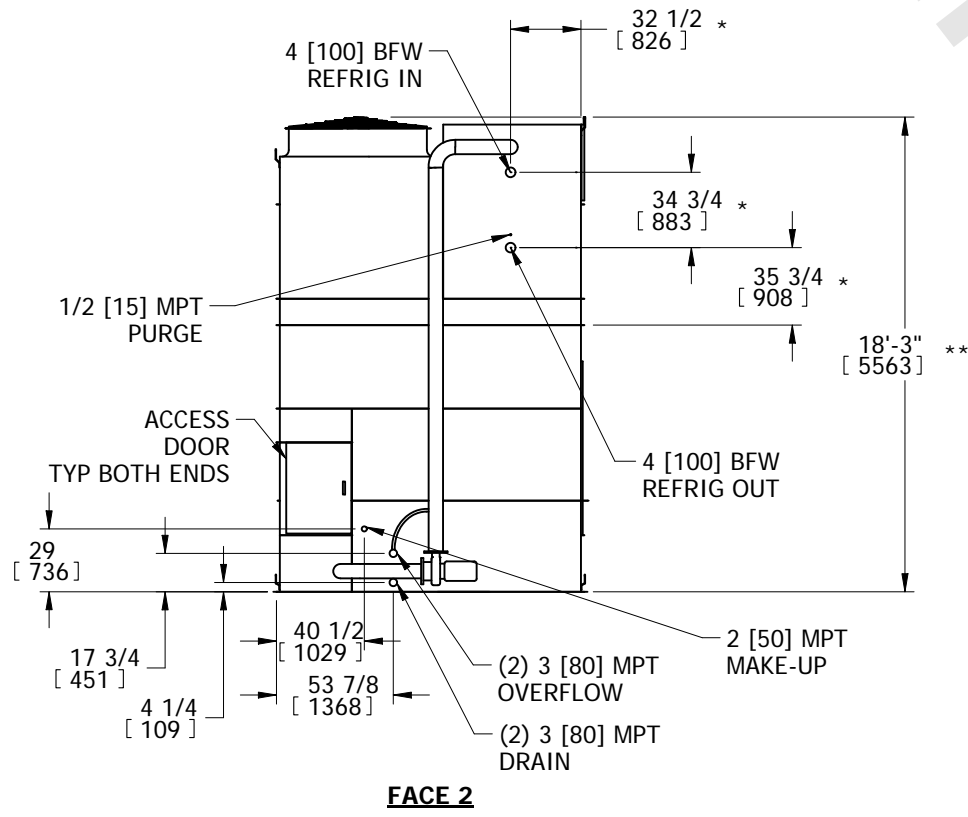

FACE 1

FACE 2

SHIPPING WEIGHT 23720 lbs+ [10760] kg+	OPERATING WEIGHT 34430 lbs+ [15620] kg+	HEAVIEST SECTION WEIGHT 14920 lbs+ [6770] kg+	NO. OF SHIPPING SECTIONS 2	DRAWN BY: TLS
---	--	--	-------------------------------	------------------