

# EVAPCO, INC.



UNIT <b>CONDENSER</b>	MODEL # eco-ATC-1555A	SCALE N.T.S.	DWG. # EG241808-DRA-ST	REV. -	DATE 11/5/2024	SERIAL #
--------------------------	--------------------------	-----------------	---------------------------	-----------	-------------------	----------

- NOTES:
- (M)- FAN MOTOR LOCATION
  - HEAVIEST SECTION IS UPPER SECTION
  - MPT DENOTES MALE PIPE THREAD  
FPT DENOTES FEMALE PIPE THREAD  
BFW DENOTES BEVELED FOR WELDING
  - +UNIT WEIGHT DOES NOT INCLUDE ACCESSORIES (SEE ACCESSORY DRAWINGS)
  - MAKE-UP WATER PRESSURE  
20 psi MIN [137 kPa], 50 psi MAX [344 kPa]
  - \* -APPROXIMATE DIMENSIONS DO NOT USE FOR PRE-FABRICATION OF CONNECTING PIPING
  - VENT PROVIDED ON CLOSED CIRCUIT COOLERS ONLY

Preliminary

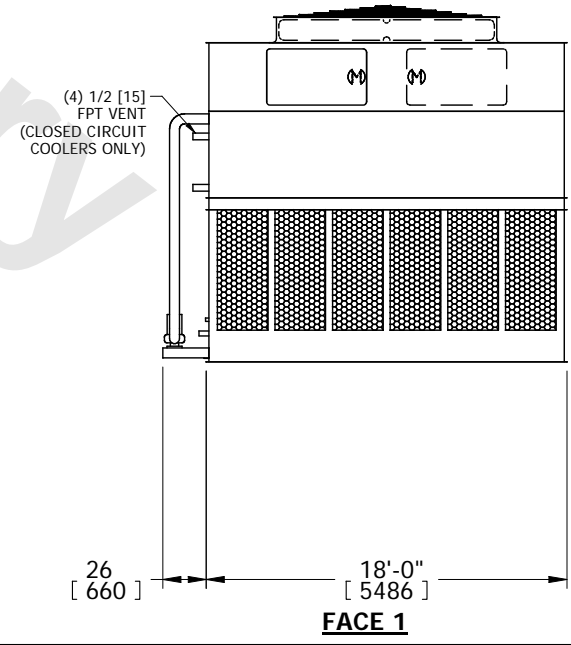
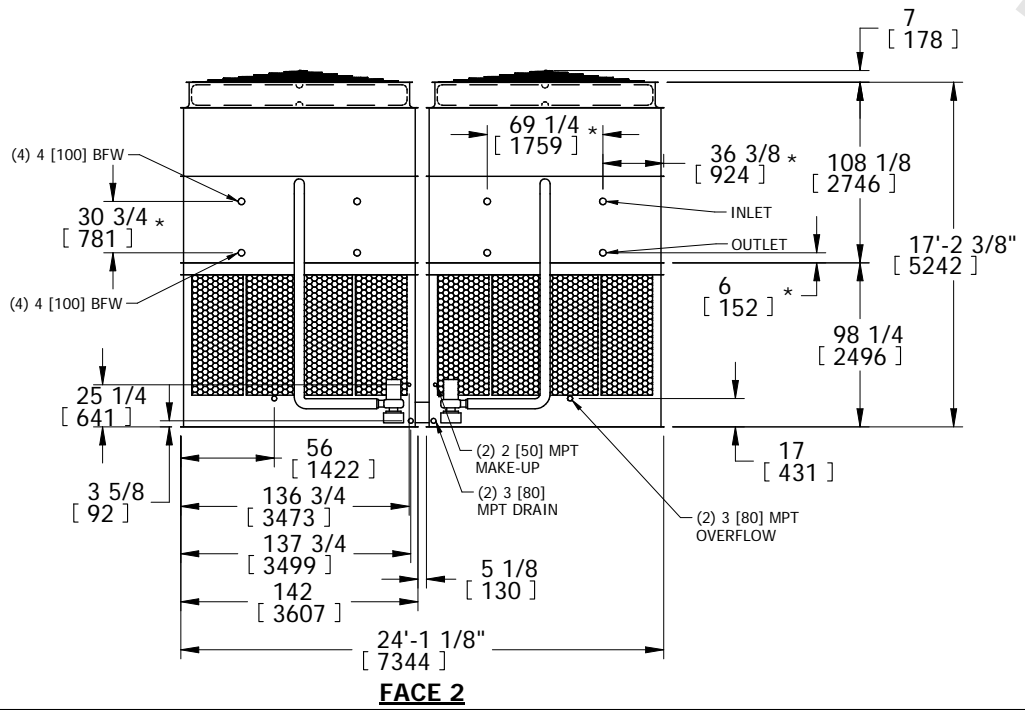
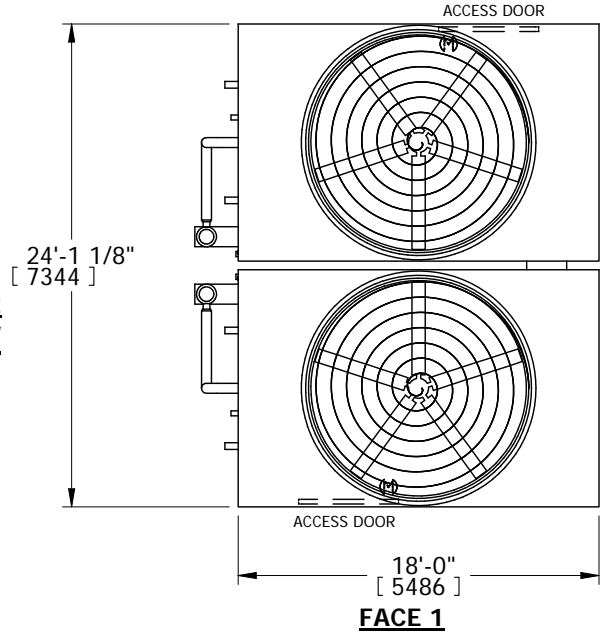

SHIPPING WEIGHT <b>58280 lbs+ [26440] kg+</b>	OPERATING WEIGHT <b>78760 lbs+ [35725] kg+</b>	HEAVIEST SECTION WEIGHT <b>25220 lbs+ [11440] kg+</b>	NO. OF SHIPPING SECTIONS <b>4</b>
--	---	--	--------------------------------------