

UNIT	COOLING TOWER	
MODEL #	AT 17-2J14	SCALE NTS



DWG. #	CT4C071424-DRA-ST	REV	-
SERIAL #		DATE:	10/14/2024

**NOTES:**

1. (M)- FAN MOTOR LOCATION
2. HEAVIEST SECTION IS FAN/CASING SECTION
3. MPT DENOTES MALE PIPE THREAD  
FPT DENOTES FEMALE PIPE THREAD  
BFW DENOTES BEVELED FOR WELDING  
GVD DENOTES GROOVED  
FLG DENOTES FLANGE
4. +UNIT WEIGHT DOES NOT INCLUDE ACCESSORIES (SEE ACCESSORY DRAWINGS)
5. 3/4" [19MM] DIA. MOUNTING HOLES. REFER TO RECOMMENDED STEEL SUPPORT DRAWING
6. DIMENSIONS LISTED AS FOLLOWS:  
ENGLISH FT-IN  
[METRIC] [mm]
7. MAKE-UP WATER PRESSURE  
20 psi MIN [137 kPa], 50 psi MAX [344 kPa]

**FACE B  
PLAN VIEW**

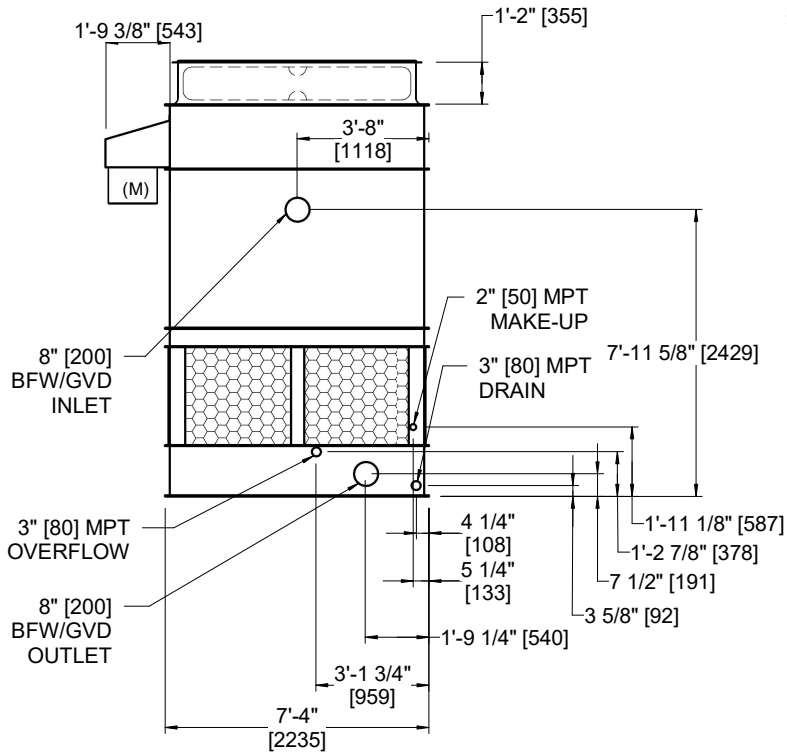
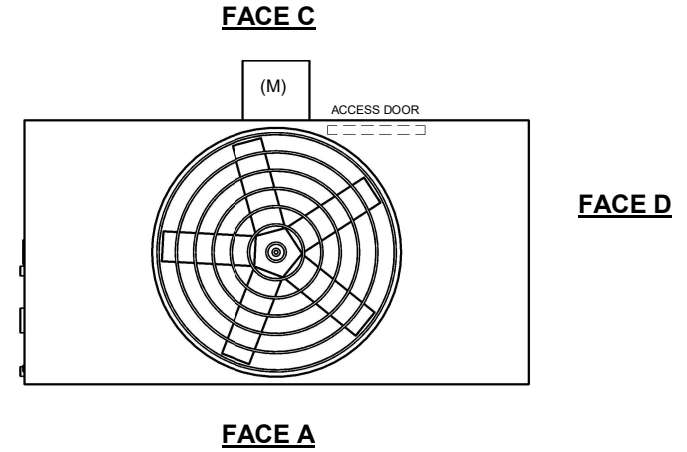

**FACE B**

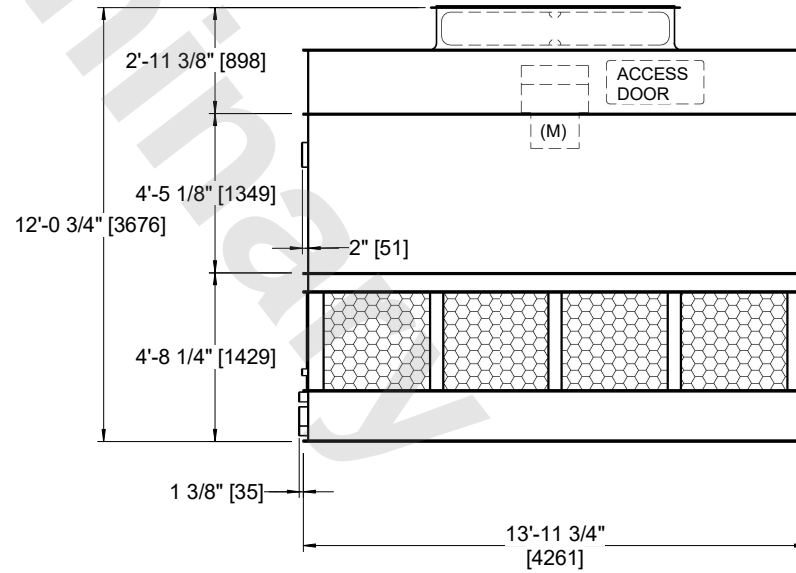

**FACE A**

SHIPPING WEIGHT	5380 lbs+ [2445] kg+	OPERATING WEIGHT	9310 lbs+ [4225] kg+	HEAVIEST SECTION WEIGHT	3480 lbs+ [1580] kg+	NO. OF SHIPPING SECTIONS	2	DRAWN BY:	JLG
-----------------	----------------------	------------------	----------------------	-------------------------	----------------------	--------------------------	---	-----------	-----