

|         |               |           |
|---------|---------------|-----------|
| UNIT    | COOLING TOWER |           |
| MODEL # | AT 19-3L14    | SCALE NTS |



|          |                 |      |           |
|----------|-----------------|------|-----------|
| DWG. #   | T3091436-DRD-ST | REV. | -         |
| SERIAL # |                 | DATE | 10/9/2024 |

- NOTES:
- (M)- FAN MOTOR LOCATION
  - HEAVIEST SECTION IS UPPER SECTION
  - MPT DENOTES MALE PIPE THREAD  
FPT DENOTES FEMALE PIPE THREAD  
BFW DENOTES BEVELED FOR WELDING  
GVD DENOTES GROOVED  
FLG DENOTES FLANGE
  - +UNIT WEIGHT DOES NOT INCLUDE ACCESSORIES (SEE ACCESSORY DRAWINGS)
  - MAKE-UP WATER PRESSURE  
20 psi MIN [137 kPa], 50 psi MAX [344 kPa]
  - 3/4" [19MM] DIA. MOUNTING HOLES. REFER TO RECOMENDED STEEL SUPPORT DRAWING.
  - DIMENSIONS LISTED AS FOLLOWS:  
ENGLISH FT-IN  
[METRIC] [mm]

**FACE B**  
**PLAN VIEW**

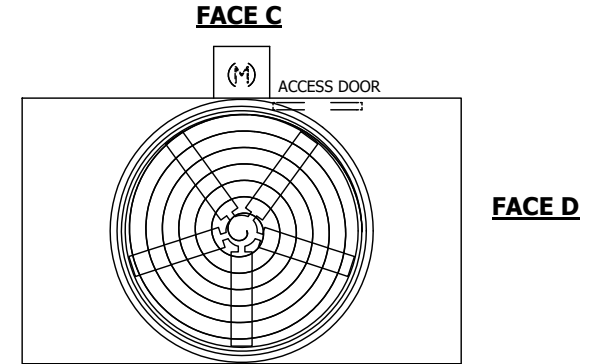

**FACE A**

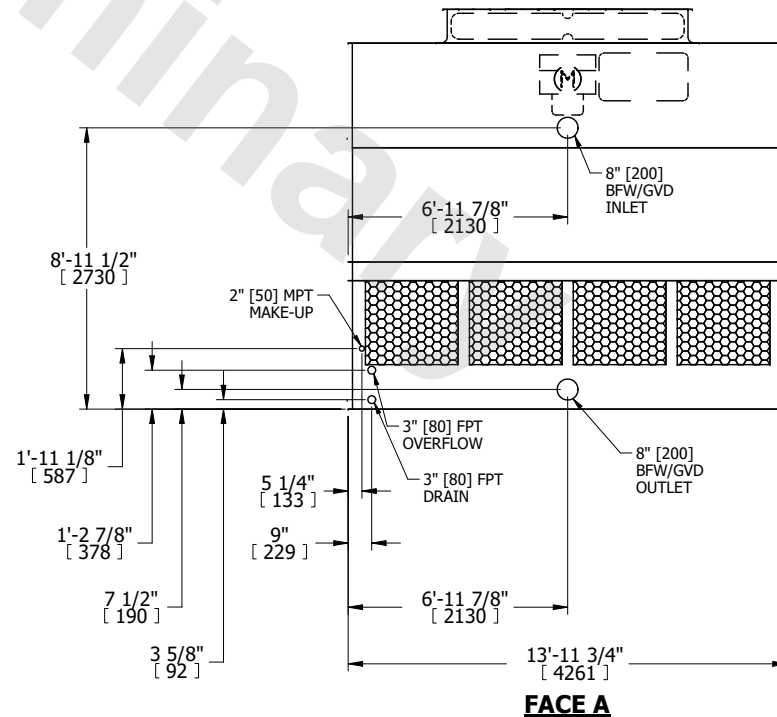
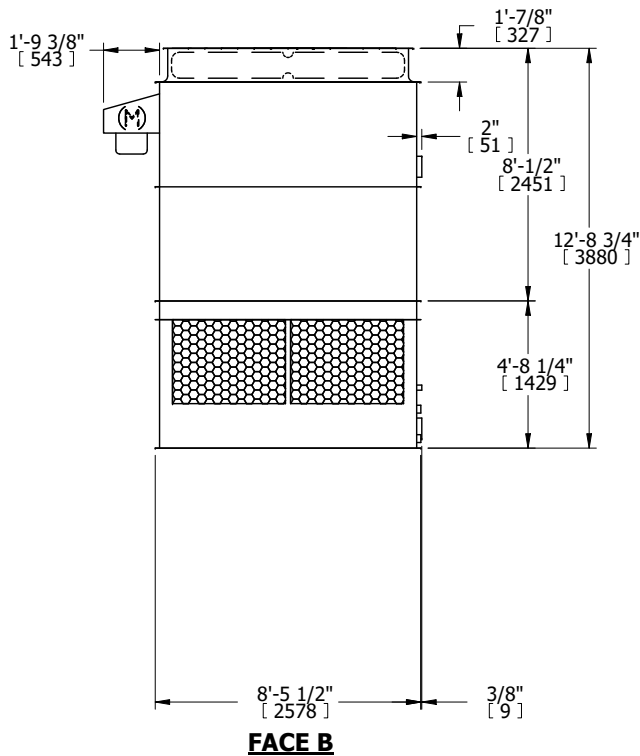

|                 |                      |                  |                       |                         |                      |                          |   |           |     |
|-----------------|----------------------|------------------|-----------------------|-------------------------|----------------------|--------------------------|---|-----------|-----|
| SHIPPING WEIGHT | 6310 lbs+ [2865] kg+ | OPERATING WEIGHT | 10820 lbs+ [4910] kg+ | HEAVIEST SECTION WEIGHT | 4260 lbs+ [1935] kg+ | NO. OF SHIPPING SECTIONS | 2 | DRAWN BY: | JLG |
|-----------------|----------------------|------------------|-----------------------|-------------------------|----------------------|--------------------------|---|-----------|-----|