

UNIT	COOLING TOWER	
MODEL #	AT 314-4N72	SCALE NTS

EVAPCO, INC.

DWG. #	T4147248-DRA-ST	REV.	-
SERIAL #		DATE	3/17/2025

NOTES:

1. (M)- FAN MOTOR LOCATION
2. HEAVIEST SECTION IS UPPER SECTION
3. MPT DENOTES MALE PIPE THREAD
FPT DENOTES FEMALE PIPE THREAD
BFW DENOTES BEVELED FOR WELDING
GVD DENOTES GROOVED
FLG DENOTES FLANGE
PE DENOTES PLAIN END
4. +UNIT WEIGHT DOES NOT INCLUDE ACCESSORIES (SEE ACCESSORY DRAWINGS)
5. MAKE-UP WATER PRESSURE
20 psi MIN [137 kPa], 50 psi MAX [344 kPa]
6. 3/4" [19MM] DIA. MOUNTING HOLES.
REFER TO RECOMMENDED STEEL SUPPORT DRAWING
7. DIMENSIONS LISTED AS FOLLOWS:
ENGLISH FT-IN
[METRIC] [mm]

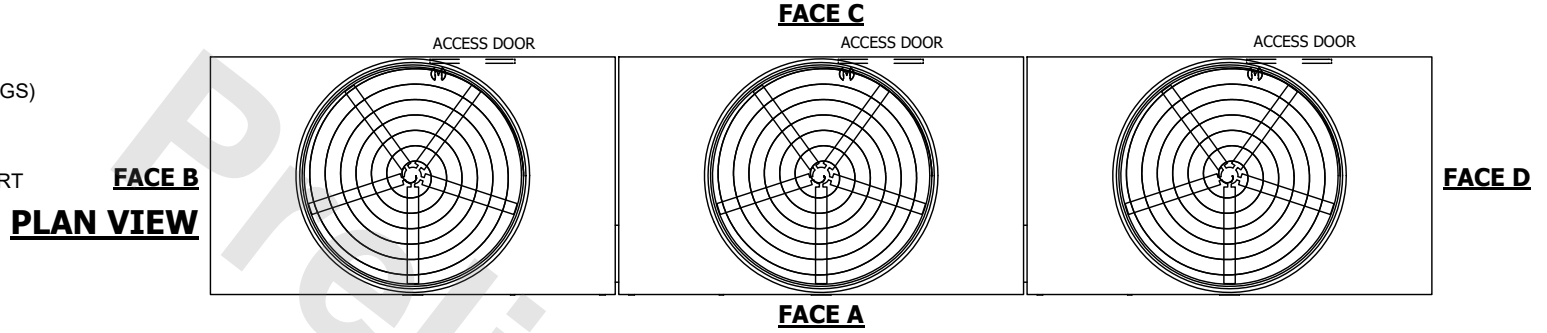

SHIPPING WEIGHT	60240 lbs+ [27325] kg+	OPERATING WEIGHT	104430 lbs+ [47370] kg+	HEAVIEST SECTION WEIGHT	12900 lbs+ [5855] kg+	NO. OF SHIPPING SECTIONS	6	DRAWN BY:	MER
-----------------	------------------------	------------------	-------------------------	-------------------------	-----------------------	--------------------------	---	-----------	-----