

EVAPCO, INC.



UNIT COOLING TOWER	MODEL # AT 420-4J36	SCALE N.T.S.	DWG. # T36M3648-DRE-ST	REV. -	DATE 10/1/2024	SERIAL #
------------------------------	------------------------	-----------------	---------------------------	-----------	-------------------	----------

- NOTES:
- (M)- FAN MOTOR LOCATION
 - HEAVIEST SECTION IS UPPER SECTION
 - MPT DENOTES MALE PIPE THREAD
FPT DENOTES FEMALE PIPE THREAD
BFW DENOTES BEVELED FOR WELDING
 - +UNIT WEIGHT DOES NOT INCLUDE ACCESSORIES (SEE ACCESSORY DRAWINGS)
 - MAKE-UP WATER PRESSURE
20 psi MIN [137 kPa], 50 psi MAX [344 kPa]

**FACE 2
PLAN VIEW**

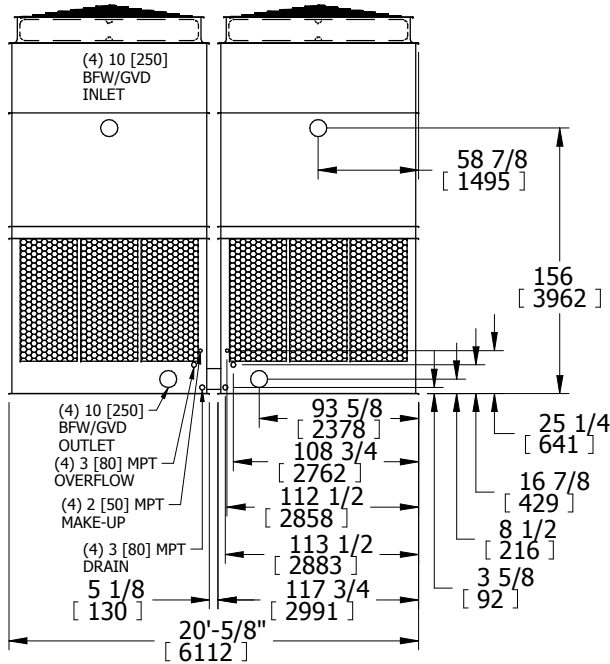

FACE 2

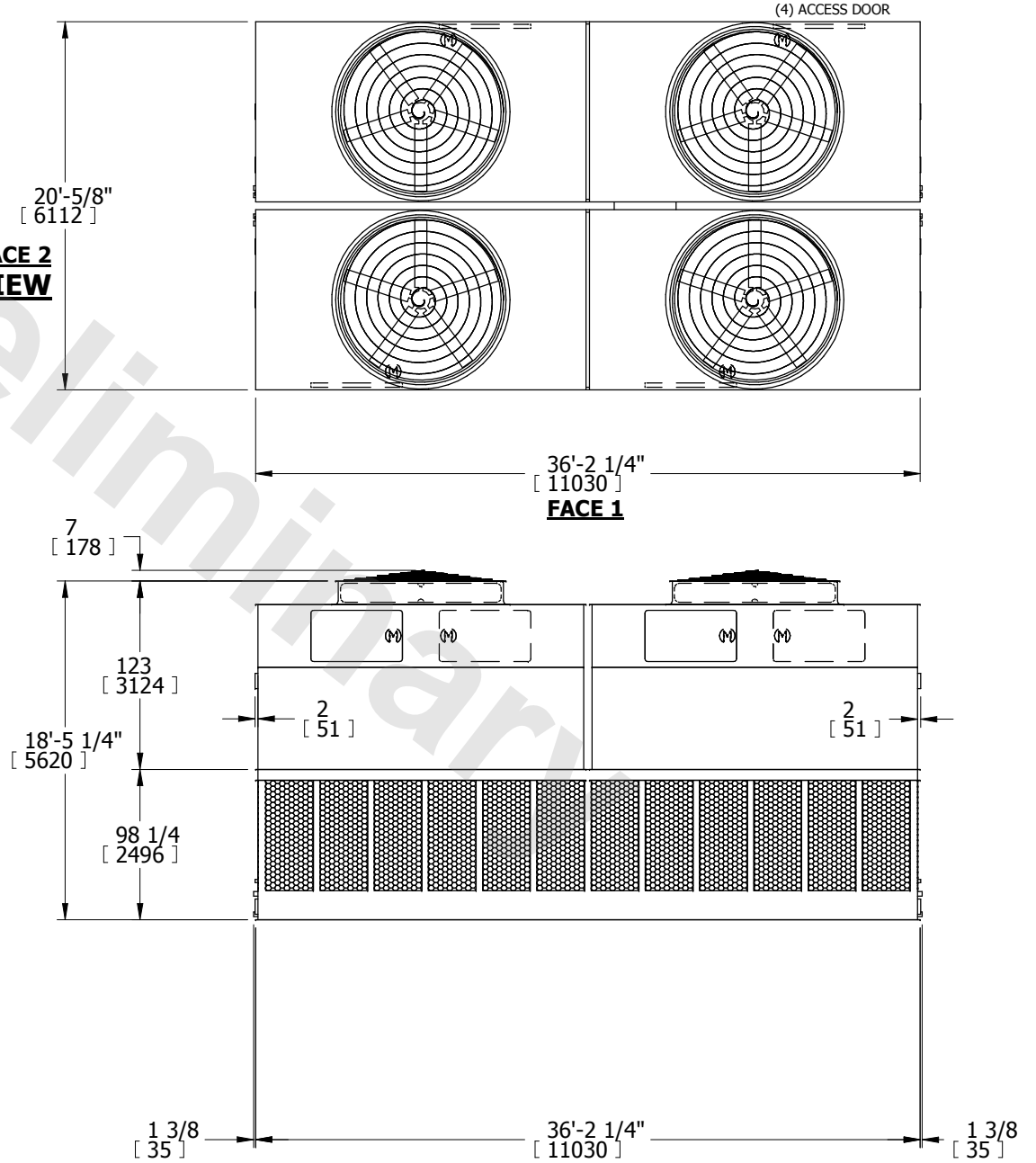

FACE 1

SHIPPING WEIGHT 42660 lbs+ [19350] kg+	OPERATING WEIGHT 76620 lbs+ [34754] kg+	HEAVIEST SECTION WEIGHT 7480 lbs+ [3393] kg+	NO. OF SHIPPING SECTIONS 6
---	--	---	-------------------------------