



for LIFE

CLOSED CIRCUIT COOLERS



# eco-LSWE eco-LRWB Coolers



† Mark owned by the Cooling Technology Institute

**eco** ENVIRONMENTALLY CONSCIOUS OPERATION  
Featuring Water & Energy Conserving Technology with Plume Abatement





## EVAPCO is more than a name.

It is a pledge to make everyday life easier, more comfortable, more reliable, and more sustainable for people everywhere. How do we fulfill that promise? It is simple.

### We never stop innovating.

At EVAPCO, we do not just talk about innovation, It is ingrained in our workflow. Guided by our annually developed R&D plans, we set out to find groundbreaking solutions that transform the way the world works for the better. It is why we have more than 200 active patents worldwide.

### We craft exceptionally built solutions.

As an employee-owned company, we take pride in our work. We are proud to be one of the most experienced teams of engineers and craftsmen in the industry. This translates into solutions that are always exceptionally built. EVAPCO has an unwavering commitment to provide “best in class” heat transfer solutions and services.

### We guarantee performance.

Every EVAPCO solution is put through rigorous research and testing to ensure maximum efficiency and reliability. But we do not stop there. EVAPCO is an industry leader in independent, third-party performance certifications. These certifications guarantee our performance metrics—so that you can plan your projects with complete peace of mind.

### We protect the environment.

Innovation and environmental sustainability go hand-in-hand at EVAPCO. EVAPCO’s industrial heat transfer equipment not only conserves natural resources and helps reduce noise pollution, they also feature recycled steel content in their construction. Our stainless steel units are constructed of panels that contain up to 75% recycled content; over 80% in galvanized units construction. From sound reduction to water conservation to chemical elimination, we are constantly developing new technologies that deliver the ultimate operating advantages for our clients—and protect the planet for every generation that comes after us.



## Get to Know EVAPCO

- The global innovator in heat transfer solutions
- Serving the commercial HVAC, Industrial Refrigeration, Power Generation, and Industrial Process markets
- Founded in 1976
- Employee-owned
- 33 locations in 14 countries
- More than 200+ sales offices worldwide

## Learn More Now

Visit [evapco.com](http://evapco.com) to download product catalogs, view complete product specifications, and more.

## Table of Contents

Corporate .....	2
eco-LSWE and eco-LRWB Principle of Operation .....	3
Application Versatility .....	4
eco-LSWE Design and Construction Features .....	5-6
eco-LRWB Design and Construction Features .....	7-8
Innovative Design Features .....	9-10
Sage Water & Energy Conservation Control System .....	11-12
Water Treatment Solutions .....	13-14
eco-LSWE Stainless Steel Options .....	15
eco-LRWB Stainless Steel Options .....	16
Coil Connection Options .....	17
Low Sound Solutions .....	18
eco-LSWE Discharge & Intake Attenuation .....	19
eco-LRWB Discharge & Intake Attenuation .....	20
Freeze Protection Options .....	21-22
Heat Loss & Discharge Hood Dimensions .....	23
Steel Support .....	24
Specific Design Features .....	25
General Information .....	26
Engineering Data .....	27-43



## Low Sound and Low Rise Forced Draft Closed Circuit Coolers

Featuring Evapco's revolutionary **Ellipti-fin** coil with **CROSSCOOL** Internal Tube Enhancement, the eco-LSWE and eco-LRWB closed circuit coolers are the most energy and water efficient forced draft coolers available in the industry. This new and improved series of coolers is the ideal solution for indoor applications, confined layouts, low sound requirements and direct replacements to name a few. NOW, with Evapco's state-of-the-art spirally finned, internally enhanced coil technology, the eco-LSWE and eco-LRWB can replace existing forced draft equipment of the same boxsize and fan motor horsepower and provide up to an **ADDITIONAL 30%** in thermal capacity!!



**eco-LSWE**

The standard for forced draft centrifugal fan designs,  
Now more efficient than ever.

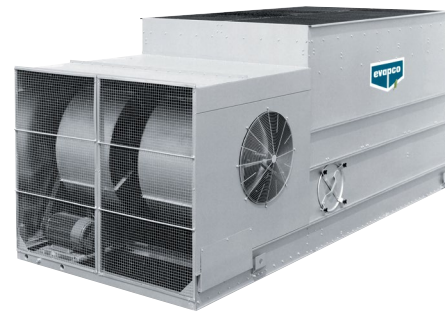

**eco-LRWB**

With the fan section located beside the heat transfer casing, this unit satisfies even the strictest of height requirements in a unitary, compact design.

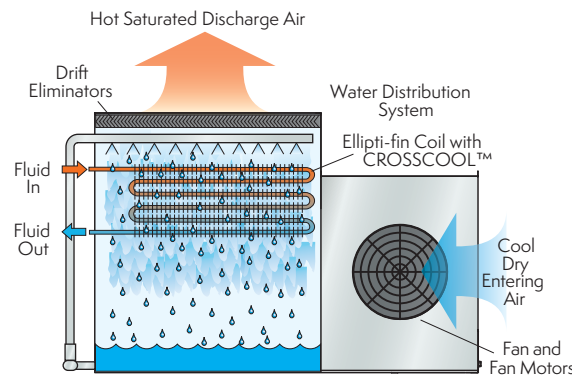
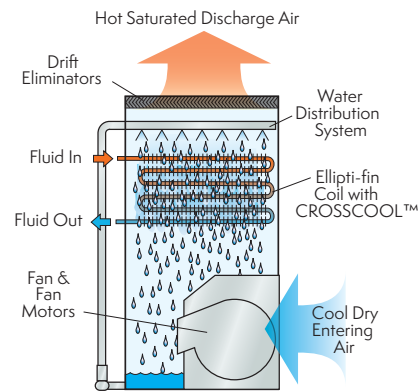

### Principle of Operation

The process fluid is circulated through the coil of the closed circuit cooler. Heat from the process fluid is dissipated through the coil tubes to the water cascading downward over the tubes. Simultaneously air is blown through the unit by the fans and travels upward over the coil opposite the water flow. A small portion of the water is evaporated which removes the heat. The warm moist air is forced to the top of the closed circuit cooler by the fan and is discharged to the atmosphere. The remaining water falls to the sump at the bottom of the cooler where it is recirculated by the pump up through the water distribution system and back down over the coils.

Centrifugal units are recommended for a wide range of installations. They are quiet, can easily be hidden, and are an excellent solution for installations where sound is sensitive, and when the unit must handle external static pressure.

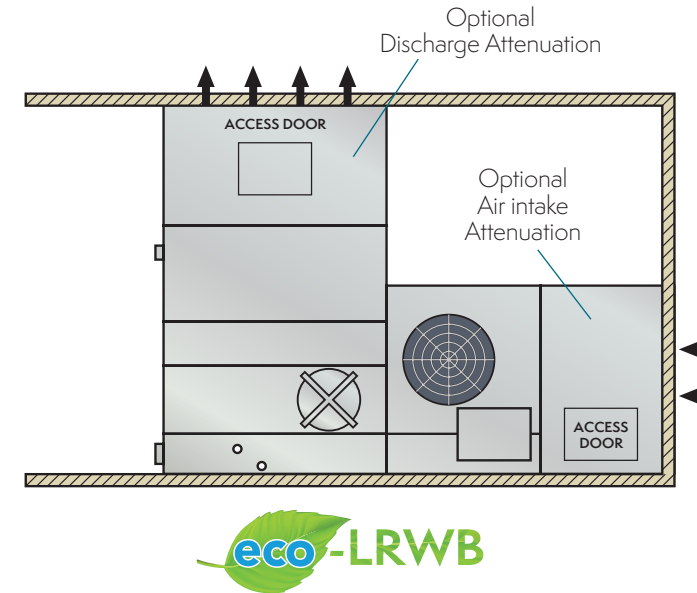

**NOTE:** eco-LRWB Shown Ducted on Both Inlet and Discharge

### Very Quiet Operation

Centrifugal fan units operate at low sound levels which make this design preferred for installations with external static pressure where noise is a concern. Additionally, since the sound from the fans is directional, single sided air entry models can be turned away from critical areas avoiding a sound problem. When even quieter operation is necessary, centrifugal fan models can be equipped with optional sound attenuation packages. See the Sound Reducing Options section of this catalog or consult the factory for details.

In addition, the eco-LRWB features a specially engineered fan enclosure and drive system that is designed to offer very quiet operation without the high cost of external attenuation packages. The eco-LRWB fan system was developed through hundreds of hours of laboratory tests resulting in the lowest standardized sound levels available in the industry. In fact, the sound level of the eco-LRWB on average is 2 dBA quieter than competitors' similar models.

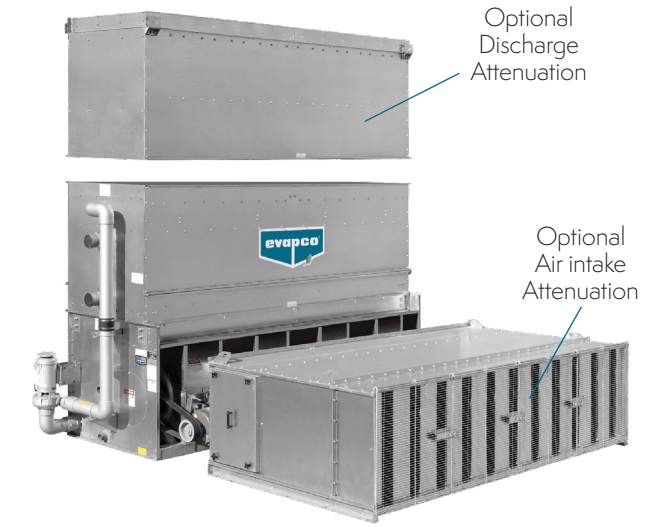

**eco-LSWE**

### Indoor Installation

All eco-LSWE and eco-LRWB closed circuit coolers can be installed indoors where they normally require ductwork to and from the unit. The design of the ductwork should be symmetrical to provide even air distribution across both intake and discharge openings. Guidelines for ducted applications:

- 1) The static pressure loss imposed by the ductwork must not exceed 1/2". The fan motor size must be increased for ESP up to 1/2".
- 2) For ducted installations, the solid bottom panel option must be ordered. On the eco-LRWB, blank off plates will also be provided in lieu of the side air inlet screens with this option.
- 3) **NOTE:** Access doors must be located in the ductwork (by others) for service to the fan drive components and water distribution system.

Drawings are available showing recommended ductwork connections. See EVAPCO's layout guidelines for additional information.



# eco-LSWE Design & Construction Features

## Ellipti-fin®

### Galvanized Steel Elliptical Spiral Fin Coil featuring CROSSCOOL™ Internal Tube Enhancement Technology

- The most efficient closed circuit cooler coil in the HVAC industry!
- Up to **30% ADDITIONAL** evaporative capacity and HIGHER dry bulb switchover temperatures
- All coil rows feature patent-pending finned Thermal-Pak® elliptical tube design
- Elliptical tube design results in lower airflow resistance than typical finned round tubes

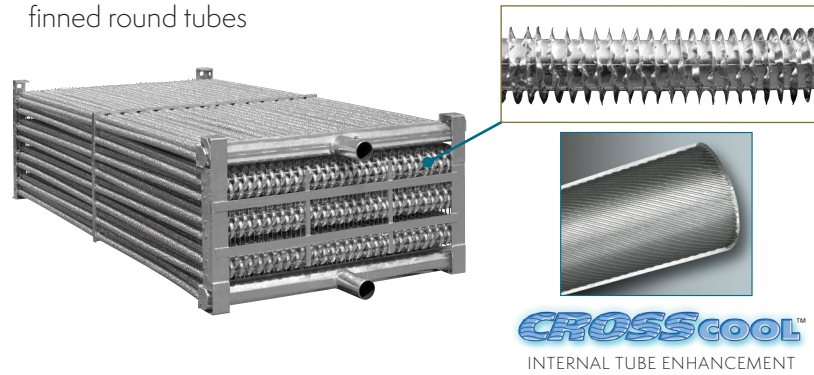

### Optional Factory Mounted Water Treatment Systems

The eco-LSWE is available with multiple water treatment options, including a **Pulse~Pure®** non-chemical or a **Smart Shield®** (not shown) solid chemical water treatment system. EVAPCO offers a number of environmentally sensitive alternatives for treating water in evaporative cooled equipment. Visit [evapco.com](http://evapco.com) for more information.



### The EVAPCO Performance Guarantee

Every eco-LSWE product is rigorously thermal performance tested by EVAPCO and then independently certified by the Cooling Technology Institute (CTI) so you know you're getting a solution that's guaranteed to get the job done.

\*Mark owned by the Cooling Technology Institute

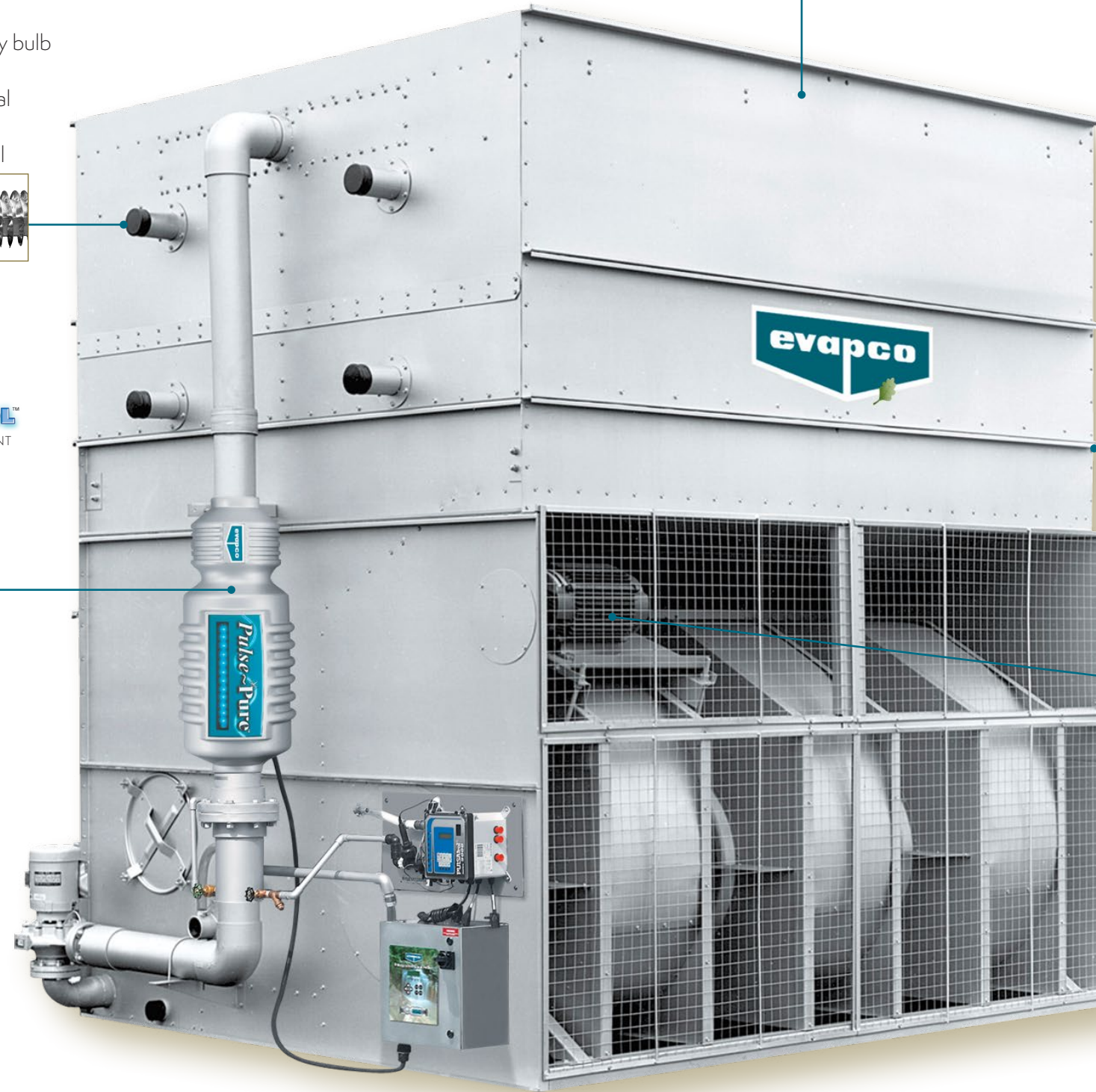

### Zero Maintenance PVC Spray Distribution Header with ZM®II Nozzles

- Fixed position nozzles require zero maintenance
- Large orifice nozzles prevent clogging

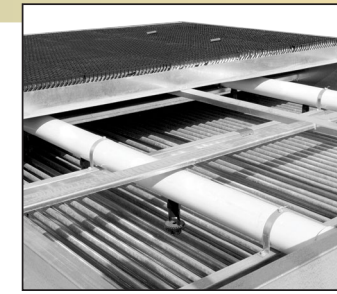

### Easy Field Assembly

- Ensures easy assembly and fewer fasteners
- Incorporates self-guiding channels to guide the coil casing section into position improving the quality of the field seam

### Clean Pan Design

- Sloped design allows water to drain completely from cold water basin
- Easier removal of dirt and debris



### Totally Enclosed Fan Motors

- Assures long life
- All normal maintenance can be performed quickly from outside the unit
- If required, motor may be easily removed
- Motors are now located outboard on multi-motor units for even easier drive system access
- Premium efficient inverter-ready motors are standard

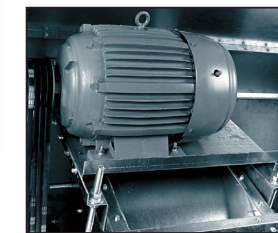

**Exclusive 5 Year  
Motor and Drive  
Warranty**



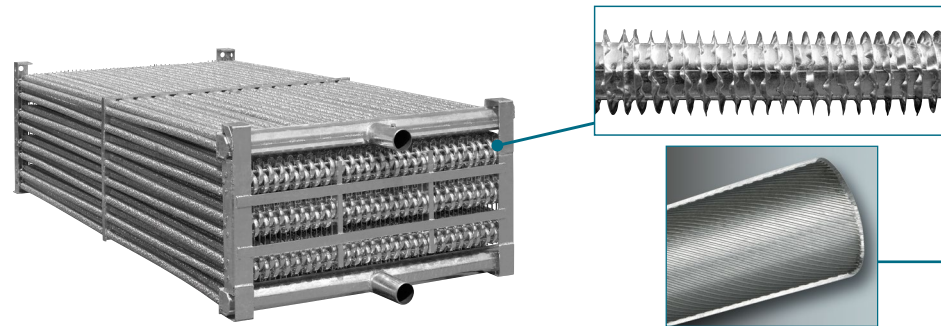

**Ellipti-fin®**

Galvanized Steel Elliptical Spiral Fin Coil featuring **CROSSCOOL™** Internal Tube Enhancement Technology

- The most efficient closed circuit cooler coil in the HVAC industry!
- Up to **30% ADDITIONAL** evaporative capacity and HIGHER dry bulb switchover temperatures
- All coil rows feature patent-pending finned Thermal-Pak® elliptical tube design
- Elliptical tube design results in lower airflow resistance than typical finned round tubes

**CROSSCOOL™**  
INTERNAL TUBE ENHANCEMENT

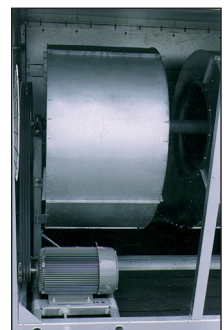
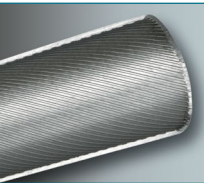

### Easy to Service Motor & Drive System

- Belt tensioning and bearing lubrication can be performed from outside the unit
- Locking mechanism can also be used as a wrench to adjust the belts
- Motor is fully accessible by removing one inlet screen
- Split fan housings allow removal of all mechanical equipment through the end of the unit



**Exclusive 5 Year Motor and Drive Warranty**

### Zero Maintenance PVC Spray Distribution Header with ZM®II Nozzles

- Fixed position nozzles require zero maintenance
- Large orifice nozzles prevent clogging

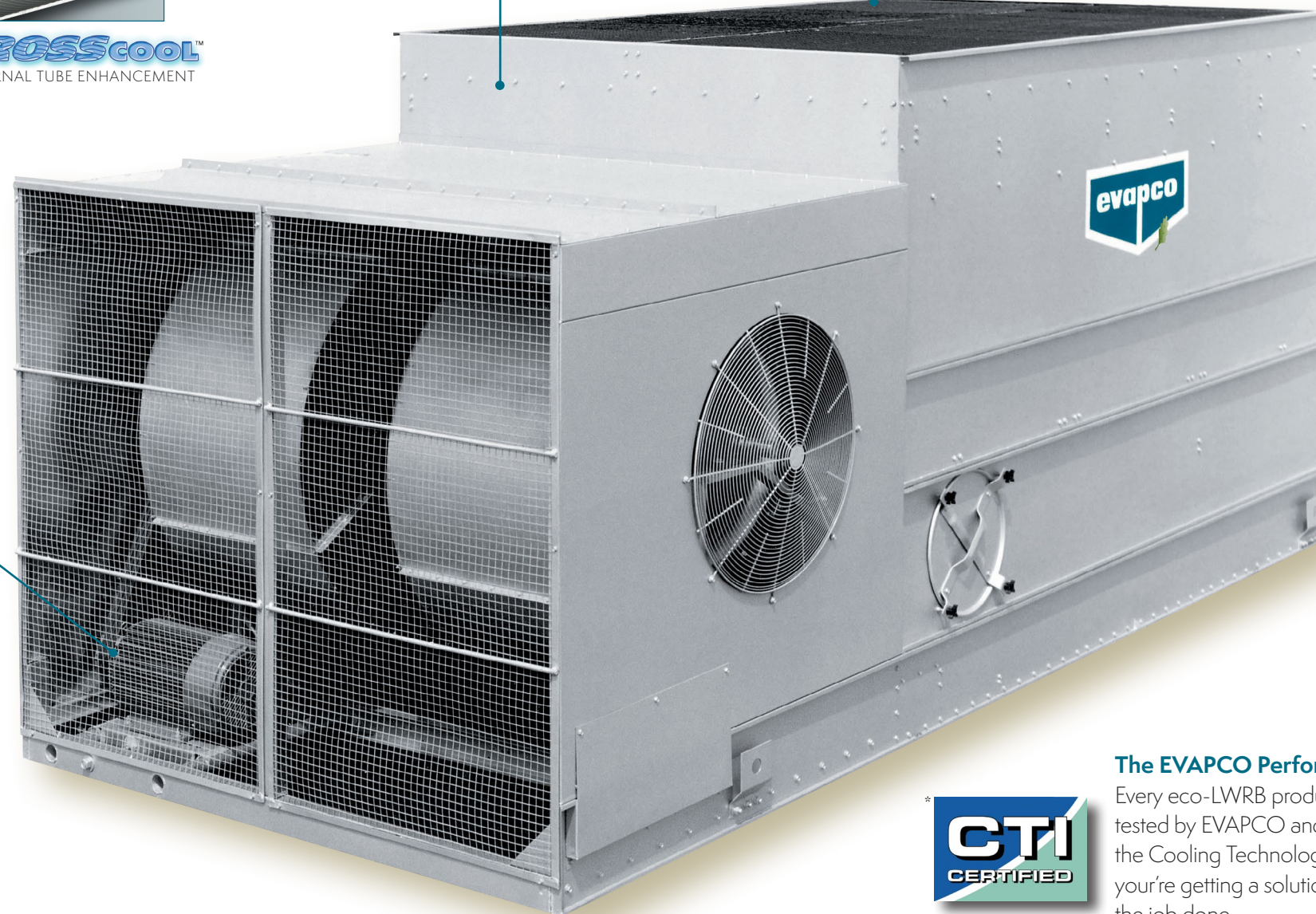
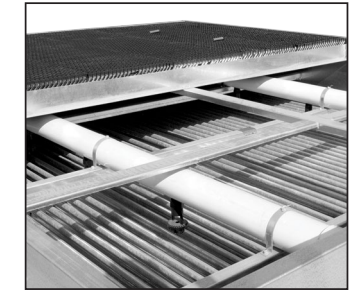

### Optional Factory Mounted Water Treatment Systems

The eco-LRWB is available with multiple water treatment options, including a **Pulse-Pure®** (not shown) non-chemical or a **Smart Shield®** (not shown) solid chemical water treatment system. EVAPCO offers a number of environmentally sensitive alternatives for treating water in evaporative cooled equipment. Each system includes all components required for an effective water treatment system; factory mounted and wired. Visit [evapco.com](http://evapco.com) for more information.

### The EVAPCO Performance Guarantee

Every eco-LRWB product is rigorously thermal performance tested by EVAPCO and then independently certified by the Cooling Technology Institute (CTI) so you know you're getting a solution that's guaranteed to get the job done.



\*Mark owned by the Cooling Technology Institute



## Ellipti-fin® Heat Transfer Coil

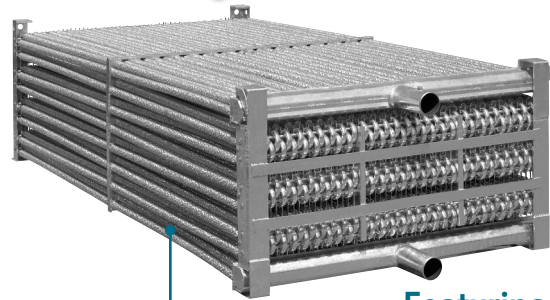

Featuring

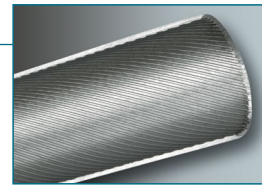
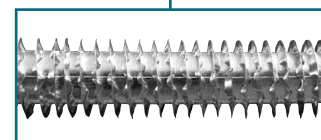

**CROSSCOOL™**  
INTERNAL TUBE ENHANCEMENT

### Galvanized steel elliptical Thermal-Pak® coil featuring CROSSCOOL™ Internal Tube Enhancement Technology

- The most efficient closed circuit cooler coil in the HVAC Industry
- Up to **30% ADDITIONAL** evaporative capacity and HIGHER dry bulb switchover temperatures
- Internal Tube Enhancement Provides additional evaporative capacity
- All rows finned
- Elliptical tube design results in lower airflow resistance than typical finned round tube designs

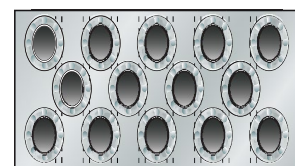

EVAPCO's Ellipti-fin®  
Finned Elliptical Tube

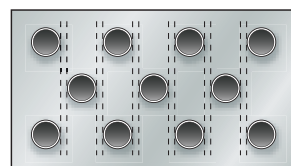

Competitors  
Round Tube Coil

The eco-LSWE and eco-LRWB line of closed circuit coolers utilize EVAPCO's patented Ellipti-fin® coil design, featuring CROSSCOOL™ internal tube enhancement ensures even greater operating efficiency. The elliptical tube design allows for closer tube spacing, resulting in greater surface area per plan area than round-tube coil designs.

In addition, the revolutionary Ellipti-fin® design uses elliptical spiral fin coil technology and has lower resistance to air flow than typical finned coil designs. This permits greater water loading and increases the evaporative and dry cooling capacity of the coil. EVAPCO's CROSSCOOL™ internal tube enhancement increases fluid turbulence through the coil, further increasing the evaporative capacity. The Ellipti-fin® coil featuring CROSSCOOL™ is the most efficient design available in the industry, providing up to **30% ADDITIONAL** evaporative capacity in the same box!

The coils are manufactured from high quality steel tubing following the most stringent quality control procedures. Each circuit is inspected to ensure the material quality and then tested before being assembled into a coil. Coils shall have a design pressure of 300 psi and shall be in compliance with ANSI/ASME B31.5, Refrigeration Piping and Heat Transfer Components. The coil assembly shall be strength tested in accordance with ASNI/ASME B31.5 and subsequently leak tested using air under water.

To protect the coil against corrosion, it is placed in a heavy steel frame and then the entire assembly is dipped into molten zinc (hot-dipped galvanized) at a temperature of approximately 800 °F.

**NOTE:** Closed Circuit Coolers should only be used on sealed, pressurized systems. Continual aeration of the water in an open system can cause corrosion inside the tubes of the coil leading to premature failure.

## Fan Motor Mount

TEFC fan motors are mounted in a convenient open area for ease of belt tensioning, motor lubrication and electrical connection. The motor base is designed for easy adjustment and is locked into position to maintain proper belt tension.

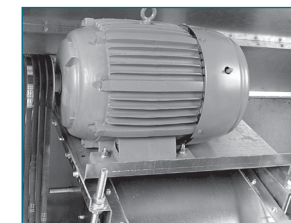

Example eco-LSWE Fan  
Motor Mount

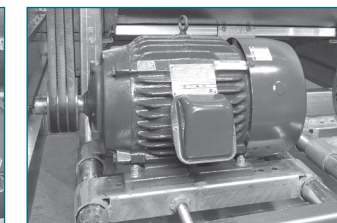

eco-LRWB Fan Motor Mount

## Fan Access-Split Housing

Another unique feature of the eco-LRWB closed circuit cooler is the split fan housing. The split fan housing on the eco-LRWB allows quick removal of the fans from the front end of the unit. This feature allows fan removal when units are placed side by side where space is minimal.

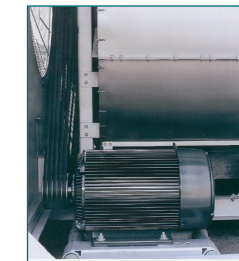

## Mechanical Drive System Access

The eco-LSWE and eco-LRWB mechanical drive systems are easy to maintain. Bearing lubrication and belt adjustment can be performed from outside the unit. There is no need to remove fan screens to maintain important drive components. In addition, the locking mechanism used to maintain belt tension can also work as a wrench to adjust the belt.

## Centrifugal Fan Assembly

Fans on eco-LSWE and eco-LRWB closed circuit coolers are of the forward curved centrifugal design with hot-dip galvanized steel construction. All fans are statically and dynamically balanced and are mounted in a hot-dip galvanized steel housing.

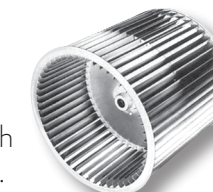

## Maintenance Free ZM®II Spray Nozzle Water Distribution System

EVAPCO'S Zero Maintenance ZM®II spray nozzle remains clog-free while providing even and constant water distribution for reliable, scale-free evaporative cooling under all operating conditions.



ZM®II Nozzle

The heavy duty nylon ZM®II spray nozzles have a 1-5/16" diameter opening and a 1-1/2" splash plate clearance. Furthermore, the fixed position ZM®II nozzles are mounted in corrosion-free PVC water distribution pipes that have threaded end caps. Together, these elements combine to provide unequalled coil coverage and scale prevention, and make the industry's best performing non-corrosive, maintenance-free water distribution system.

## Efficient Drift Eliminators

The eco-LSWE and eco-LRWB are provided with an efficient drift eliminator system that effectively reduces entrained water droplets from the air discharge to less than 0.001% of the spray water flow rate.

The eliminators are constructed of non-corrosive PVC with a multi-pass design for maximum drift reduction. They are assembled in modular sections for easy removal and access to the water distribution system.

In addition to reducing drift, the eliminators also function as effective debris screens which protect the spray system from sunlight and debris.

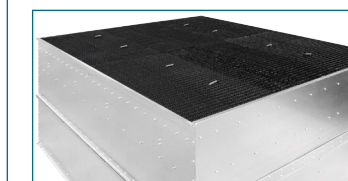

eco-LSWE and eco-LRWB  
Drift Eliminator



Drift Eliminators Removed  
for Coil Inspection



# Sage® Water and Energy Conservation Control System



Maximize the water or energy savings of your eco-cooler with EVAPCO's Sage® Water and Energy Conservation System! The Sage system automatically operates the eco unit in a manner which maximizes water or energy savings, based on the client's water or energy savings priority.

### Manufacturer Supplied and Programmed

Using our patented Sage Control System guarantees seamless integration with your eco unit, reduced field installation times, and maintains EVAPCO as your single-source cooling solution.

### Adaptive Control Sequence for Ultimate Savings

Many closed circuit coolers and cooling towers are operated year round in temperatures that drop below freezing. Often, remote sump tanks are utilized to keep the basin water from freezing by moving the spray water supply from the basin of the unit to a storage tank located indoors. By providing heat rejection through dry operation at temperatures above freezing, the eco-Coolers negate the need to add a remote sump tank to a project. Additionally, operating an eco-Cooler in the dry mode in freezing conditions eliminates common problems such as ice formation on fill media and air inlet louvers.

### Water Savings Priority

When set to prioritize water savings, the Sage control system automatically varies the unit between dry and evaporative modes of operation and stages spray pumps to minimize time spent in evaporative mode.

### Energy Savings Priority

When set to prioritize energy savings, the Sage control system automatically varies the unit between dry and evaporative modes of operation, and controls fan speed and pump operation in an effort to maximize energy savings.

### Enjoy the full benefits of the Sage control system with one of EVAPCO's unmatched hybrid cooling units

eco-AWTB & eco-ATWB-H evaporative coolers provide the ultimate solution for installations seeking the highest ambient dry bulb switchover temperatures, reduced water usage, high peak-load output, and plume abatement.



# Sage® Water and Energy Conservation Control System

### Programmable Logic Controller (PLC) communication protocols

- BACnet IP
- BACnet MS/TP
- Modbus RTU
- Modbus TCP

### Standard Control & Power Items

- UL Type 4 enclosure
- UL approval
- Programmable Logic Control
- Variable frequency drive(s)
- Recirculating pump motor starter(s)
- Fluid inlet/outlet temperature sensors with high and low alarm setpoints
- Basin temperature sensor(s)
- Ambient dry bulb sensor
- Main disconnect circuit breaker
- Main hand/off/auto switch (HOA)
- DC power supply for the PLC and instruments
- Control power transformer
- Heater contactor with overload protection and temperature setpoints with fusing
- 5-Probe Electronic Water Level Control package
- High/low water level alarm contacts
- Fan motor: space heater control(s)
- Relays for all PLC digital outputs
- Terminal blocks for each PLC input/output
- Ethernet connection between VFD(s), PLC and operator interface



### Control Features

- Manual operation of pumps and fans
- Ability to enable or disable makeup valve
- Power failure recovery timer
- Ability to perform bump test
- Visual status display of all unit components and accessories
- Back up with user settings and factory settings
- Pump runtime recorder
- Fan motor runtime recorder

### HMI Panel Display

All Sage<sup>2</sup> and Sage<sup>3</sup> Control Panels are provided with a 10" touch screen operator interface with a color display. This allows for easy viewing and control at the panel.



### Temperature Sensors (Field Installed)

Four separate temperature data points are monitored with this package:

- Inlet Temperature Sensor: 32°F – 212°F range
- Outlet Temperature Sensor: 32°F – 212°F range
- Dry-Bulb Temperature Sensor: -30°F – 130°F range
- Basin Temperature Sensor: 32°F – 212°F range

### Enclosure Temperature Control

The panel enclosure includes an intake and an exhaust ventilation fan. When the enclosure temperature rises to a predetermined setpoint, the exhaust fans are activated. The enclosure also contains a heater. The heater eliminates the drastic temperature changes which could create condensation inside of the enclosure. The ambient temperature range between -4°F to 104°F. Consult your EVAPCO sales representative for temperature requirements outside these conditions.



\*Optional communication protocol may be available. Please contact your local EVAPCO sales representative.



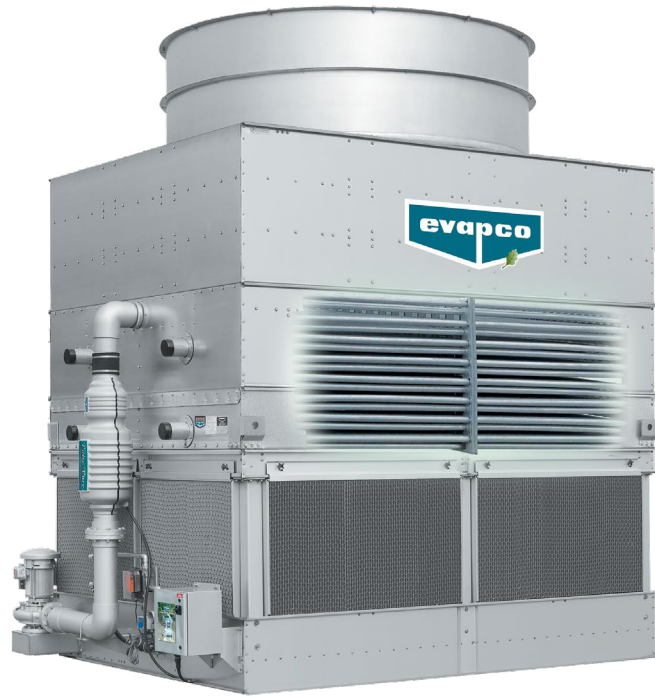

## Our Industry-Leading Approach

To enhance passivation and minimize the formation of *white rust*, we've developed a two-step process that produces visible results. Even in applications requiring immediate heat load, we can provide practical solutions for galvanized steel equipment.

The EVAPCO Pass-Protect® process is a combination of:

Step 1: Passiv-Assist® Factory Applied Pretreatment

Step 2: Field Passivation

Experience a custom passivation plan that promotes the formation of a passive oxide layer, eliminating the need to feed white rust inhibitors for the life of the unit.



Learn more about this solution at [evapco.com](http://evapco.com).



## Engineered to Improve Water Efficiency

The EVAPCO Water Saver™ utilizes capacitive deionization technology to reduce dissolved ion concentration, thus lowering the makeup water conductivity prior to use in an evaporative cooling system. Makeup water entering the Water Saver passes through individual cylinders which contain oppositely charged supercapacitors. Dissolved ions (except silica) are removed from the water as they are absorbed onto the charged capacitors. A typical 50% ion reduction allows the operating cycles of concentration to be safely doubled without an increase in scale or corrosion potential.



View the Water Saver video and Mechanical Specifications at [evapco.com](http://evapco.com) to learn more.



Pretreatment System for Evaporative Cooling Equipment



## Pulse-Pure® Non-Chemical Water Treatment System

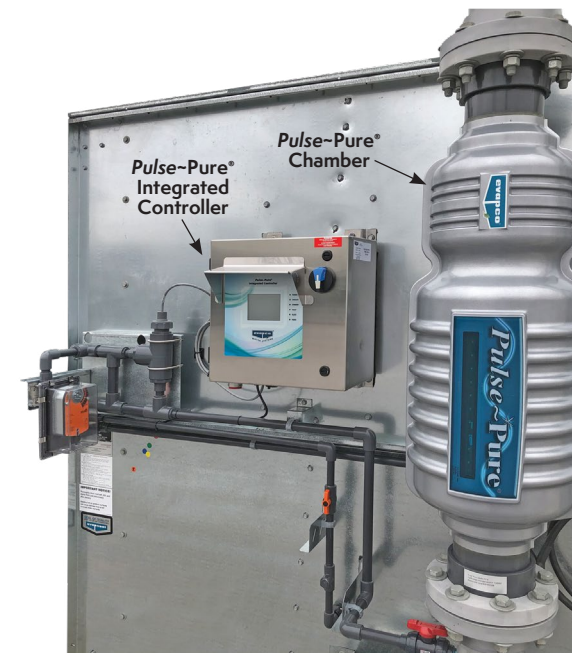

EVAPCO's *Pulse-Pure*® water treatment system utilizes pulsed electric field technology to provide an environmentally responsible alternative for the treatment of water in evaporative cooling equipment. The *Pulse-Pure*® system delivers short low- and high-frequency bursts of electromagnetic fields to the recirculating water in the fluid cooler.

- EVAPCO guarantees that total bacterial counts will not exceed 10,000 CFU/ml in the cooling water
- Controls scale, corrosion, and microbiological growth with absolutely no chemicals required
- Compact design with no moving parts and low energy consumption



Learn more about *Pulse-Pure*® at [evapco.com](http://evapco.com).



## Smart Shield® Solid Chemical Water Treatment System

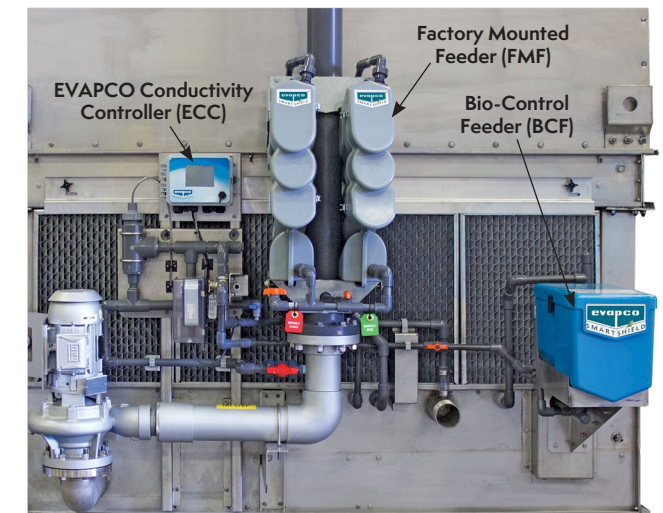

EVAPCO's *Smart Shield*® system utilizes proven solid chemistry delivered via our revolutionary feed system. With patented Controlled Release tablets, a scale and corrosion inhibitor is fed whenever your spray water pump is energized, keeping your system protected anytime the spray water pump is operating. *Smart Shield*® is a complete water treatment package that:

- Utilizes 'Bag in Bag' no touch chemical replenishments, making reloads easier and safer
- Creates reduced packaging, shipping and handling providing a reduced carbon footprint compared to liquid chemicals
- Eliminates the hazards associated with liquid chemicals, potential for liquid spills and the need for expensive feed pumps making it the easiest and safest chemical water treatment system available today



Watch a short product video at [evapco.com](http://evapco.com).



# Stainless Steel Material Options

All eco-LSWE and eco-LRWB Series units are constructed with galvanized steel panels as standard. The following pages illustrate the available stainless steel construction material options for this series. Stainless steel options are available in both 304 and 316L stainless steel. Selection of these options only changes the sheet steel; optional accessories such as attenuation, discharge hoods, platforms, etc. are available in stainless steel only by special order. Stainless steel discharge hoods/attenuation have galvanized dampers with a stainless steel linkage. Accessories, coils, and fan shafts **do not** change to stainless steel with these options and are upgraded separately. The strainer in the basin is always 304 stainless steel independent of basin construction.



## Stainless Steel Basin up to Overflow Level Option

Includes Type 304 stainless steel basin panels up to the overflow level. All panels above the overflow, including the fan discharge cowls are G-235 galvanized steel. Centrifugal fan wheels are **not available** in stainless steel.

This is the first stage of stainless steel on the LS Series units 5' wide and larger. The "stainless steel basin up to overflow" option is not available on 4' wide models



## Stainless Steel Water Touch Basin

All panels in the pan section in contact with the cooling water including the fan discharge cowls are constructed of Type 304 stainless steel. Remainder of unit constructed of G-235 galvanized steel. All models with this option are furnished with epoxy coated fan wheels and shafts coated with a rust inhibitor. Centrifugal fan wheels are **not available** in stainless steel.



## Stainless Steel Water Touch Unit

All panels in contact with the cooling water including the upper casing panels are constructed of Type 304 stainless steel. All models with this option are furnished with epoxy coated fan wheels and shafts coated with a rust inhibitor. Centrifugal fan wheels are **not available** in stainless steel.

This option designates the entire water section as stainless. Note that the fan housings and supports are still galvanized in this option.

**NOTE:** eco-LSWE models, with Ellipti-fin® and CROSSCOOL™, are only available with carbon steel coils which are hot dip galvanized after fabrication as standard.



## All Stainless Steel Except Fans Option

All panels including the fan housings and supports are constructed of Type 304 stainless steel. All models with this option are furnished with epoxy coated fan wheels and shafts coated with a rust inhibitor. Centrifugal fan wheels are **not available** in stainless steel. With this option, all sheet metal is stainless including the fan housings and supports.

**NOTE:** eco-LSWE models, with Ellipti-fin® and CROSSCOOL™, are only available with carbon steel coils which are hot dip galvanized after fabrication as standard.



## Stainless Steel Cold Water Basin

With this option, the lowest section of the unit, as highlighted in the photograph to the right, is constructed of Type 304 stainless steel. On all eco-LRWB units, the fan side inlet screens are PVC coated. Fan Screens are galvanized.

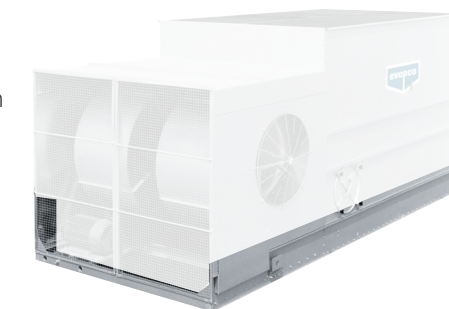

## Stainless Steel Water Touch Basin

All panels in the pan section in contact with the cooling water including the fan discharge cowls are constructed of Type 304 stainless steel. Remainder of unit constructed of G-235 galvanized steel. All models with this option are furnished with epoxy coated fan wheels and shafts coated with a rust inhibitor. Centrifugal fan wheels are **not available** in stainless steel. Fan Screens are galvanized.

**NOTE:** eco-LRWB models have carbon steel coils, which are hot dip galvanized after fabrication as standard.

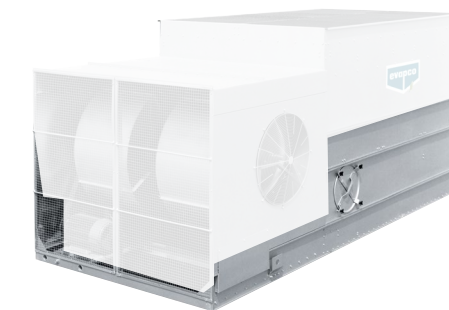

## Stainless Steel Water Touch Unit

All panels in contact with the cooling water including the upper casing panels are constructed of Type 304 stainless steel. All models with this option are furnished with epoxy coated fan wheels and shafts coated with a rust inhibitor. Centrifugal fan wheels are **not available** in stainless steel. Fan Screens are galvanized. This option designates the entire water section as stainless.

**NOTE:** eco-LRWB models, with Ellipti-fin® and CROSSCOOL™, are only available with carbon steel coils which are hot dip galvanized after fabrication as standard.

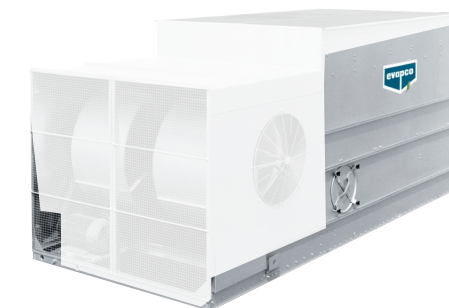

## All Stainless Steel Option (Excluding Fans/Coils)

All panels including the fan housings and supports are constructed of Type 304 stainless steel. All models with this option are furnished with epoxy coated fan wheels and shafts coated with a rust inhibitor. Centrifugal fan wheels are **not available** in stainless steel. With this option, all sheet metal is stainless including the Fan Housings and Supports. Fan Screens are stainless steel.

**NOTE:** eco-LRWB models, with Ellipti-fin® and CROSSCOOL™, are only available with carbon steel coils which are hot dip galvanized after fabrication as standard.

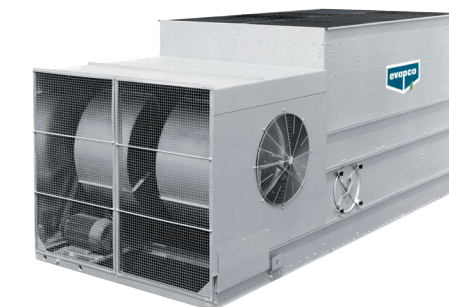



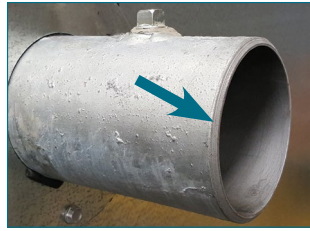

## Beveled For Weld (BFW) Coil Connections

EVAPCO closed circuit coolers are provided with beveled for weld (BFW) coil connections as standard. Beveled edges simplify field welding and allow welds to fully penetrate.



## Optional Factory Mounted Crossover Piping

Some EVAPCO closed circuit coolers are design for "series flow" coil operation where the coils inside of one cell are operated in series. These units are denoted by a "-Z" following the unit model number. These units require "crossover piping" from one coil to the other. As an option, this piping can be installed in the factory for simplified field installation.



## Optional Grooved Coil Connections

Grooved connections can be provided as an optional coil connection. The groove allows for a mechanical coupling allowing for faster and easier field piping.

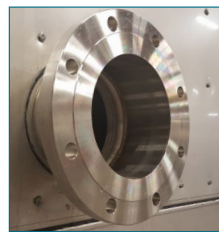

## Optional Flanged Coil Connections

150# raised faced flanged connections can be provided as an optional coil connection. The flanged coil connection allows for faster and easier field piping to a mating flanged connection. 300# flanged can be provided in some cases. Please see your local EVAPCO sales representative.

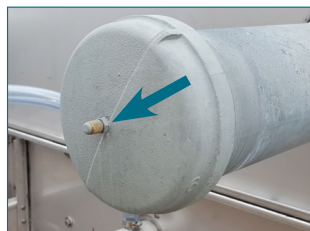

## Optional Nitrogen Charged Coils

For projects requiring long term storage or ocean freight, coils can be nitrogen charged at the factory to prevent corrosion inside of the coil circuits.

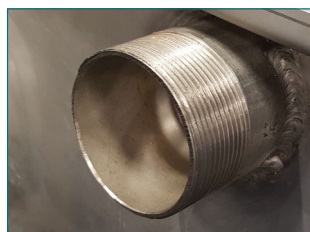

## Optional Male Pipe Thread (MPT) Coil Connections

Male pipe thread (MPT) connections can be provided as an optional connection for mating with female pipe thread (FPT) piping.

**NOTE:** All coil connections are constructed from the same material as the coil.

## Sound Attenuation Packages

The centrifugal fan design of the eco-LSWE and LRWB models operate at lower sound levels which make these units preferable for installations where noise is a concern. For sound-sensitive applications, the eco-LSWE and eco-LRWB centrifugal fan models may be supplied with various stages of intake and/or discharge attenuation packages which further reduce sound levels.

Consult the factory for certified sound data for each sound attenuation option.

**NOTE:** Sound attenuation packages may require oversized fan motors.

## Fan Side Inlet Attenuation (eco-LRWB Only)

Reduces sound radiated from the fan side air intakes and has an open side to allow for air entry. **This attenuation package ships loose to be mounted in the field on each side of the closed circuit cooler over the fan intakes.**

## Fan End Inlet Attenuation

Reduces sound radiated through the end air intakes. It consists of baffled panels that change the path of the air entry and capture the radiated noise thus reducing the overall sound levels generated. In addition, the external belt adjustment mechanism is extended through the inlet attenuator to allow for easy adjustment without having to enter the unit. Solid bottom panels are included with this option to force the inlet air through the attenuator.

## Discharge Attenuation

The discharge attenuation hood features a straight-sided design with insulated baffles to reduce the overall sound levels of the discharge air. The discharge attenuation incorporates a large access panel to allow entry to the drift eliminators and water distribution system. **If a higher discharge velocity is required with minimal sound attenuation, a tapered discharge hood is available.**

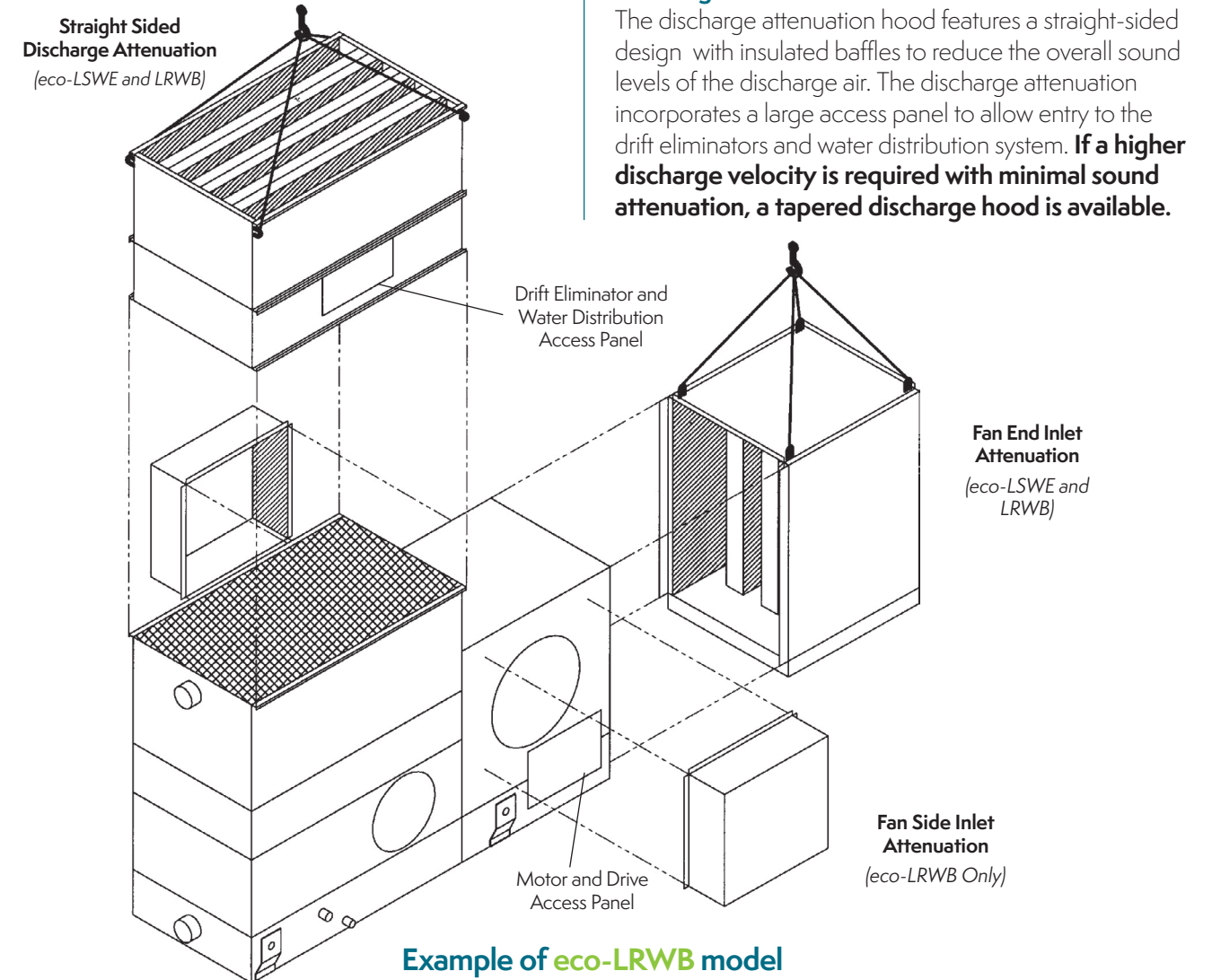



# eco-LSWE Discharge & Intake Attenuation

## eco-LSWE Discharge Attenuation Dimensions\*

Unit Footprint	H1 (in.)	L1 (in.)	W1 (in.)	Weight per Attenu.	No. of Attenu.
4' x 6'	47	71-7/8	45-1/2	565	1
4' x 9'	47	107-1/4	45-1/2	745	1
4' x 12'	47	143-1/2	45-1/2	1000	1
4' x 18'	47	216	45-1/2	1370	1
5' x 12'	47	143-1/2	61-7/8	1215	1
5' x 18'	47	216	61-7/8	1660	1
8P' x 12'	71-3/8	143-3/4	92-1/4	2290	1
8P' x 18'	71-3/8	216	92-1/4	3120	1
8P' x 24'	71-3/8	143-3/4	92-1/4	2290	2
8P' x 36'	71-3/8	216	92-1/4	3120	2
10' x 12'	71-3/8	143-1/2	119	2715	1
10' x 18'	71-3/8	216	119	3680	1
10' x 24'	71-3/8	143-1/2	119	2715	2
10' x 36'	71-3/8	216	119	3680	2

## eco-LSWE Intake Attenuation Dimensions\*

Unit Footprint	H2 (in.)	L2 (in.)	Compact Weight (lb.)	Basic Weight (lb.)	Extended Weight (lb.)	No. of Attenu.
4' x 6'	39-3/4	74-5/8	610	760	980	1
4' x 9'	39-3/4	111	870	1070	1350	1
4' x 12'	39-3/4	147-1/4	1120	1360	1710	1
4' x 18'	39-3/4	219-3/4	1750	2060	2520	1
5' x 12'	46-1/4	147-1/4	1380	1570	1850	1
5' x 18'	46-1/4	219-3/4	2130	2370	2720	1
8P' x 12'	81-1/2	147-3/8	1820	2130	2590	1
8P' x 18'	81-1/2	219-3/4	2770	3180	3780	1
8P' x 24'	81-1/2	145-3/8	1820	2115	2555	2
8P' x 36'	81-1/2	217-7/8	2805	3175	3740	2
10' x 12'	89	147-1/2	2020	2330	2780	1
10' x 18'	89	220	2750	3270	4050	1
10' x 24'	89	145-1/2	2030	2320	2745	2
10' x 36'	89	218-1/8	3140	3490	4015	2

\* Attenuation dimensions may vary slightly from catalog. See factory certified prints for exact dimensions.

NOTE: Weights provided in the tables above are per attenuator.

### eco-LSWE Attenuation

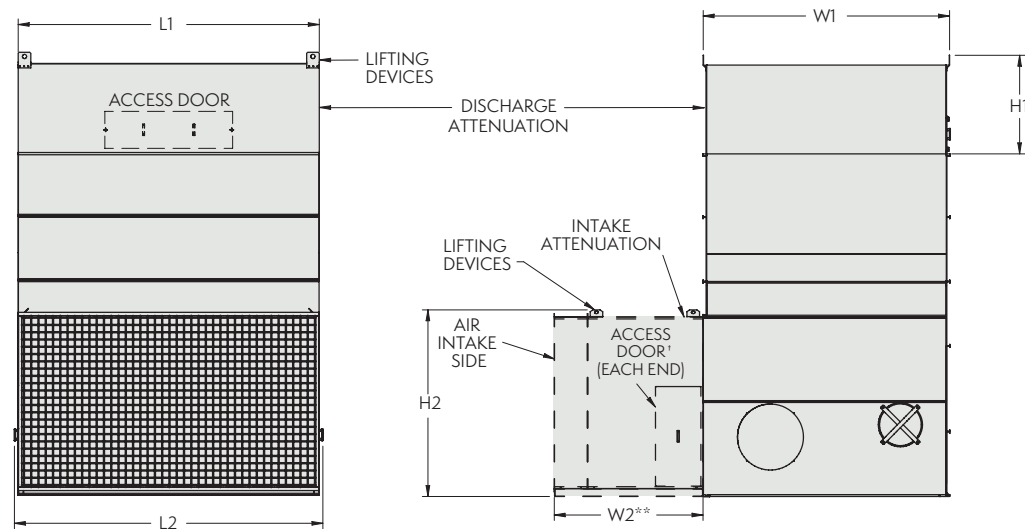

\*\* Measurements for W2 will vary based on selected attenuation (Compact, Basic, or Extended).

† Please note the Compact option has NO access door.

NOTE: Intake sound attenuation must be fully supported. If the recommended steel support is being used a third I-beam is required for the intake attenuation. Refer to page 22.

NOTE: Sound attenuation packages may require oversized fan motors.

W2 Variations (in.)	
Compact	45
Basic	55-1/2
Extended	71-3/8

# eco-LRWB Discharge & Intake Attenuation

## eco-LRWB Discharge Attenuation Dimensions\*

Coil Casing Footprint	H1 (in.)	L1 (in.)	W1 (in.)	Weight per (in.)	Number of Attenuator
3' x 6'	43-3/8"	71-3/4"	40-1/2"	670	1
5' x 6'	43-3/8"	71-1/4"	60-5/8"	850	1
5' x 9'	43-3/8"	107-1/4"	60-5/8"	1,170	1
5' x 12'	43-3/8"	143-5/8"	60-5/8"	1,990	1
8' x 9'	43-3/8"	107-1/4"	94"	1,570	1
8' x 12'	43-3/8"	143-5/8"	94"	2,030	1

## eco-LRWB Fan End Attenuation Dimensions\*

Coil Casing Footprint	H2 (in.)	W2 (in.)	L2 (in.)	Weight per (in.)	Number of Attenuator
3' x 6'	63-7/8"	40-1/2"	43-5/8"	810	1
5' x 6'	79-5/8"	60-5/8"	43-1/2"	1280	1
5' x 9'	79-5/8"	60-5/8"	43-1/2"	1280	1
5' x 12'	79-5/8"	60-5/8"	43-1/2"	1280	1
8' x 9'	79-5/8"	94-1/4"	43-5/8"	1530	1
8' x 12'	79-5/8"	94-1/4"	43-5/8"	1530	1

## eco-LRWB Fan Side Attenuation Dimensions\*

Coil Casing Footprint	H3 (in.)	W3 (in.)	L3 (in.)	Weight per (in.)	Number of Attenuator
3' x 6'	33-5/8"	64-3/4"	34-3/4"	60	2
5' x 6'	36-7/8"	84-7/8"	54"	60	2
5' x 9'	36-7/8"	84-7/8"	54"	60	2
5' x 12'	36-7/8"	84-7/8"	54"	60	2
8' x 9'	42-3/8"	118-1/2"	44-1/8"	60	2
8' x 12'	42-3/8"	118-1/2"	44-1/8"	60	2

\* Attenuation dimensions may vary slightly from catalog. See factory certified prints for exact dimensions.

### eco-LRWB Attenuation

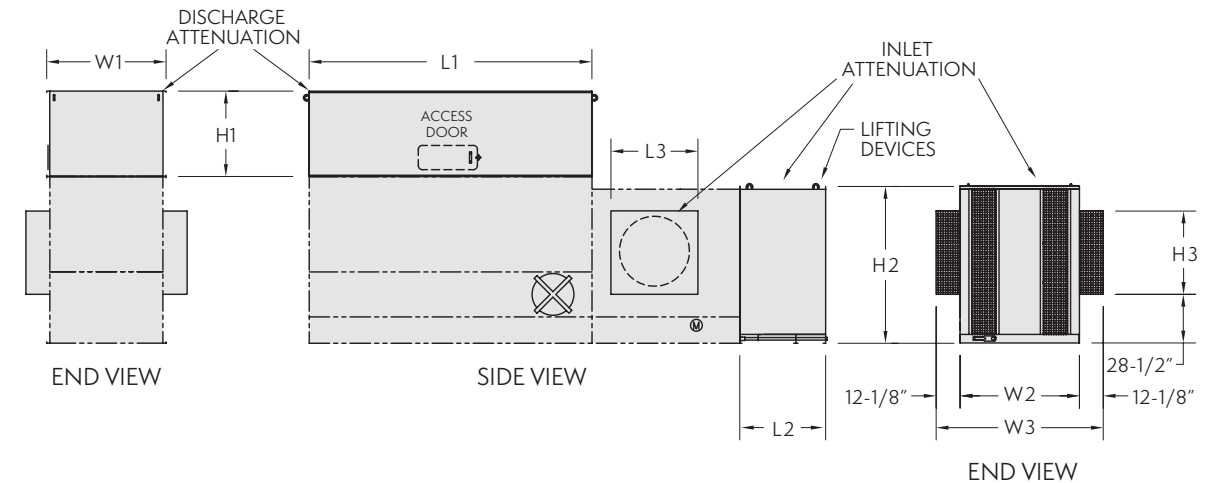

NOTE: Intake sound attenuation must be fully supported. If the recommended steel support is being used, extended I-beams are required for the intake attenuation. Refer to page 24.

NOTE: Sound attenuation packages may require oversized fan motors.

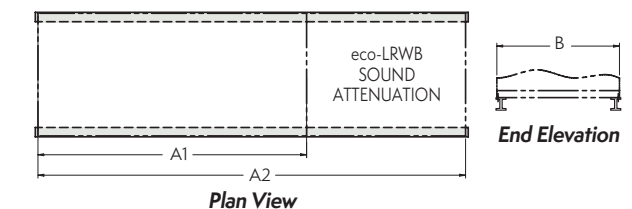



# Freeze Protection & Heat Loss

## Freeze Protection

If the units are installed in a cold climate and operated year-round, freeze protection must be provided for the heat exchanger coil in the unit as well as for the recirculating water system.

## Recirculating Water System Freeze Protection Options

### Remote Sump Configuration

The surest way to protect the recirculating water system from freezing is with a remote sump. The remote sump should be located inside the building and below the unit. **When a remote sump arrangement is selected, the spray pump is provided by others and installed at the remote sump.** All water in the closed circuit cooler basin should drain to the remote sump when the spray pump cycles off.

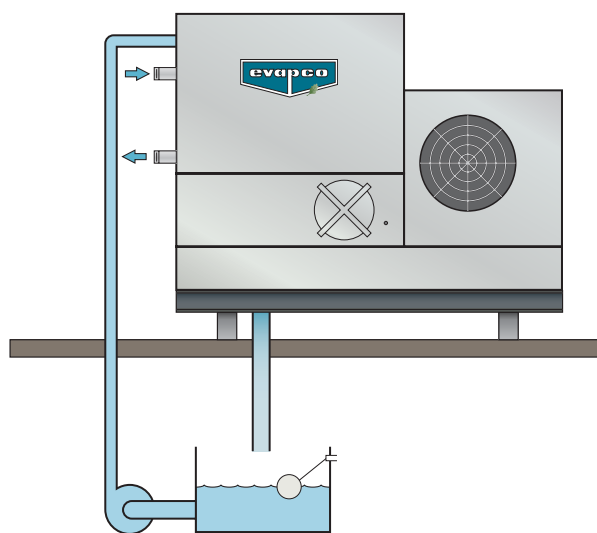

### Steam/Hot Water Coils

Steam or hot water coils are available as an alternative to using electric basin heaters or a remote sump. Constructed of galvanized pipe, the coils are installed in the closed circuit cooler basin, and are ready for piping to an external hot water source. **Controls for steam/hot water coils are provided by others and should be interlocked with the water circulating pump to prevent their operation when the pump is energized.**

## Basin Heater Package

If a remote sump configuration is not practical, electric basin heater packages are available to keep the pan water from freezing when the unit cycles off. Water lines to and from the unit, spray pump and related piping should be heat traced and insulated up to the overflow level to protect from freezing. **Basin heaters should be interlocked with the water circulating pump to prevent their operation when the pump is energized.**

This unit should not be operated dry (fans on, pump off) unless the basin is completely drained or the heaters have been oversized and the unit has been designed for dry operation. Consult the factory when dry operation is a requirement.

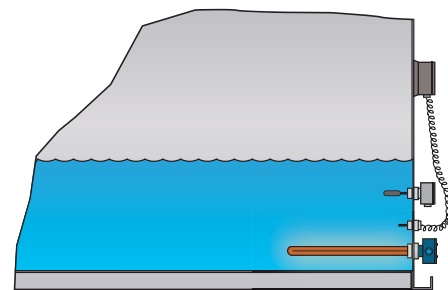

## eco-LSWE Basin Heater Sizing

Unit Footprint	Minimum Flow for Freeze		
	Standard Unit	Series Flow Unit (-Z)	
4' x 6'	(1) 2	(1) 3	(1) 4
4' x 9'	(1) 3	(1) 4	(1) 5
4' x 12'	(1) 3	(1) 5	(1) 7
4' x 18'	(1) 5	(1) 7	(1) 9
5' x 12'	(1) 4	(1) 6	(1) 8
5' x 18'	(2) 3	(2) 4	(1) 12
8P' x 12'	(1) 5	(1) 8	(1) 10
8P' x 18'	(2) 4	(2) 6	(2) 7
8P' x 24'	(2) 5	(2) 7	(2) 10
8P' x 36'	(2) 7	(2) 12	(2) 15
10' x 12'	(1) 7	(1) 10	(1) 15
10' x 18'	(2) 5	(2) 7	(2) 10
10' x 24'	(2) 7	(2) 10	(2) 15
10' x 36'	(2) 10	(4) 7	(4) 9

## eco-LRWB Basin Heater Sizing

Unit Footprint	Minimum Flow for Freeze		
	Standard Unit	Series Flow Unit (-Z)	
3' x 6'	(1) 2	(1) 3	(1) 4
5' x 6'	(1) 3	(1) 5	(1) 6
5' x 9'	(1) 4	(1) 6	(1) 8
5' x 12'	(1) 6	(1) 8	(1) 12
8' x 9'	(1) 7	(1) 9	(1) 12
8' x 12'	(1) 9	(1) 12	(1) 16

## Heat Exchanger Coil Freeze Protection Options

The simplest and most foolproof method of protecting the heat exchanger coil from freeze-up is to use a glycol solution. If this is not possible, an auxiliary heat load must be maintained on the coil at all times so that the water temperature does not drop below 50°F when the cooler is shut down and, a minimum recommended flow rate per unit as shown in the table below must be maintained. Refer to Heat Loss Data Table on page 23 for heat loss data.

## eco-LSWE Minimum Flows for Freeze Protection

Unit Footprint	Minimum Flow for Freeze	
	Standard Unit	Series Flow Unit (-Z)
4' x 6'	66	33
4' x 9'	66	33
4' x 12'	66	33
4' x 18'	66	33
5' x 12'	94	47
5' x 18'	94	47
8P' x 12'	148	74
8P' x 18'	148	74
8P' x 24'	296	148
8P' x 36'	296	148
10' x 12'	188	94
10' x 18'	188	94
10' x 24'	376	188
10' x 36'	376	188

## eco-LRWB Minimum Flows for Freeze Protection

Coil Casing Footprint	Minimum Flow for Freeze	
	Standard Unit	Series Flow Unit (-Z)
3' x 6'	60	30
5' x 6'	94	47
5' x 9'	94	47
5' x 12'	94	47
8' x 9'	148	74
8' x 12'	148	74

If an anti-freeze solution is not used, the coil must be drained immediately whenever the pump is shut down or flow stops. Care must be taken to ensure that the piping is sized to allow the water to flow quickly from the coil. This method of freeze control should only be used in an emergency situation. Coils should not be drained for an extended period of time. Leaving the coil drained and open to the atmosphere can cause corrosion inside the tubes which may lead to premature coil failure.

The amount of glycol required for a system will depend upon the total volume of water in the closed loop and the winter ambient conditions for the installation. The engineering data tables presented on pages 27-43 provide the water volume contained inside the cooler coils to assist in this calculation.

## Discharge Hoods with Positive Closure Dampers

When a closed circuit cooler is used in a water-to-air heat pump system or in certain process cooling applications, a method of reducing the heat loss during idle periods of wintertime operation may be required. **For these cases, an optional discharge hood with positive closure dampers and damper actuator is available.**

The discharge hood with dampers is designed to minimize the heat loss from convective airflow through an idle cooler. Further reductions in heat loss may be obtained with the addition of insulation to the hood and casing, minimizing conductive heat losses. **Optional insulation may be factory-installed on the hood and casing or field-installed by an insulation contractor.**

The discharge hood and dampers are constructed of hot-dip galvanized steel as standard. Hoods are equipped with access panels to facilitate maintenance on the eliminators and water distribution system. The dampers, damper actuator and linkage are all factory-assembled. **Actuator controls and wiring are field-supplied by others. Damper actuators require 120 volt power supply. Stainless steel discharge hoods with galvanized positive closure dampers are available as an optional accessory.**

The system control sequence should provide for dampers to be fully open before the fans are running and closed when the fans are off; the damper actuator must be interlocked with the temperature control system for this purpose. **When a tapered discharge hood is specified, the next larger size fan motor must be used to overcome the additional static pressure.**

Heat loss data is provided for standard units without hoods, with hoods and with hoods and insulation. Table ratings are based on 50°F water in the coil, -10°F ambient and 45 MPH winds (fan and pump off).

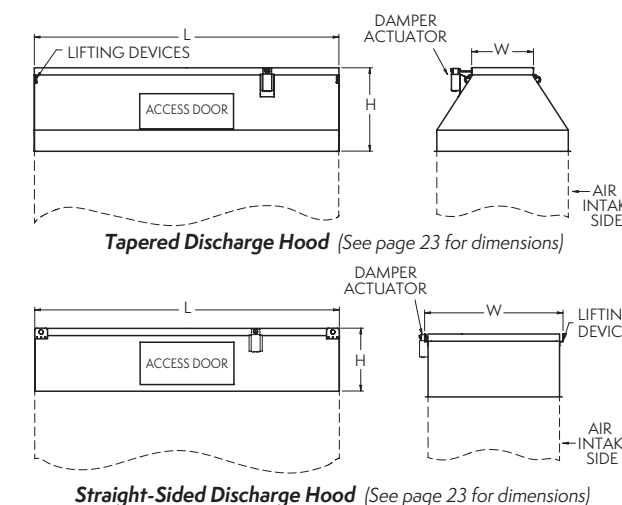



## Heat Loss

eco-LSWE Heat Loss Data

LSWE Model	Standard Unit (MRH)	Unit with Hood (MRH)	With Hood & Insulation
4-2x6	37	29	19
4-3x6	50	33	21
4-4x6	61	36	23
4-5x6	68	39	25
4-3x9	76	44	28
4-4x9	92	48	31
4-5x9	104	52	33
4-3x12	103	54	35
4-4x12	124	60	38
4-5x12	140	65	42
4-3x18	155	76	49
4-4x18	188	84	54
4-5x18	211	91	58
5-3x12	147	70	45
5-4x12	178	77	49
5-5x12	200	83	53
5-6x12	213	90	57
5-7x12	231	98	62
5-3x18	223	96	62
5-4x18	269	105	67
5-5x18	303	114	73
5-6x18	322	123	79
5-7x18	349	134	86
8-3x12	227	98	63
8-4x12	276	105	67
8-5x12	309	112	72
8-6x12	329	119	76
8-3x18	311	132	85
8-4x18	376	141	90
8-5x18	468	150	96
8-6x18	499	159	102
8-7x18	541	173	111

eco-LRWB Heat Loss Data

LRWB Model	Standard Unit (MRH)	Unit with Hood (MRH)	With Hood & Insulation
3-2x6	33	29	22
3-3x6	46	36	23
3-4x6	54	39	25
3-5x6	62	42	27
5-2x6	52	44	29
5-3x6	72	45	30
5-4x6	87	49	31
5-5x6	98	53	34
5-3x9	110	59	38
5-4x9	133	64	41
5-5x9	149	69	44
5-6x9	159	73	47
5-7x9	162	86	55
5-3x12	147	74	47
5-4x12	178	80	51
5-5x12	200	85	55
5-6x12	213	91	59
5-7x12	217	107	68
8-3x9	170	77	49
8-4x9	205	83	53
8-5x9	231	89	57
8-6x9	246	94	61
8-7x9	250	110	71
8-3x12	228	94	60
8-4x12	276	101	64
8-5x12	310	107	69
8-6x12	330	114	73
8-7x12	336	133	85

## Discharge Hood Dimensions

eco-LSWE Tapered Discharge Hood Dimensions

Unit Footprint	H (in.)	L (in.)	W (in.)	Weight per Hood (lbs.)	# of Hoods
4' x 6'	33	71-7/8	21-1/8	205	1
4' x 9'	33	107-1/4	21-1/8	275	1
4' x 12'	33	143-1/2	21-1/8	350	1
4' x 18'	33	216	21-1/8	485	1
5' x 12'	39-1/2	143-1/2	29-1/8	450	1
5' x 18'	39-1/2	216	29-1/8	615	1
8P' x 12'	42-5/8	143-3/4	45-5/8	615	1
8P' x 18'	42-5/8	216	45-5/8	835	1
8P' x 24'	42-5/8	143-3/4	45-5/8	1,230	2
8P' x 36'	42-5/8	216	45-5/8	1,670	2
10' x 12'	50-3/8	143-5/8	58-1/8	775	1
10' x 18'	50-3/8	216	58-1/8	1,055	1
10' x 24'	50-3/8	143-5/8	58-1/8	1,550	2
10' x 36'	50-3/8	216	58-1/8	2,110	2

eco-LRWB Tapered Discharge Hood Dimensions

Coil Casing Footprint	H (in.)	L (in.)	W (in.)	Weight per Hood (lbs.)	# of Hoods
3' x 6'	24-1/2	71-7/8	19	235	1
5' x 6'	39-1/4	71-7/8	29	390	1
5' x 9'	39-1/4	107-1/4	29	520	1
5' x 12'	39-1/4	143-5/8	29	680	1
8' x 9'	42-1/2	107-1/4	42-1/2	785	1
8' x 12'	42-1/2	143-5/8	42-1/2	975	1

eco-LSWE Straight-Sided Discharge Hood Dimensions

Unit Footprint	H (in.)	L (in.)	W (in.)	Weight per Hood (lbs.)	# of Hoods
4' x 6'	30	71-7/8	45-1/2	180	1
4' x 9'	30	107-1/4	45-1/2	250	1
4' x 12'	30	143-1/2	45-1/2	300	1
4' x 18'	30	216	45-1/2	395	1
5' x 12'	30	143-1/2	62	330	1
5' x 18'	30	216	62	495	1
8P' x 12'	30	143-3/4	95-1/2	450	1
8P' x 18'	30	216	95-1/2	615	1
8P' x 24'	30	143-3/4	95-1/2	900	2
8P' x 36'	30	216	95-1/2	1,230	2
10' x 12'	30	143-5/8	119-1/8	625	1
10' x 18'	30	216-1/4	119-1/8	855	1
10' x 24'	30	143-5/8	119-1/8	1,250	2
10' x 36'	30	216-1/4	119-1/8	1,710	2

eco-LRWB Straight-Sided Discharge Hood Dimensions

Coil Casing Footprint	H (in.)	L (in.)	W (in.)	Weight per Hood (lbs.)	# of Hoods
3' x 6'	29-1/2	71-7/8	40-1/2	370	1
5' x 6'	29-1/2	71-7/8	60-5/8	470	1
5' x 9'	29-1/2	107-1/4	60-5/8	680	1
5' x 12'	29-1/2	143-5/8	60-5/8	860	1
8' x 9'	29-1/2	107-1/4	94	985	1
8' x 12'	29-1/2	143-5/8	94	1,245	1

## Steel Support

The recommended support for EVAPCO Closed Circuit Coolers is structural I-beams located under the outer flanges and running the entire length of the unit. Mounting holes 3/4" in diameter are located in the bottom channels of the pan section to provide for bolting to the structural steel. (Refer to certified drawings from the factory for bolt hole locations.)

Beams should be level to within 1/360 of unit length, not to exceed 1/2" before setting the unit in place. Do not level the unit by shimming between it and the I-beams as this will not provide proper longitudinal support.

eco-LRWB Dimensions

Coil Casing Footprint	A1 (Unit Only)	A2 (Unit with Intake Atten.)	B
3' x 6'	10' 1-7/8"	13' 9-5/8"	3' 4-1/2"
5' x 6'	12' 2-7/8"	15' 10-5/8"	5' 5/8"
5' x 9'	15' 2-1/4"	18' 10"	5' 5/8"
5' x 12'	18' 2-5/8"	21' 10-3/8"	5' 5/8"
8' x 9'	15' 2-1/4"	18' 10"	7' 10"
8' x 12'	18' 2-5/8"	21' 10-3/8"	7' 10"

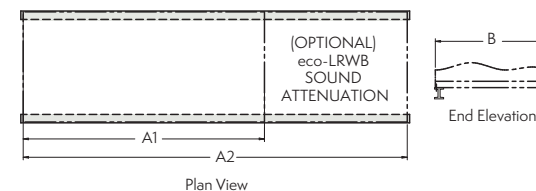

eco-LSWE Dimensions

Coil Casing Footprint	B1 (Unit Only)	B2 (Compact Option)	B3 (Basic Option)	B4 (Extended Option)	A
4' x 6'	4' 5/8"	7' 9-5/8"	8' 8-1/4"	10'	5' 11-7/8"
4' x 9'	4' 5/8"	7' 9-5/8"	8' 8-1/4"	10'	8' 11-1/4"
4' x 12'	4' 5/8"	7' 9-5/8"	8' 8-1/4"	10'	11' 11-1/2"
4' x 18'	4' 5/8"	7' 9-5/8"	8' 8-1/4"	10'	18'
5' x 12'	5' 5"	9' 2"	10' 5/8"	11' 3-15/16"	11' 11-1/2"
5' x 18'	5' 5"	9' 2"	10' 5/8"	11' 3-15/16"	17' 11-7/8"
8P' x 12'	7' 10"	11' 7"	12' 5-5/8"	13' 8-7/8"	11' 11-3/4"
8P' x 18'	7' 10"	11' 7"	12' 5-5/8"	13' 8-7/8"	18'
8P' x 24'	7' 10"	11' 7"	12' 5-5/8"	13' 8-7/8"	24' 1"
8P' x 36'	7' 10"	11' 7"	12' 5-5/8"	13' 8-7/8"	36' 1-1/2"
10' x 12'	9' 9-3/4"	13' 6-3/4"	14' 5-3/8"	15' 8-5/8"	11' 11-3/4"
10' x 18'	9' 9-3/4"	13' 6-3/4"	14' 5-3/8"	15' 8-5/8"	18' 1/4"
10' x 24'	9' 9-3/4"	13' 6-3/4"	14' 5-3/8"	15' 8-5/8"	24' 1-1/8"
10' x 36'	9' 9-3/4"	13' 6-3/4"	14' 5-3/8"	15' 8-5/8"	36' 2-1/8"

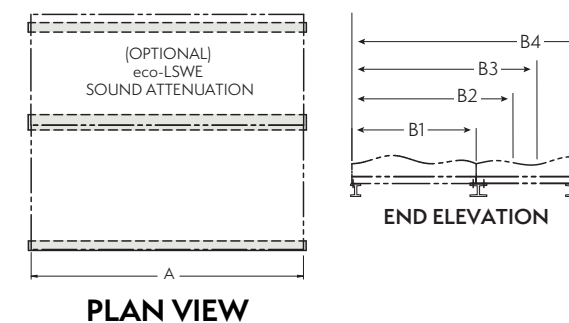

## Optional Equipment

### Electric Water Level Control

Closed Circuit Coolers may be ordered with an electric water level control in lieu of the standard mechanical float and make-up assembly. This package provides accurate control of water levels and does not require field adjustment.



the roof or at ground level. It is recommended that bottom screens be added to the unit when it will be elevated. These screens can be provided by the factory at an additional cost or added by the installing contractor.

### Solid Bottom Panels for Ducted Installations

When centrifugal fan units are installed indoors and intake air is ducted to the unit, a solid bottom panel is required to completely enclose the fan section and prevent the unit from drawing air from the room into the fan intakes. When this option is ordered, air inlet screens are omitted and the next larger size fan motor must be used to overcome the additional static pressure.

### Bottom Screens

Protective inlet screens are provided on the sides and/or end of the unit's air intake. Screens are not provided below the fan section since most units are mounted on



## eco-LRWB Reduced Height and Maintenance Accessibility

The eco-LRWB has been designed to satisfy installation requirements where height limits must be observed. The lower profile design of the eco-LRWB does not, however, sacrifice maintenance accessibility for reduced height. Its unique casing design allows the water distribution system, cold water basin, fan section and other unit components to be easily maintained.

Small, light-weight sections of the drift eliminators can be easily removed to access the water distribution system. A large circular access door is located on the side of the cold water basin to allow adjustment of the float assembly, removal of the stainless steel strainers and cleaning of the basin. The fan motor and drive system are located at one end of the unit and are completely accessible by removing the inlet screens. Routine bearing lubrication and belt tensioning can be performed from the exterior of the unit without removing the inlet screens.

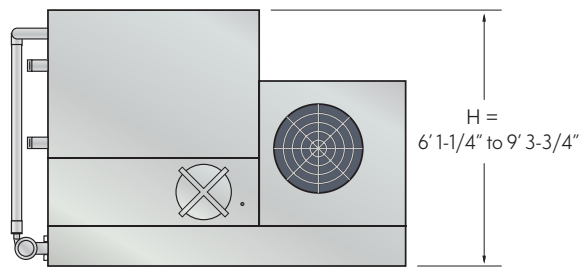

## Low Installed Costs

The compact, unitary design of the eco-LRWB closed circuit cooler allows it to be shipped completely assembled. This results in lower transportation costs and no assembly requirements at the job site.

**NOTE:** Options such as sound attenuation and discharge hoods will require additional lifts and some minor assembly.

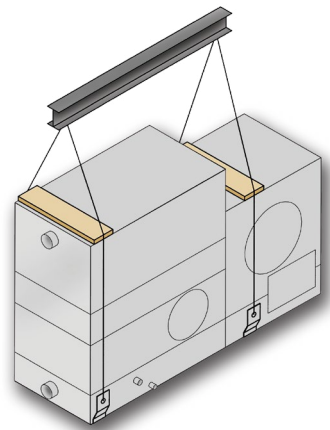

## Transport of a Pre-Assembled Unit

Since the eco-LRWB ships fully assembled, it is ideal for truck-mounted applications, for remote sites or temporary installations.

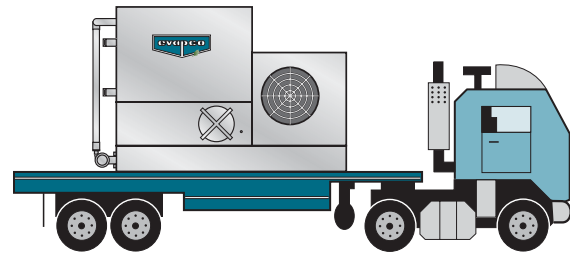

## Stainless Steel Cold Water Basin

Stainless steel cold water basins are optional on the eco-LRWB. Additional upgrades to stainless steel water touch basins, stainless steel water touch units and all stainless steel construction are also available. For more information on stainless steel construction options, see pages 15 and 16 of this catalog.



## Integral Fan Enclosure for Lower Sound

The eco-LRWB comes standard with an integral fan enclosure that reduces sound levels by 2 dB. This 3-sided enclosure also protects the fan and drive system for longer equipment life.



## Design

EVAPCO closed circuit coolers are of heavy-duty construction and designed for long trouble-free operation. Proper equipment selection, installation and maintenance is, however, necessary to ensure full unit performance. Some of the major considerations in the application of a cooler are presented below. For additional information, contact the factory.

## Air Circulation

It is important that proper air circulation be provided. The best location is on an unobstructed roof top or on ground level away from walls and other barriers. Those closed circuit coolers located in wells, enclosures or adjacent to high walls must be properly located to avoid the problems associated with recirculation.

Recirculation raises the wet bulb temperature of the entering air causing the water temperature to rise above the design. For these cases, the discharge of the unit should be located at a height even with the adjacent wall, thereby reducing the chance of recirculation. For additional information, see the EVAPCO equipment layout manual.

Good engineering practice dictates that the closed circuit cooler discharge air not be directed or located close to or in the vicinity of building air intakes.

## Piping

Cooler piping should be designed and installed in accordance with generally accepted engineering practices. The piping layout should be symmetrical on multiple unit systems, and sized for a reasonably low water velocity and pressure drop.

The standard closed circuit cooler is recommended only on a closed, pressurized system. The piping system should include an expansion tank to allow for fluid expansion and purging air from the system.

**NOTE:** Closed circuit coolers should never be used on an open type system. An open type system with a cooler may result in premature coil failure.

The piping system should be designed to permit complete drainage of the heat exchanger coil. This will require a vacuum breaker or air vent to be installed at the high point and a drain valve installed at the low point of the piping system. Both must be adequately sized.

All piping should be securely anchored by properly designed hangers and supports. No external loads should be placed

upon the cooler connections, nor should any of the pipe supports be anchored to the cooler framework.

## Recirculating Water Quality

Proper water treatment is an essential part of the maintenance required for evaporative cooling equipment. A well designed and consistently implemented water treatment program will help to ensure efficient system operation while maximizing the equipment's service life. **If EVAPCO factory mounted water systems are not utilized**, a qualified water treatment company should design a site specific water treatment protocol based on equipment (including all metallurgies in the cooling system), location, makeup water quality, and usage.

## Bleed off

Evaporative cooling equipment requires a bleed or blowdown line, located on the discharge side of the recirculating pump, to remove concentrated (cycled up) water from the system. EVAPCO recommends an automated conductivity controller to maximize the water efficiency of your system. **If EVAPCO factory mounted water systems are not utilized**, based on recommendations from your water treatment company, the conductivity controller should open and close a motorized ball or solenoid valve to maintain the conductivity of the recirculating water. If a manual valve is used to control the rate of bleed it should be set to maintain the conductivity of the recirculating water during periods of peak load at the maximum level recommended by your water treatment company.

## Water Treatment

The water treatment program prescribed for the given conditions must be compatible with the unit's materials of construction, including any galvanized components. The initial commissioning and passivation period is a critical time for maximizing the service life of galvanized equipment. EVAPCO recommends that the site specific water treatment protocol includes a passivation procedure which details water chemistry, any necessary chemical addition, and visual inspections during the first six (6) to twelve (12) weeks of operation. During this passivation period, recirculating water pH should be maintained above 7.0 and below 8.0 at all times. Batch feeding of chemicals is not recommended.

## Control of Biological Contaminants

Evaporative cooling equipment should be inspected regularly to ensure good microbiological control. Inspections should include both monitoring of microbial populations via culturing techniques and visual inspections for evidence of biofouling.

Poor microbiological control can result in loss of heat transfer efficiency, increase corrosion potential, and increase the risk of pathogens such as those that cause Legionnaires' disease. Your site specific water treatment protocol should include procedures for routine operation, startup after a shut-down period, and system lay-up, if applicable. If excessive microbiological contamination is detected, a more aggressive mechanical cleaning and/or water treatment program should be undertaken.



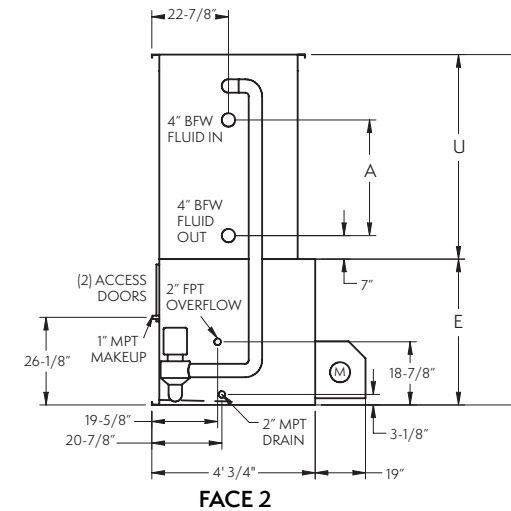
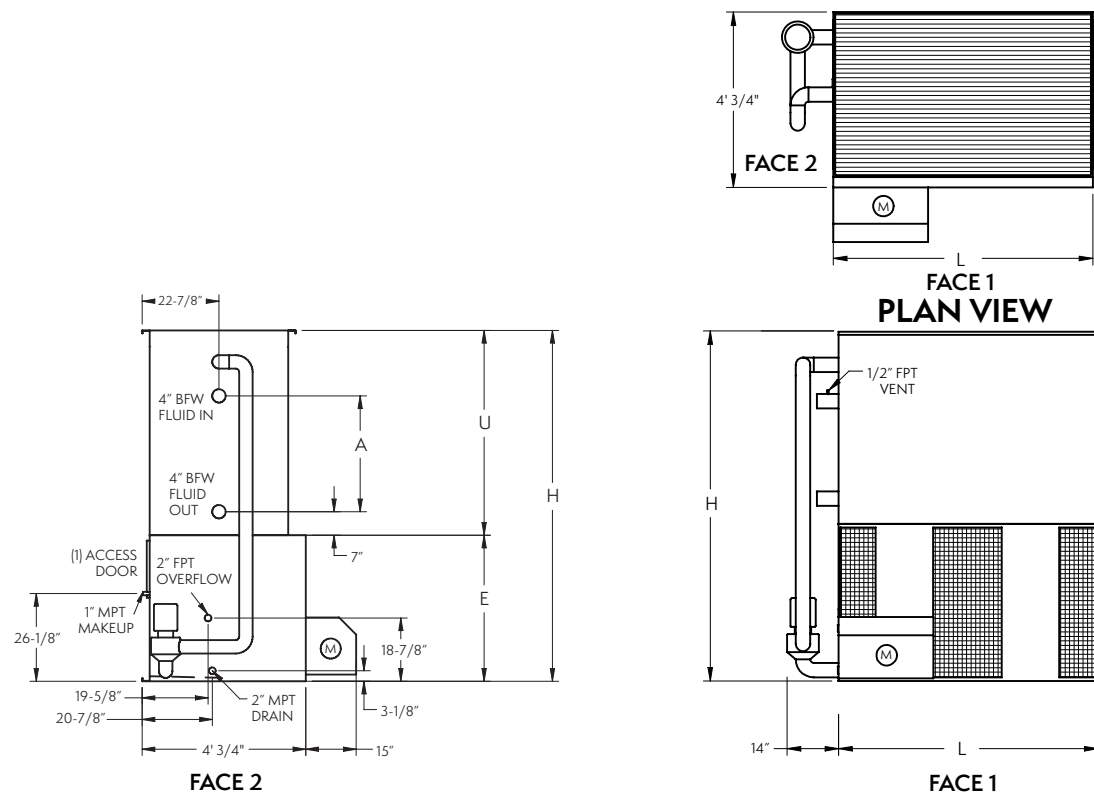

Model No. †	WEIGHTS (LBS)			FANS		SPRAY PUMP		Coil Volume (Gallons)	REMOTE PUMP Δ			DIMENSIONS ▲				
	Shipping	Heaviest Section*	Operating	HP	CFM	HP	GPM		Gallons Req'd**	Conn. Size	Operating Weight (lbs)	Height H	Length L	Lower E	Upper U	Coil A
eco-LSWE 4-2F6	2,630	1,500	3,560	3	10,200	3/4	120	33	80	4"	3,140	6' 10"	5' 11-7/8"	3' 7-1/2"	3' 2-1/2"	1'
eco-LSWE 4-2G6	2,640	1,500	3,570	5	12,100	3/4	120	33	80	4"	3,150	6' 10"	5' 11-7/8"	3' 7-1/2"	3' 2-1/2"	1'
eco-LSWE 4-2H6	2,690	1,500	3,620	7.5	13,900	3/4	120	33	80	4"	3,200	6' 10"	5' 11-7/8"	3' 7-1/2"	3' 2-1/2"	1'
eco-LSWE 4-3F6	3,120	1,990	4,170	3	10,000	3/4	120	47	80	4"	3,740	7' 5-1/2"	5' 11-7/8"	3' 7-1/2"	3' 10"	1' 7-1/2"
eco-LSWE 4-3G6	3,130	1,990	4,180	5	11,900	3/4	120	47	80	4"	3,750	7' 5-1/2"	5' 11-7/8"	3' 7-1/2"	3' 10"	1' 7-1/2"
eco-LSWE 4-3H6	3,180	1,990	4,230	7.5	13,600	3/4	120	47	80	4"	3,800	7' 5-1/2"	5' 11-7/8"	3' 7-1/2"	3' 10"	1' 7-1/2"
eco-LSWE 4-3I6	3,200	1,990	4,250	10	15,000	3/4	120	47	80	4"	3,820	7' 5-1/2"	5' 11-7/8"	3' 7-1/2"	3' 10"	1' 7-1/2"
eco-LSWE 4-4F6	3,590	2,460	4,750	3	9,800	3/4	120	60	80	4"	4,320	8' 1"	5' 11-7/8"	3' 7-1/2"	4' 5-1/2"	2' 3"
eco-LSWE 4-4G6	3,600	2,460	4,760	5	11,700	3/4	120	60	80	4"	4,330	8' 1"	5' 11-7/8"	3' 7-1/2"	4' 5-1/2"	2' 3"
eco-LSWE 4-4H6	3,650	2,460	4,810	7.5	13,400	3/4	120	60	80	4"	4,380	8' 1"	5' 11-7/8"	3' 7-1/2"	4' 5-1/2"	2' 3"
eco-LSWE 4-4I6	3,670	2,460	4,830	10	14,700	3/4	120	60	80	4"	4,400	8' 1"	5' 11-7/8"	3' 7-1/2"	4' 5-1/2"	2' 3"
eco-LSWE 4-5G6	4,080	2,940	5,350	5	11,400	3/4	120	74	80	4"	4,930	8' 8-1/2"	5' 11-7/8"	3' 7-1/2"	5' 1"	2' 10-1/2"
eco-LSWE 4-5H6	4,130	2,940	5,400	7.5	13,100	3/4	120	74	80	4"	4,980	8' 8-1/2"	5' 11-7/8"	3' 7-1/2"	5' 1"	2' 10-1/2"
eco-LSWE 4-5I6	4,150	2,940	5,420	10	14,400	3/4	120	74	80	4"	5,000	8' 8-1/2"	5' 11-7/8"	3' 7-1/2"	5' 1"	2' 10-1/2"
eco-LSWE 4-3G9	4,340	2,850	5,920	5	15,600	1	180	68	120	6"	5,370	7' 5-1/2"	8' 11-1/4"	3' 7-1/2"	3' 10"	1' 7-1/2"
eco-LSWE 4-3H9	4,390	2,850	5,970	7.5	17,800	1	180	68	120	6"	5,420	7' 5-1/2"	8' 11-1/4"	3' 7-1/2"	3' 10"	1' 7-1/2"
eco-LSWE 4-3I9	4,410	2,850	5,990	10	19,600	1	180	68	120	6"	5,440	7' 5-1/2"	8' 11-1/4"	3' 7-1/2"	3' 10"	1' 7-1/2"
eco-LSWE 4-3J9	4,530	2,850	6,110	15	22,500	1	180	68	120	6"	5,560	7' 5-1/2"	8' 11-1/4"	3' 7-1/2"	3' 10"	1' 7-1/2"
eco-LSWE 4-4H9	5,080	3,540	6,830	7.5	17,500	1	180	89	120	6"	6,280	8' 1"	8' 11-1/4"	3' 7-1/2"	4' 5-1/2"	2' 3"
eco-LSWE 4-4I9	5,100	3,540	6,850	10	19,200	1	180	89	120	6"	6,300	8' 1"	8' 11-1/4"	3' 7-1/2"	4' 5-1/2"	2' 3"
eco-LSWE 4-4J9	5,220	3,540	6,970	15	22,000	1	180	89	120	6"	6,420	8' 1"	8' 11-1/4"	3' 7-1/2"	4' 5-1/2"	2' 3"
eco-LSWE 4-5H9	5,810	4,270	7,740	7.5	17,100	1	180	109	120	6"	7,180	8' 8-1/2"	8' 11-1/4"	3' 7-1/2"	5' 1"	2' 10-1/2"
eco-LSWE 4-5I9	5,830	4,270	7,760	10	18,800	1	180	109	120	6"	7,200	8' 8-1/2"	8' 11-1/4"	3' 7-1/2"	5' 1"	2' 10-1/2"
eco-LSWE 4-5J9	5,950	4,270	7,880	15	21,600	1	180	109	120	6"	7,320	8' 8-1/2"	8' 11-1/4"	3' 7-1/2"	5' 1"	2' 10-1/2"

Model No. †	WEIGHTS (LBS)			FANS		SPRAY PUMP		Coil Volume (Gallons)	REMOTE PUMP Δ			DIMENSIONS ▲				
	Shipping	Heaviest Section*	Operating	HP	CFM	HP	GPM		Gallons Req'd**	Conn. Size	Operating Weight (lbs)	Height H	Length L	Lower E	Upper U	Coil A
eco-LSWE 4-3H12	5,750	3,780	7,770	7.5	21,600	1.5	245	89	170	6"	7,160	7' 5-1/2"	11' 11-3/4"	3' 7-1/2"	3' 10"	1' 7-1/2"
eco-LSWE 4-3I12	5,770	3,780	7,790	10	23,800	1.5	245	89	170	6"	7,180	7' 5-1/2"	11' 11-3/4"	3' 7-1/2"	3' 10"	1' 7-1/2"
eco-LSWE 4-3J12	5,890	3,780	7,910	15	27,300	1.5	245	89	170	6"	7,300	7' 5-1/2"	11' 11-3/4"	3' 7-1/2"	3' 10"	1' 7-1/2"
eco-LSWE 4-3K12	5,950	3,780	7,970	20	30,000	1.5	245	89	170	6"	7,360	7' 5-1/2"	11' 11-3/4"	3' 7-1/2"	3' 10"	1' 7-1/2"
eco-LSWE 4-4I12	6,710	4,720	8,960	10	23,300	1.5	245	117	170	6"	8,350	8' 1"	11' 11-3/4"	3' 7-1/2"	4' 5-1/2"	2' 3"
eco-LSWE 4-4J12	6,830	4,720	9,080	15	26,700	1.5	245	117	170	6"	8,470	8' 1"	11' 11-3/4"	3' 7-1/2"	4' 5-1/2"	2' 3"
eco-LSWE 4-4K12	6,890	4,720	9,140	20	29,400	1.5	245	117	170	6"	8,530	8' 1"	11' 11-3/4"	3' 7-1/2"	4' 5-1/2"	2' 3"
eco-LSWE 4-5I12	7,610	5,620	10,090	10	22,900	1.5	245	145	170	6"	9,510	8' 8-1/2"	11' 11-3/4"	3' 7-1/2"	5' 1"	2' 10-1/2"
eco-LSWE 4-5J12	7,730	5,620	10,210	15	26,200	1.5	245	145	170	6"	9,630	8' 8-1/2"	11' 11-3/4"	3' 7-1/2"	5' 1"	2' 10-1/2"
eco-LSWE 4-5K12	7,790	5,620	10,270	20	28,800	1.5	245	145	170	6"	9,690	8' 8-1/2"	11' 11-3/4"	3' 7-1/2"	5' 1"	2' 10-1/2"
eco-LSWE 4-3I18	8,330	5,570	11,230	10	31,300	2	365	132	250	8"	10,040	7' 5-1/2"	18'	3' 7-1/2"	3' 10"	1' 7-1/2"
eco-LSWE 4-3J18	8,450	5,570	11,350	15	35,800	2	365	132	250	8"	10,160	7' 5-1/2"	18'	3' 7-1/2"	3' 10"	1' 7-1/2"
eco-LSWE 4-3K18	8,510	5,570	11,410	20	39,400	2	365	132	250	8"	10,220	7' 5-1/2"	18'	3' 7-1/2"	3' 10"	1' 7-1/2"
eco-LSWE 4-3L18	8,540	5,570	11,440	25	42,400	2	365	132	250	8"	10,250	7' 5-1/2"	18'	3' 7-1/2"	3' 10"	1' 7-1/2"
eco-LSWE 4-4J18	9,830	6,950	13,080	15	35,100	2	365	174	250	8"	11,900	8' 1"	18'	3' 7-1/2"	4' 5-1/2"	2' 3"
eco-LSWE 4-4K18	9,890	6,950	13,140	20	38,600	2	365	174	250	8"	11,960	8' 1"	18'	3' 7-1/2"	4' 5-1/2"	2' 3"
eco-LSWE 4-4L18	9,920	6,950	13,170	25	41,600	2	365	174	250	8"	11,990	8' 1"	18'	3' 7-1/2"	4' 5-1/2"	2' 3"
eco-LSWE 4-5J18	11,190	8,310	14,790	15	34,400	2	365	215	250	8"	13,610	8' 8-1/2"	18'	3' 7-1/2"	5' 1"	2' 10-1/2"
eco-LSWE 4-5K18	11,250	8,310	14,850	20	37,800	2	365	215	250	8"	13,670	8' 8-1/2"	18'	3' 7-1/2"	5' 1"	2' 10-1/2"
eco-LSWE 4-5L18	11,280	8,310	14,880	25	40,800	2	365	215	250	8"	13,700	8' 8-1/2"	18'	3' 7-1/2"	5' 1"	2' 10-1/2"
eco-LSWE 4-5M18	11,330	8,310	14,930	30	43,300	2	365	215	250	8"	13,750	8' 8-1/2"	18'	3' 7-1/2"	5' 1"	2' 10-1/2"

† Model Number will end in "-Z" for units with Series Flow piping configuration. Series Flow units may require additional coil connections and will require crossover piping. Model numbers will include "I" for units with Intake Attenuation, "D" for units with Discharge Attenuation, "F" for units with Full Sound Attenuation, "T" for units with a Tapered Discharge Hood, and "S" for units with an option that negates CTI Certification.

\* Heaviest section is the coil section.

\*\* Gallons shown is water in suspension in unit and piping. Allow for additional water in bottom of remote sump to cover pump suction and strainer during operation (12" would normally be sufficient).

Δ When a remote sump arrangement is selected, the spray pump, suction strainer and associated piping are omitted; the unit is provided with an oversized outlet to facilitate drainage to the remote sump.

▲ Unit dimensions and coil connections may vary slightly from catalog. See factory certified prints for dimensions, quantity of coil connections, and piping configuration. Coil connections are 4" bevel for weld (BFW), also available as options. Other connection types such as grooved for mechanical coupling or flanged are also available as options.

† Model Number will end in "-Z" for units with Series Flow piping configuration. Series Flow units may require additional coil connections and will require crossover piping. Model numbers will include "I" for units with Intake Attenuation, "D" for units with Discharge Attenuation, "F" for units with Full Sound Attenuation, "T" for units with a Tapered Discharge Hood, and "S" for units with an option that negates CTI Certification.

\* Heaviest section is the coil section.

\*\* Gallons shown is water in suspension in unit and piping. Allow for additional water in bottom of remote sump to cover pump suction and strainer during operation (12" would normally be sufficient).

Δ When a remote sump arrangement is selected, the spray pump, suction strainer and associated piping are omitted; the unit is provided with an oversized outlet to facilitate drainage to the remote sump.

▲ Unit dimensions and coil connections may vary slightly from catalog. See factory certified prints for dimensions, quantity of coil connections, and piping configuration. Coil connections are 4" bevel for weld (BFW), also available as options. Other connection types such as grooved for mechanical coupling or flanged are also available as options.



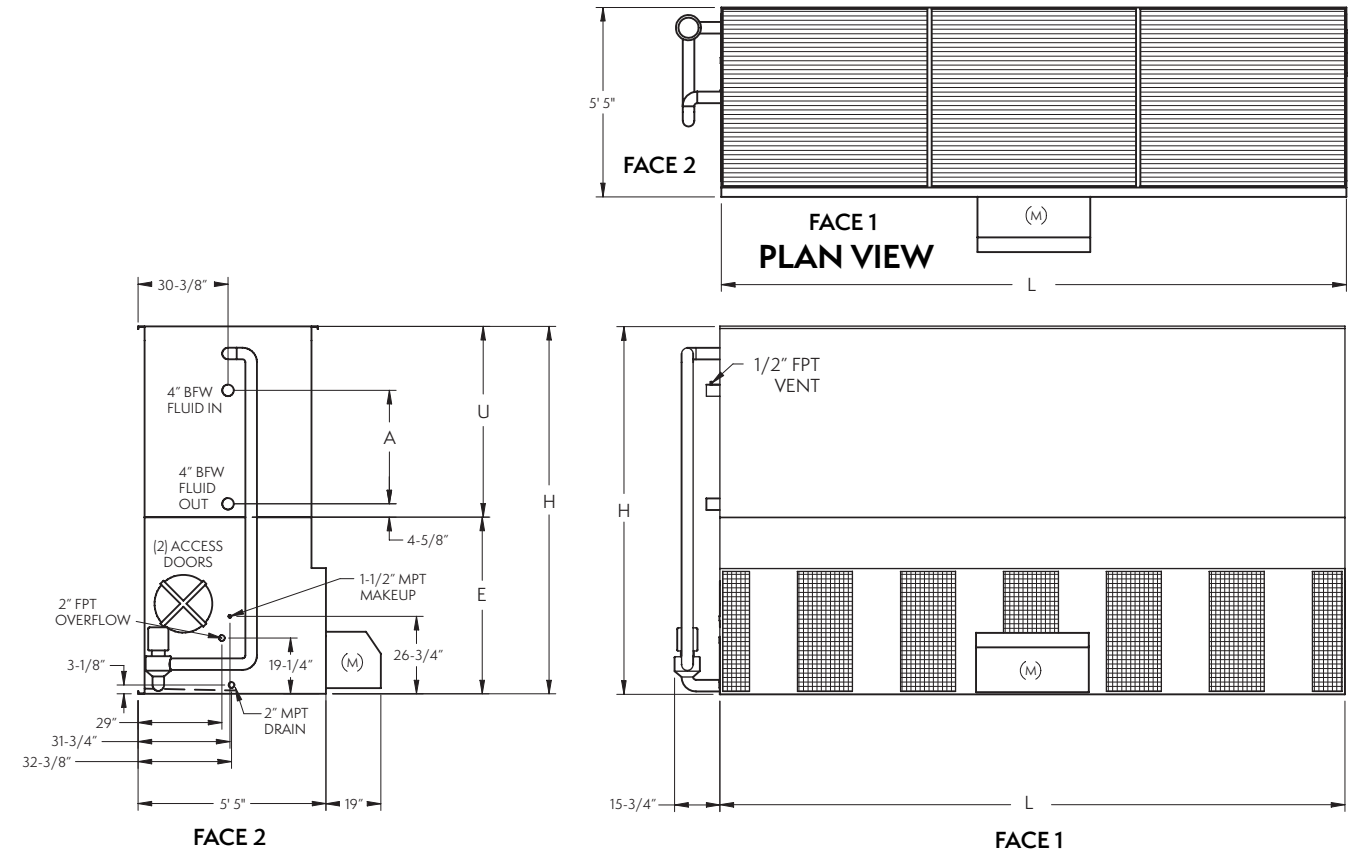
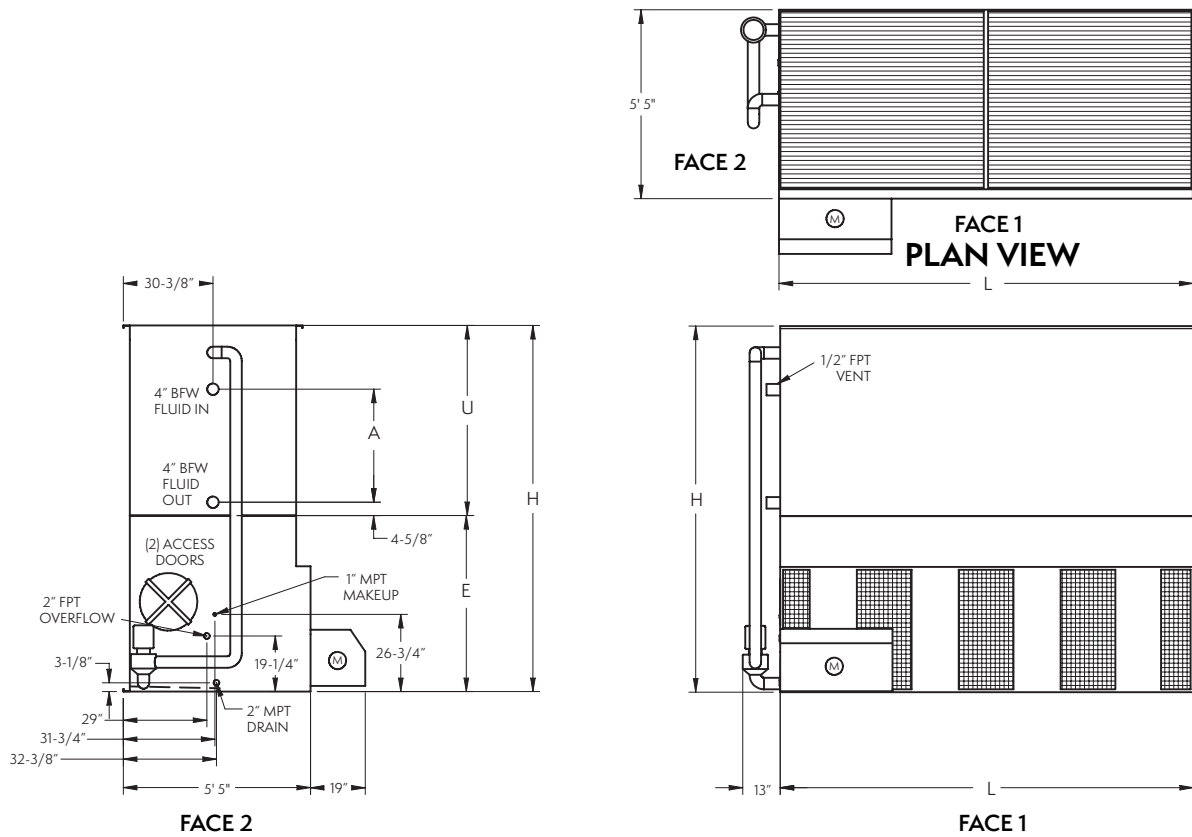

NOTE: The number of coil connections may increase based on design flow rate.

Model No. †	WEIGHTS (LBS)			FANS		SPRAY PUMP		Coil Volume (Gallons)	REMOTE PUMP Δ			DIMENSIONS ▲				
	Shipping	Heaviest Section*	Operating	HP	CFM	HP	GPM		Gallons Req'd**	Conn. Size	Operating Weight (lbs)	Height H	Length L	Lower E	Upper U	Coil A
eco-LSWE 5-3I12	7,640	5,070	11,120	10	29,900	2	345	127	230	6"	9,400	9' 2-1/8"	11' 11-1/2"	5' 1-1/8"	4' 1"	1' 10-1/4"
eco-LSWE 5-3J12	7,760	5,070	11,240	15	34,200	2	345	127	230	6"	9,520	9' 2-1/8"	11' 11-1/2"	5' 1-1/8"	4' 1"	1' 10-1/4"
eco-LSWE 5-3K12	7,820	5,070	11,300	20	37,700	2	345	127	230	6"	9,580	9' 2-1/8"	11' 11-1/2"	5' 1-1/8"	4' 1"	1' 10-1/4"
eco-LSWE 5-3L12	7,850	5,070	11,330	25	40,600	2	345	127	230	6"	9,610	9' 2-1/8"	11' 11-1/2"	5' 1-1/8"	4' 1"	1' 10-1/4"
eco-LSWE 5-4I12	8,960	6,390	12,770	10	29,300	2	345	166	230	6"	11,080	9' 10-5/8"	11' 11-1/2"	5' 1-1/8"	4' 9-1/2"	2' 6-3/4"
eco-LSWE 5-4J12	9,080	6,390	12,890	15	33,600	2	345	166	230	6"	11,200	9' 10-5/8"	11' 11-1/2"	5' 1-1/8"	4' 9-1/2"	2' 6-3/4"
eco-LSWE 5-4K12	9,140	6,390	12,950	20	36,900	2	345	166	230	6"	11,260	9' 10-5/8"	11' 11-1/2"	5' 1-1/8"	4' 9-1/2"	2' 6-3/4"
eco-LSWE 5-4L12	9,170	6,390	12,980	25	39,800	2	345	166	230	6"	11,290	9' 10-5/8"	11' 11-1/2"	5' 1-1/8"	4' 9-1/2"	2' 6-3/4"
eco-LSWE 5-5J12	10,430	7,740	14,570	15	32,900	2	345	206	230	6"	12,890	10' 7-1/8"	11' 11-1/2"	5' 1-1/8"	5' 6"	3' 3-1/4"
eco-LSWE 5-5K12	10,490	7,740	14,630	20	36,200	2	345	206	230	6"	12,950	10' 7-1/8"	11' 11-1/2"	5' 1-1/8"	5' 6"	3' 3-1/4"
eco-LSWE 5-5L12	10,520	7,740	14,660	25	39,000	2	345	206	230	6"	12,980	10' 7-1/8"	11' 11-1/2"	5' 1-1/8"	5' 6"	3' 3-1/4"
eco-LSWE 5-6J12	11,760	9,070	16,230	15	32,200	2	345	245	230	6"	14,560	11' 3-5/8"	11' 11-1/2"	5' 1-1/8"	6' 2-1/2"	3' 11-3/4"
eco-LSWE 5-6K12	11,820	9,070	16,290	20	35,500	2	345	245	230	6"	14,620	11' 3-5/8"	11' 11-1/2"	5' 1-1/8"	6' 2-1/2"	3' 11-3/4"
eco-LSWE 5-6L12	11,850	9,070	16,320	25	38,200	2	345	245	230	6"	14,650	11' 3-5/8"	11' 11-1/2"	5' 1-1/8"	6' 2-1/2"	3' 11-3/4"
eco-LSWE 5-6M12	11,900	9,070	16,370	30	40,600	2	345	245	230	6"	14,700	11' 3-5/8"	11' 11-1/2"	5' 1-1/8"	6' 2-1/2"	3' 11-3/4"

† Model Number will end in "-Z" for units with Series Flow piping configuration. Series Flow units may require additional coil connections and will require crossover piping. Model numbers will include "I" for units with Intake Attenuation, "D" for units with Discharge Attenuation, "F" for units with Full Sound Attenuation, "T" for units with a Tapered Discharge Hood, and "S" for units with an option that negates CTI Certification.

\* Heaviest section is the coil section.

\*\* Gallons shown is water in suspension in unit and piping. Allow for additional water in bottom of remote sump to cover pump suction and strainer during operation (12" would normally be sufficient).

Δ When a remote sump arrangement is selected, the spray pump, suction strainer and associated piping are omitted; the unit is provided with an oversized outlet to facilitate drainage to the remote sump.

▲ Unit dimensions and coil connections may vary slightly from catalog. See factory certified prints for dimensions, quantity of coil connections, and piping configuration. Coil connections are 4" bevel for weld (BFW), also available as options. Other connection types such as grooved for mechanical coupling or flanged are also available as options.

Model No. †	WEIGHTS (LBS)			FANS		SPRAY PUMP		Coil Volume (Gallons)	REMOTE PUMP Δ			DIMENSIONS ▲				
	Shipping	Heaviest Section*	Operating	HP	CFM	HP	GPM		Gallons Req'd**	Conn. Size	Operating Weight (lbs)	Height H	Length L	Lower E	Upper U	Coil A
eco-LSWE 5-3J18	11,470	7,590	16,460	15	45,000	3	515	187	340	8"	13,480	9' 2-1/8"	17' 11-7/8"	5' 1-1/8"	4' 1"	1' 10-1/4"
eco-LSWE 5-3K18	11,530	7,590	16,520	20	49,500	3	515	187	340	8"	13,540	9' 2-1/8"	17' 11-7/8"	5' 1-1/8"	4' 1"	1' 10-1/4"
eco-LSWE 5-3L18	11,560	7,590	16,550	25	53,300	3	515	187	340	8"	13,570	9' 2-1/8"	17' 11-7/8"	5' 1-1/8"	4' 1"	1' 10-1/4"
eco-LSWE 5-3M18	11,610	7,590	16,600	30	56,600	3	515	187	340	8"	13,620	9' 2-1/8"	17' 11-7/8"	5' 1-1/8"	4' 1"	1' 10-1/4"
eco-LSWE 5-4K18	13,510	9,570	18,990	20	48,500	3	515	247	340	8"	16,010	9' 10-5/8"	17' 11-7/8"	5' 1-1/8"	4' 9-1/2"	2' 6-3/4"
eco-LSWE 5-4L18	13,540	9,570	19,020	25	52,300	3	515	247	340	8"	16,040	9' 10-5/8"	17' 11-7/8"	5' 1-1/8"	4' 9-1/2"	2' 6-3/4"
eco-LSWE 5-4M18	13,590	9,570	19,070	30	55,500	3	515	247	340	8"	16,090	9' 10-5/8"	17' 11-7/8"	5' 1-1/8"	4' 9-1/2"	2' 6-3/4"
eco-LSWE 5-4N18	13,750	9,570	19,230	40	61,100	3	515	247	340	8"	16,250	9' 10-5/8"	17' 11-7/8"	5' 1-1/8"	4' 9-1/2"	2' 6-3/4"
eco-LSWE 5-5K18	15,560	11,620	21,540	20	47,500	3	515	306	340	8"	18,580	10' 7-1/8"	17' 11-7/8"	5' 1-1/8"	5' 6"	3' 3-1/4"
eco-LSWE 5-5L18	15,590	11,620	21,570	25	51,200	3	515	306	340	8"	18,610	10' 7-1/8"	17' 11-7/8"	5' 1-1/8"	5' 6"	3' 3-1/4"
eco-LSWE 5-5M18	15,640	11,620	21,620	30	54,400	3	515	306	340	8"	18,660	10' 7-1/8"	17' 11-7/8"	5' 1-1/8"	5' 6"	3' 3-1/4"
eco-LSWE 5-5N18	15,800	11,620	21,780	40	59,900	3	515	306	340	8"	18,820	10' 7-1/8"	17' 11-7/8"	5' 1-1/8"	5' 6"	3' 3-1/4"
eco-LSWE 5-6L18	17,590	13,620	24,070	25	50,200	3	515	366	340	8"	21,140	11' 3-5/8"	17' 11-7/8"	5' 1-1/8"	6' 2-1/2"	3' 11-3/4"
eco-LSWE 5-6M18	17,640	13,620	24,120	30	53,300	3	515	366	340	8"	21,190	11' 3-5/8"	17' 11-7/8"	5' 1-1/8"	6' 2-1/2"	3' 11-3/4"
eco-LSWE 5-6N18	17,800	13,620	24,280	40	58,700	3	515	366	340	8"	21,350	11' 3-5/8"	17' 11-7/8"	5' 1-1/8"	6' 2-1/2"	3' 11-3/4"

† Model Number will end in "-Z" for units with Series Flow piping configuration. Series Flow units may require additional coil connections and will require crossover piping. Model numbers will include "I" for units with Intake Attenuation, "D" for units with Discharge Attenuation, "F" for units with Full Sound Attenuation, "T" for units with a Tapered Discharge Hood, and "S" for units with an option that negates CTI Certification.

\* Heaviest section is the coil section.

\*\* Gallons shown is water in suspension in unit and piping. Allow for additional water in bottom of remote sump to cover pump suction and strainer during operation (12" would normally be sufficient).

Δ When a remote sump arrangement is selected, the spray pump, suction strainer and associated piping are omitted; the unit is provided with an oversized outlet to facilitate drainage to the remote sump.

▲ Unit dimensions and coil connections may vary slightly from catalog. See factory certified prints for dimensions, quantity of coil connections, and piping configuration. Coil connections are 4" bevel for weld (BFW), also available as options. Other connection types such as grooved for mechanical coupling or flanged are also available as options.



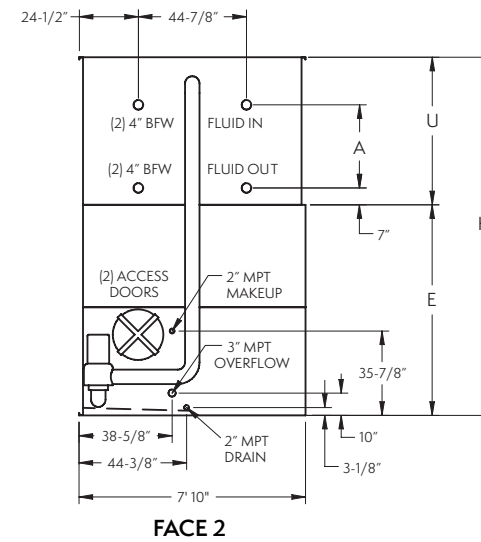
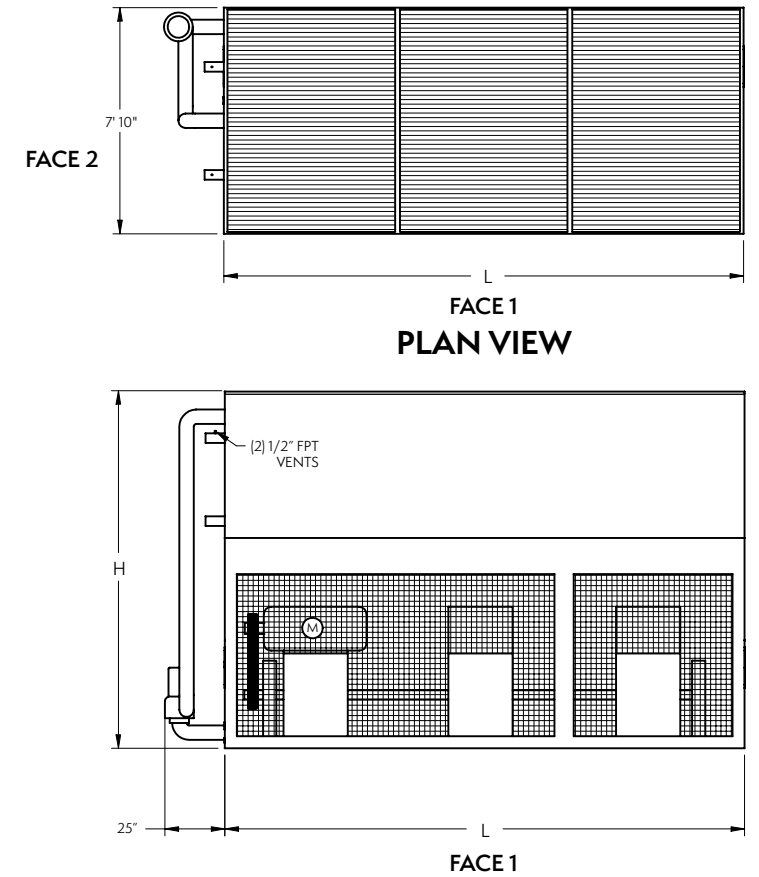
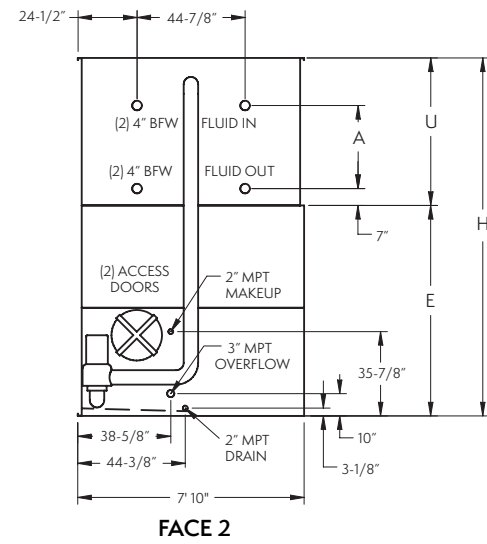
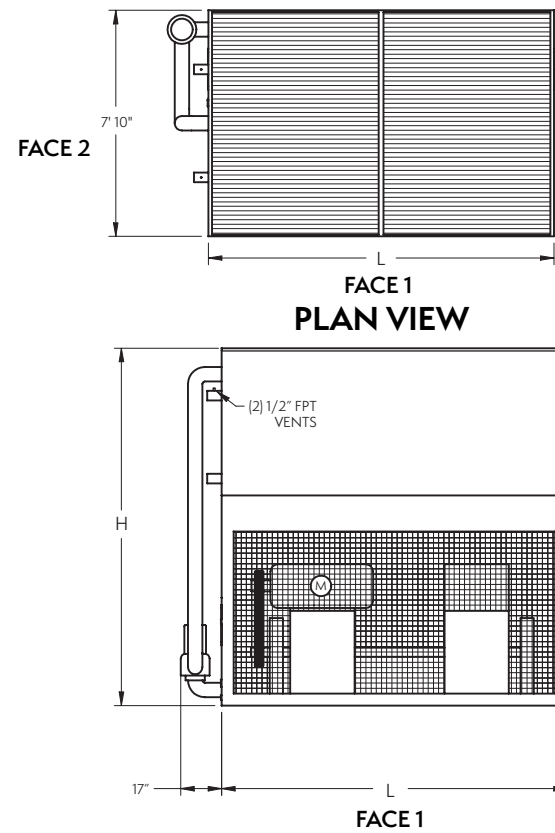

Model No. †	WEIGHTS (LBS)			FANS		SPRAY PUMP		Coil Volume (Gallons)	REMOTE PUMP Δ			DIMENSIONS ▲				
	Shipping	Heaviest Section*	Operating	HP	CFM	HP	GPM		Gallons Req'd**	Conn. Size	Operating Weight (lbs)	Height H	Length L	Lower E	Upper U	Coil A
eco-LSWE 8P-3K12	11,400	7,610	16,440	20	48,600	5	570	200	360	10"	14,470	11'1-5/8"	11'11-3/4"	7'3-3/8"	3'10-1/4"	1'7-1/2"
eco-LSWE 8P-3L12	11,430	7,610	16,470	25	52,400	5	570	200	360	10"	14,500	11'1-5/8"	11'11-3/4"	7'3-3/8"	3'10-1/4"	1'7-1/2"
eco-LSWE 8P-3M12	11,480	7,610	16,520	30	55,700	5	570	200	360	10"	14,550	11'1-5/8"	11'11-3/4"	7'3-3/8"	3'10-1/4"	1'7-1/2"
eco-LSWE 8P-3N12	11,640	7,610	16,680	40	61,300	5	570	200	360	10"	14,710	11'1-5/8"	11'11-3/4"	7'3-3/8"	3'10-1/4"	1'7-1/2"
eco-LSWE 8P-4L12	13,450	9,630	19,010	25	51,300	5	570	262	360	10"	17,150	11'9-1/8"	11'11-3/4"	7'3-3/8"	4'5-3/4"	2'3"
eco-LSWE 8P-4M12	13,500	9,630	19,060	30	54,600	5	570	262	360	10"	17,200	11'9-1/8"	11'11-3/4"	7'3-3/8"	4'5-3/4"	2'3"
eco-LSWE 8P-4N12	13,660	9,630	19,220	40	60,100	5	570	262	360	10"	17,360	11'9-1/8"	11'11-3/4"	7'3-3/8"	4'5-3/4"	2'3"
eco-LSWE 8P-4O12	13,670	9,630	19,230	50	64,700	5	570	262	360	10"	17,370	11'9-1/8"	11'11-3/4"	7'3-3/8"	4'5-3/4"	2'3"
eco-LSWE 8P-5M12	15,460	11,590	21,540	30	53,500	5	570	324	360	10"	19,790	12'4-5/8"	11'11-3/4"	7'3-3/8"	5'1-1/4"	2'10-1/2"
eco-LSWE 8P-5N12	15,620	11,590	21,700	40	58,900	5	570	324	360	10"	19,950	12'4-5/8"	11'11-3/4"	7'3-3/8"	5'1-1/4"	2'10-1/2"
eco-LSWE 8P-5O12	15,630	11,590	21,710	50	63,400	5	570	324	360	10"	19,960	12'4-5/8"	11'11-3/4"	7'3-3/8"	5'1-1/4"	2'10-1/2"
eco-LSWE 8P-6M12	17,470	13,600	24,070	30	52,400	5	570	386	360	10"	22,440	13'1/8"	11'11-3/4"	7'3-3/8"	5'8-3/4"	3'6"
eco-LSWE 8P-6N12	17,630	13,600	24,230	40	57,700	5	570	386	360	10"	22,600	13'1/8"	11'11-3/4"	7'3-3/8"	5'8-3/4"	3'6"
eco-LSWE 8P-6O12	17,640	13,600	24,240	50	62,100	5	570	386	360	10"	22,610	13'1/8"	11'11-3/4"	7'3-3/8"	5'8-3/4"	3'6"

† Model Number will end in "-Z" for units with Series Flow piping configuration. Series Flow units may require additional coil connections and will require crossover piping. Model numbers will include "I" for units with Intake Attenuation, "D" for units with Discharge Attenuation, "F" for units with Full Sound Attenuation, "T" for units with a Tapered Discharge Hood, and "S" for units with an option that negates CTI Certification.  
 \* Heaviest section is the coil section.  
 \*\* Gallons shown is water in suspension in unit and piping. Allow for additional water in bottom of remote sump to cover pump suction and strainer during operation (12" would normally be sufficient).  
 Δ When a remote sump arrangement is selected, the spray pump, suction strainer and associated piping are omitted; the unit is provided with an oversized outlet to facilitate drainage to the remote sump.  
 ▲ Unit dimensions and coil connections may vary slightly from catalog. See factory certified prints for dimensions, quantity of coil connections, and piping configuration. Coil connections are 4" bevel for weld (BFW), also available as options. Other connection types such as grooved for mechanical coupling or flanged are also available as options.

NOTE: The number of coil connections may increase based on design flow rate.

Model No. †	WEIGHTS (LBS)			FANS		SPRAY PUMP		Coil Volume (Gallons)	REMOTE PUMP Δ			DIMENSIONS ▲				
	Shipping	Heaviest Section*	Operating	HP	CFM	HP	GPM		Gallons Req'd**	Conn. Size	Operating Weight (lbs)	Height H	Length L	Lower E	Upper U	Coil A
eco-LSWE 8P-3M18	16,520	11,280	24,120	30	72,800	7.5	840	295	530	12"	21,220	11'1-5/8"	18'	7'3-3/8"	3'10-1/4"	1'7-1/2"
eco-LSWE 8P-3N18	16,680	11,280	24,280	40	80,100	7.5	840	295	530	12"	21,380	11'1-5/8"	18'	7'3-3/8"	3'10-1/4"	1'7-1/2"
eco-LSWE 8P-3O18	16,690	11,280	24,290	50	86,300	7.5	840	295	530	12"	21,390	11'1-5/8"	18'	7'3-3/8"	3'10-1/4"	1'7-1/2"
eco-LSWE 8P-3P18	16,890	11,280	24,490	60	91,700	7.5	840	295	530	12"	21,590	11'1-5/8"	18'	7'3-3/8"	3'10-1/4"	1'7-1/2"
eco-LSWE 8P-4M18	19,550	14,310	27,930	30	71,300	7.5	840	389	530	12"	25,210	11'9-1/8"	18'	7'3-3/8"	4'5-3/4"	2'3"
eco-LSWE 8P-4N18	19,710	14,310	28,090	40	78,500	7.5	840	389	530	12"	25,370	11'9-1/8"	18'	7'3-3/8"	4'5-3/4"	2'3"
eco-LSWE 8P-4O18	19,720	14,310	28,100	50	84,600	7.5	840	389	530	12"	25,380	11'9-1/8"	18'	7'3-3/8"	4'5-3/4"	2'3"
eco-LSWE 8P-4P18	19,920	14,310	28,300	60	89,900	7.5	840	389	530	12"	25,580	11'9-1/8"	18'	7'3-3/8"	4'5-3/4"	2'3"
eco-LSWE 8P-5N18	22,630	17,230	31,790	40	77,000	7.5	840	483	530	12"	29,240	12'4-5/8"	18'	7'3-3/8"	5'1-1/4"	2'10-1/2"
eco-LSWE 8P-5O18	22,640	17,230	31,800	50	82,900	7.5	840	483	530	12"	29,250	12'4-5/8"	18'	7'3-3/8"	5'1-1/4"	2'10-1/2"
eco-LSWE 8P-5P18	22,840	17,230	32,000	60	88,100	7.5	840	483	530	12"	29,450	12'4-5/8"	18'	7'3-3/8"	5'1-1/4"	2'10-1/2"
eco-LSWE 8P-6N18	25,700	20,300	35,650	40	75,400	7.5	840	577	530	12"	33,260	13'1/8"	18'	7'3-3/8"	5'8-3/4"	3'6"
eco-LSWE 8P-6O18	25,710	20,300	35,660	50	81,200	7.5	840	577	530	12"	33,270	13'1/8"	18'	7'3-3/8"	5'8-3/4"	3'6"
eco-LSWE 8P-6P18	25,910	20,300	35,860	60	86,300	7.5	840	577	530	12"	33,470	13'1/8"	18'	7'3-3/8"	5'8-3/4"	3'6"

† Model Number will end in "-Z" for units with Series Flow piping configuration. Series Flow units may require additional coil connections and will require crossover piping. Model numbers will include "I" for units with Intake Attenuation, "D" for units with Discharge Attenuation, "F" for units with Full Sound Attenuation, "T" for units with a Tapered Discharge Hood, and "S" for units with an option that negates CTI Certification.  
 \* Heaviest section is the coil section.  
 \*\* Gallons shown is water in suspension in unit and piping. Allow for additional water in bottom of remote sump to cover pump suction and strainer during operation (12" would normally be sufficient).  
 Δ When a remote sump arrangement is selected, the spray pump, suction strainer and associated piping are omitted; the unit is provided with an oversized outlet to facilitate drainage to the remote sump.  
 ▲ Unit dimensions and coil connections may vary slightly from catalog. See factory certified prints for dimensions, quantity of coil connections, and piping configuration. Coil connections are 4" bevel for weld (BFW), also available as options. Other connection types such as grooved for mechanical coupling or flanged are also available as options.

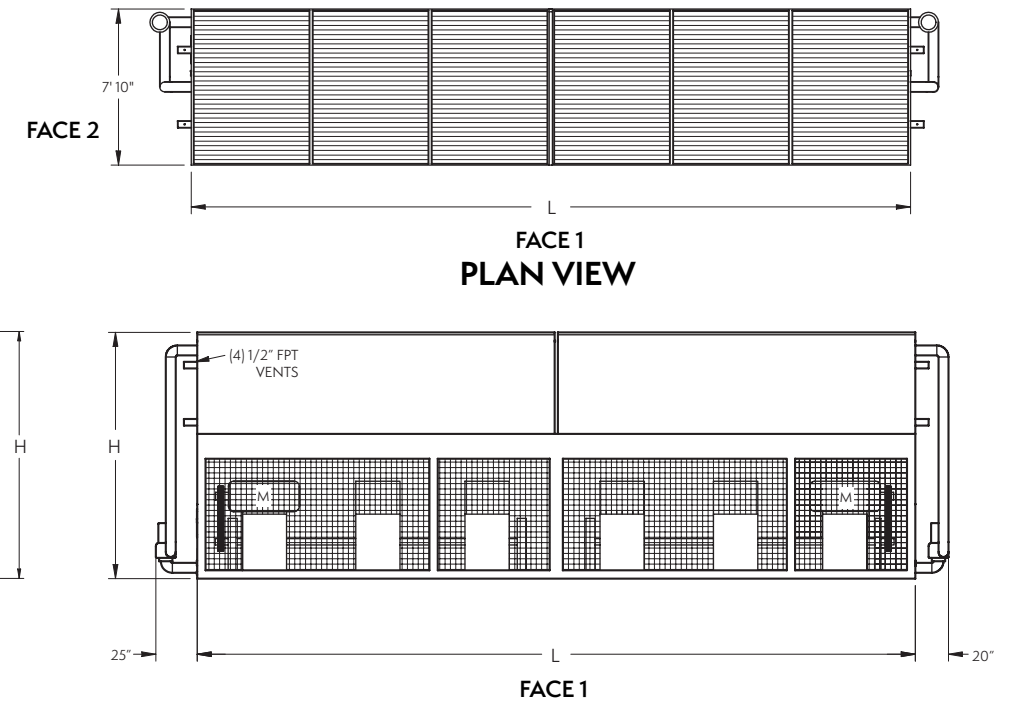
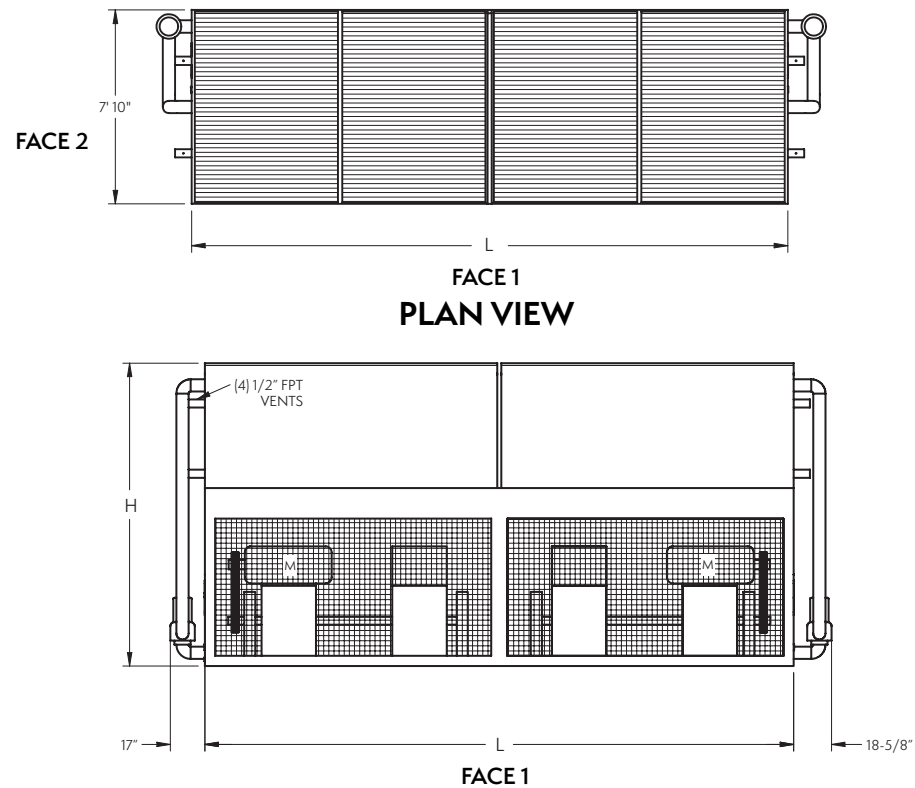

NOTE: The number of coil connections may increase based on design flow rate.

Model No. †	WEIGHTS (LBS)			FANS		SPRAY PUMP		Coil Volume (Gallons)	REMOTE PUMP Δ			DIMENSIONS ▲				
	Shipping	Heaviest Section	Operating	HP	CFM	HP	GPM		Gallons Req'd**	Conn. Size	Operating Weight (lbs)	Height H	Length L	Lower E	Upper U	Coil A
eco-LSWE 8P-3K24	22,120	7,610	32,270	(2) 20	97,200	(2) 5	1140	400	720	(2) 10"	29,130	11' 1-5/8"	24' 1"	7' 3-3/8"	3' 10-1/4"	1' 7-1/2"
eco-LSWE 8P-3L24	22,180	7,610	32,330	(2) 25	104,700	(2) 5	1140	400	720	(2) 10"	29,250	11' 1-5/8"	24' 1"	7' 3-3/8"	3' 10-1/4"	1' 7-1/2"
eco-LSWE 8P-3M24	22,280	7,610	32,430	(2) 30	111,300	(2) 5	1140	400	720	(2) 10"	29,450	11' 1-5/8"	24' 1"	7' 3-3/8"	3' 10-1/4"	1' 7-1/2"
eco-LSWE 8P-3N24	22,600	7,610	32,750	(2) 40	122,500	(2) 5	1140	400	720	(2) 10"	30,090	11' 1-5/8"	24' 1"	7' 3-3/8"	3' 10-1/4"	1' 7-1/2"
eco-LSWE 8P-4L24	26,200	9,620	37,390	(2) 25	102,700	(2) 5	1140	524	720	(2) 10"	34,570	11' 9-1/8"	24' 1"	7' 3-3/8"	4' 5-3/4"	2' 3"
eco-LSWE 8P-4M24	26,300	9,620	37,490	(2) 30	109,100	(2) 5	1140	524	720	(2) 10"	34,770	11' 9-1/8"	24' 1"	7' 3-3/8"	4' 5-3/4"	2' 3"
eco-LSWE 8P-4N24	26,620	9,620	37,810	(2) 40	120,100	(2) 5	1140	524	720	(2) 10"	35,410	11' 9-1/8"	24' 1"	7' 3-3/8"	4' 5-3/4"	2' 3"
eco-LSWE 8P-4O24	26,640	9,620	37,830	(2) 50	129,400	(2) 5	1140	524	720	(2) 10"	35,450	11' 9-1/8"	24' 1"	7' 3-3/8"	4' 5-3/4"	2' 3"
eco-LSWE 8P-5M24	30,240	11,590	42,470	(2) 30	106,900	(2) 5	1140	648	720	(2) 10"	39,960	12' 4-5/8"	24' 1"	7' 3-3/8"	5' 1-1/4"	2' 10-1/2"
eco-LSWE 8P-5N24	30,560	11,590	42,790	(2) 40	117,700	(2) 5	1140	648	720	(2) 10"	40,600	12' 4-5/8"	24' 1"	7' 3-3/8"	5' 1-1/4"	2' 10-1/2"
eco-LSWE 8P-5O24	30,580	11,590	42,810	(2) 50	126,800	(2) 5	1140	648	720	(2) 10"	40,640	12' 4-5/8"	24' 1"	7' 3-3/8"	5' 1-1/4"	2' 10-1/2"
eco-LSWE 8P-6M24	34,260	13,600	47,530	(2) 30	104,800	(2) 5	1140	772	720	(2) 10"	45,270	13' 1/8"	24' 1"	7' 3-3/8"	5' 8-3/4"	3' 6"
eco-LSWE 8P-6N24	34,580	13,600	47,850	(2) 40	115,300	(2) 5	1140	772	720	(2) 10"	45,910	13' 1/8"	24' 1"	7' 3-3/8"	5' 8-3/4"	3' 6"
eco-LSWE 8P-6O24	34,600	13,600	47,870	(2) 50	124,200	(2) 5	1140	772	720	(2) 10"	45,950	13' 1/8"	24' 1"	7' 3-3/8"	5' 8-3/4"	3' 6"

† Model Number will end in "-Z" for units with Series Flow piping configuration. Series Flow units may require additional coil connections and will require crossover piping. Model numbers will include "I" for units with Intake Attenuation, "D" for units with Discharge Attenuation, "F" for units with Full Sound Attenuation, "T" for units with a Tapered Discharge Hood, and "S" for units with an option that negates CTI Certification.

\* Heaviest section is the coil section.

\*\* Gallons shown is water in suspension in unit and piping. Allow for additional water in bottom of remote sump to cover pump suction and strainer during operation (12" would normally be sufficient).

Δ When a remote sump arrangement is selected, the spray pump, suction strainer and associated piping are omitted; the unit is provided with an oversized outlet to facilitate drainage to the remote sump.

▲ Unit dimensions and coil connections may vary slightly from catalog. See factory certified prints for dimensions, quantity of coil connections, and piping configuration. Coil connections are 4" bevel for weld (BFW), also available as options. Other connection types such as grooved for mechanical coupling or flanged are also available as options.

Model No. †	WEIGHTS (LBS)			FANS		SPRAY PUMP		Coil Volume (Gallons)	REMOTE PUMP Δ			DIMENSIONS ▲				
	Shipping	Heaviest Section	Operating	HP	CFM	HP	GPM		Gallons Req'd**	Conn. Size	Operating Weight (lbs)	Height H	Length L	Lower E	Upper U	Coil A
eco-LSWE 8P-3M36	32,290	11,280	47,590	(2) 30	145,600	(2) 7.5	1,680	590	1,060	(2) 12"	42,800	11' 1-5/8"	36' 2"	7' 3-3/8"	3' 10-1/4"	1' 7-1/2"
eco-LSWE 8P-3N36	32,610	11,280	47,910	(2) 40	160,200	(2) 7.5	1,680	590	1,060	(2) 12"	43,440	11' 1-5/8"	36' 2"	7' 3-3/8"	3' 10-1/4"	1' 7-1/2"
eco-LSWE 8P-3O36	32,630	11,280	47,930	(2) 50	172,600	(2) 7.5	1,680	590	1,060	(2) 12"	43,480	11' 1-5/8"	36' 2"	7' 3-3/8"	3' 10-1/4"	1' 7-1/2"
eco-LSWE 8P-3P36	33,030	11,280	48,330	(2) 60	183,400	(2) 7.5	1,680	590	1,060	(2) 12"	44,280	11' 1-5/8"	36' 2"	7' 3-3/8"	3' 10-1/4"	1' 7-1/2"
eco-LSWE 8P-4M36	38,370	14,320	55,230	(2) 30	142,700	(2) 7.5	1,680	778	1,060	(2) 12"	50,780	11' 9-1/8"	36' 2"	7' 3-3/8"	4' 5-3/4"	2' 3"
eco-LSWE 8P-4N36	38,690	14,320	55,550	(2) 40	157,100	(2) 7.5	1,680	778	1,060	(2) 12"	51,420	11' 9-1/8"	36' 2"	7' 3-3/8"	4' 5-3/4"	2' 3"
eco-LSWE 8P-4O36	38,710	14,320	55,570	(2) 50	169,200	(2) 7.5	1,680	778	1,060	(2) 12"	51,460	11' 9-1/8"	36' 2"	7' 3-3/8"	4' 5-3/4"	2' 3"
eco-LSWE 8P-4P36	39,110	14,320	55,970	(2) 60	179,800	(2) 7.5	1,680	778	1,060	(2) 12"	52,260	11' 9-1/8"	36' 2"	7' 3-3/8"	4' 5-3/4"	2' 3"
eco-LSWE 8P-5N36	44,550	17,250	62,970	(2) 40	153,900	(2) 7.5	1,680	966	1,060	(2) 12"	59,210	12' 4-5/8"	36' 2"	7' 3-3/8"	5' 1-1/4"	2' 10-1/2"
eco-LSWE 8P-5O36	44,570	17,250	62,990	(2) 50	165,800	(2) 7.5	1,680	966	1,060	(2) 12"	59,250	12' 4-5/8"	36' 2"	7' 3-3/8"	5' 1-1/4"	2' 10-1/2"
eco-LSWE 8P-5P36	44,970	17,250	63,390	(2) 60	176,200	(2) 7.5	1,680	966	1,060	(2) 12"	60,050	12' 4-5/8"	36' 2"	7' 3-3/8"	5' 1-1/4"	2' 10-1/2"
eco-LSWE 8P-6N36	50,650	20,300	70,650	(2) 40	150,800	(2) 7.5	1,680	1,153	1,060	(2) 12"	67,210	13' 1/8"	36' 2"	7' 3-3/8"	5' 8-3/4"	3' 6"
eco-LSWE 8P-6O36	50,670	20,300	70,670	(2) 50	162,400	(2) 7.5	1,680	1,153	1,060	(2) 12"	67,250	13' 1/8"	36' 2"	7' 3-3/8"	5' 8-3/4"	3' 6"
eco-LSWE 8P-6P36	51,070	20,300	71,070	(2) 60	172,600	(2) 7.5	1,680	1,153	1,060	(2) 12"	68,050	13' 1/8"	36' 2"	7' 3-3/8"	5' 8-3/4"	3' 6"

† Model Number will end in "-Z" for units with Series Flow piping configuration. Series Flow units may require additional coil connections and will require crossover piping. Model numbers will include "I" for units with Intake Attenuation, "D" for units with Discharge Attenuation, "F" for units with Full Sound Attenuation, "T" for units with a Tapered Discharge Hood, and "S" for units with an option that negates CTI Certification.

\* Heaviest section is the coil section.

\*\* Gallons shown is water in suspension in unit and piping. Allow for additional water in bottom of remote sump to cover pump suction and strainer during operation (12" would normally be sufficient).

Δ When a remote sump arrangement is selected, the spray pump, suction strainer and associated piping are omitted; the unit is provided with an oversized outlet to facilitate drainage to the remote sump.

▲ Unit dimensions and coil connections may vary slightly from catalog. See factory certified prints for dimensions, quantity of coil connections, and piping configuration. Coil connections are 4" bevel for weld (BFW), also available as options. Other connection types such as grooved for mechanical coupling or flanged are also available as options.



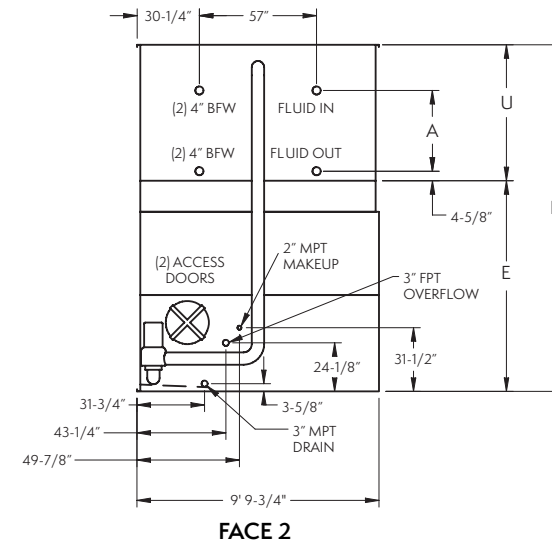
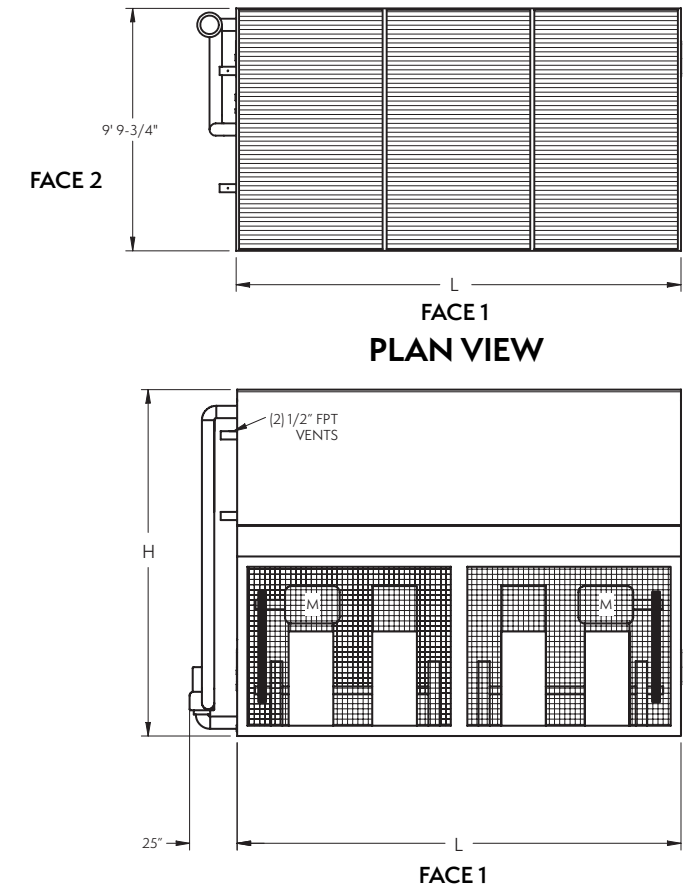
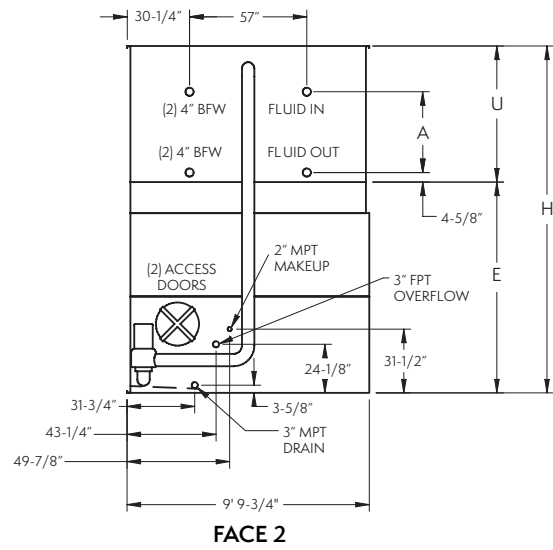
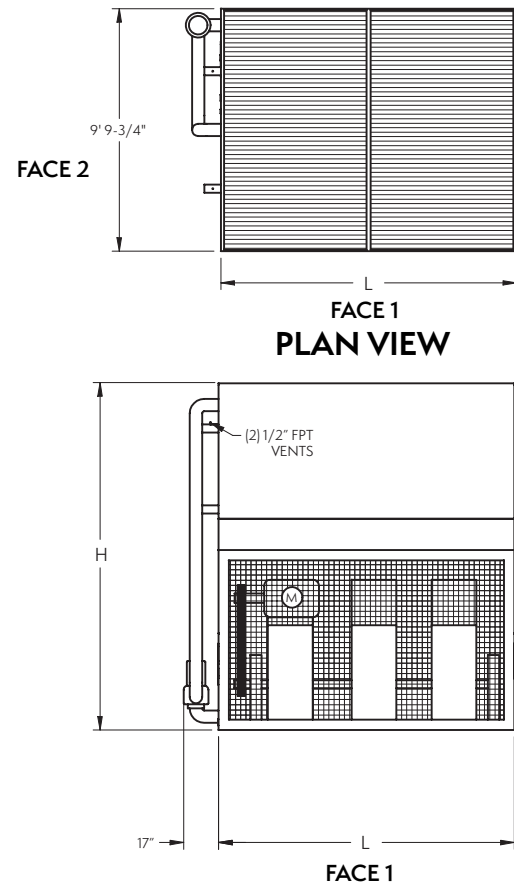

Model No. †	WEIGHTS (LBS)			FANS		SPRAY PUMP		Coil		REMOTE PUMP Δ					DIMENSIONS ▲				
	Shipping	Heaviest Section	Operating	HP	CFM	HP	GPM	Volume (Gallons)	Gallons Req'd**	Conn. Size	Operating Weight (lbs)	Height H	Length L	Lower E	Upper U	Coil A			
eco-LSWE 10-3M12	14,970	10,080	21,440	30	68,400	5	685	253	410	10"	19,190	12' 7-5/8"	11' 11-3/4"	8' 6-1/2"	4' 1-1/8"	1' 10-1/4"			
eco-LSWE 10-3N12	15,130	10,080	21,600	40	75,200	5	685	253	410	10"	19,350	12' 7-5/8"	11' 11-3/4"	8' 6-1/2"	4' 1-1/8"	1' 10-1/4"			
eco-LSWE 10-3O12	15,140	10,080	21,610	50	81,100	5	685	253	410	10"	19,360	12' 7-5/8"	11' 11-3/4"	8' 6-1/2"	4' 1-1/8"	1' 10-1/4"			
eco-LSWE 10-4M12	17,600	12,710	24,730	30	67,000	5	685	332	410	10"	22,660	13' 4-1/8"	11' 11-3/4"	8' 6-1/2"	4' 9-5/8"	2' 6-3/4"			
eco-LSWE 10-4N12	17,760	12,710	24,890	40	73,800	5	685	332	410	10"	22,820	13' 4-1/8"	11' 11-3/4"	8' 6-1/2"	4' 9-5/8"	2' 6-3/4"			
eco-LSWE 10-4O12	17,770	12,710	24,900	50	79,500	5	685	332	410	10"	22,830	13' 4-1/8"	11' 11-3/4"	8' 6-1/2"	4' 9-5/8"	2' 6-3/4"			
eco-LSWE 10-5M12	20,110	15,220	27,900	30	65,700	5	685	411	410	10"	26,000	14' 5/8"	11' 11-3/4"	8' 6-1/2"	5' 6-1/8"	3' 3-1/4"			
eco-LSWE 10-5N12	20,270	15,220	28,060	40	72,300	5	685	411	410	10"	26,160	14' 5/8"	11' 11-3/4"	8' 6-1/2"	5' 6-1/8"	3' 3-1/4"			
eco-LSWE 10-5O12	20,280	15,220	28,070	50	77,900	5	685	411	410	10"	26,170	14' 5/8"	11' 11-3/4"	8' 6-1/2"	5' 6-1/8"	3' 3-1/4"			
eco-LSWE 10-6M12	22,720	17,830	31,160	30	64,300	5	685	490	410	10"	29,440	14' 9-1/8"	11' 11-3/4"	8' 6-1/2"	6' 2-5/8"	3' 11-3/4"			
eco-LSWE 10-6N12	22,880	17,830	31,320	40	70,800	5	685	490	410	10"	29,600	14' 9-1/8"	11' 11-3/4"	8' 6-1/2"	6' 2-5/8"	3' 11-3/4"			
eco-LSWE 10-6O12	22,890	17,830	31,330	50	76,300	5	685	490	410	10"	29,610	14' 9-1/8"	11' 11-3/4"	8' 6-1/2"	6' 2-5/8"	3' 11-3/4"			
eco-LSWE 10-6P12	23,090	17,830	31,530	60	81,100	5	685	490	410	10"	29,810	14' 9-1/8"	11' 11-3/4"	8' 6-1/2"	6' 2-5/8"	3' 11-3/4"			

† Model Number will end in "-Z" for units with Series Flow piping configuration. Series Flow units may require additional coil connections and will require crossover piping. Model numbers will include "I" for units with Intake Attenuation, "D" for units with Discharge Attenuation, "F" for units with Full Sound Attenuation, "T" for units with a Tapered Discharge Hood, and "S" for units with an option that negates CTI Certification.

\* Heaviest section is the coil section.

\*\* Gallons shown is water in suspension in unit and piping. Allow for additional water in bottom of remote sump to cover pump suction and strainer during operation (12" would normally be sufficient).

Δ When a remote sump arrangement is selected, the spray pump, suction strainer and associated piping are omitted; the unit is provided with an oversized outlet to facilitate drainage to the remote sump.

▲ Unit dimensions and coil connections may vary slightly from catalog. See factory certified prints for dimensions, quantity of coil connections, and piping configuration. Coil connections are 4" bevel for weld (BFW), also available as options. Other connection types such as grooved for mechanical coupling or flanged are also available as options.

NOTE: The number of coil connections may increase based on design flow rate.

Model No. †	WEIGHTS (LBS)			FANS		SPRAY PUMP		Coil		REMOTE PUMP Δ					DIMENSIONS ▲				
	Shipping	Heaviest Section	Operating	HP	CFM	HP	GPM	Volume (Gallons)	Gallons Req'd**	Conn. Size	Operating Weight (lbs)	Height H	Length L	Lower E	Upper U	Coil A			
eco-LSWE 10-3K18	21,950	14,820	31,700	2	20	98,800	7.5	1,030	374	600	12"	28,190	12' 7-5/8"	18' 1/4"	8' 6-1/2"	4' 1-1/8"	1' 10-1/4"		
eco-LSWE 10-3L18	22,010	14,820	31,760	2	25	106,400	7.5	1,030	374	600	12"	28,250	12' 7-5/8"	18' 1/4"	8' 6-1/2"	4' 1-1/8"	1' 10-1/4"		
eco-LSWE 10-3M18	22,110	14,820	31,860	2	30	113,100	7.5	1,030	374	600	12"	28,350	12' 7-5/8"	18' 1/4"	8' 6-1/2"	4' 1-1/8"	1' 10-1/4"		
eco-LSWE 10-3N18	22,430	14,820	32,180	2	40	124,500	7.5	1,030	374	600	12"	28,670	12' 7-5/8"	18' 1/4"	8' 6-1/2"	4' 1-1/8"	1' 10-1/4"		
eco-LSWE 10-4L18	25,900	18,710	36,640	2	25	104,400	7.5	1,030	494	600	12"	33,350	13' 4-1/8"	18' 1/4"	8' 6-1/2"	4' 9-5/8"	2' 6-3/4"		
eco-LSWE 10-4M18	26,000	18,710	36,740	2	30	110,900	7.5	1,030	494	600	12"	33,450	13' 4-1/8"	18' 1/4"	8' 6-1/2"	4' 9-5/8"	2' 6-3/4"		
eco-LSWE 10-4N18	26,320	18,710	37,060	2	40	122,000	7.5	1,030	494	600	12"	33,770	13' 4-1/8"	18' 1/4"	8' 6-1/2"	4' 9-5/8"	2' 6-3/4"		
eco-LSWE 10-5L18	29,670	22,480	41,410	2	25	102,300	7.5	1,030	613	600	12"	38,380	14' 5/8"	18' 1/4"	8' 6-1/2"	5' 6-1/8"	3' 3-1/4"		
eco-LSWE 10-5M18	29,770	22,480	41,510	2	30	108,700	7.5	1,030	613	600	12"	38,480	14' 5/8"	18' 1/4"	8' 6-1/2"	5' 6-1/8"	3' 3-1/4"		
eco-LSWE 10-5N18	30,090	22,480	41,830	2	40	119,600	7.5	1,030	613	600	12"	38,800	14' 5/8"	18' 1/4"	8' 6-1/2"	5' 6-1/8"	3' 3-1/4"		
eco-LSWE 10-6L18	33,560	26,370	46,290	2	25	100,200	7.5	1,030	732	600	12"	43,510	14' 9-1/8"	18' 1/4"	8' 6-1/2"	6' 2-5/8"	3' 11-3/4"		
eco-LSWE 10-6M18	33,660	26,370	46,390	2	30	106,500	7.5	1,030	732	600	12"	43,610	14' 9-1/8"	18' 1/4"	8' 6-1/2"	6' 2-5/8"	3' 11-3/4"		
eco-LSWE 10-6N18	33,980	26,370	46,710	2	40	117,200	7.5	1,030	732	600	12"	43,930	14' 9-1/8"	18' 1/4"	8' 6-1/2"	6' 2-5/8"	3' 11-3/4"		

† Model Number will end in "-Z" for units with Series Flow piping configuration. Series Flow units may require additional coil connections and will require crossover piping. Model numbers will include "I" for units with Intake Attenuation, "D" for units with Discharge Attenuation, "F" for units with Full Sound Attenuation, "T" for units with a Tapered Discharge Hood, and "S" for units with an option that negates CTI Certification.

\* Heaviest section is the coil section.

\*\* Gallons shown is water in suspension in unit and piping. Allow for additional water in bottom of remote sump to cover pump suction and strainer during operation (12" would normally be sufficient).

Δ When a remote sump arrangement is selected, the spray pump, suction strainer and associated piping are omitted; the unit is provided with an oversized outlet to facilitate drainage to the remote sump.

▲ Unit dimensions and coil connections may vary slightly from catalog. See factory certified prints for dimensions, quantity of coil connections, and piping configuration. Coil connections are 4" bevel for weld (BFW), also available as options. Other connection types such as grooved for mechanical coupling or flanged are also available as options.

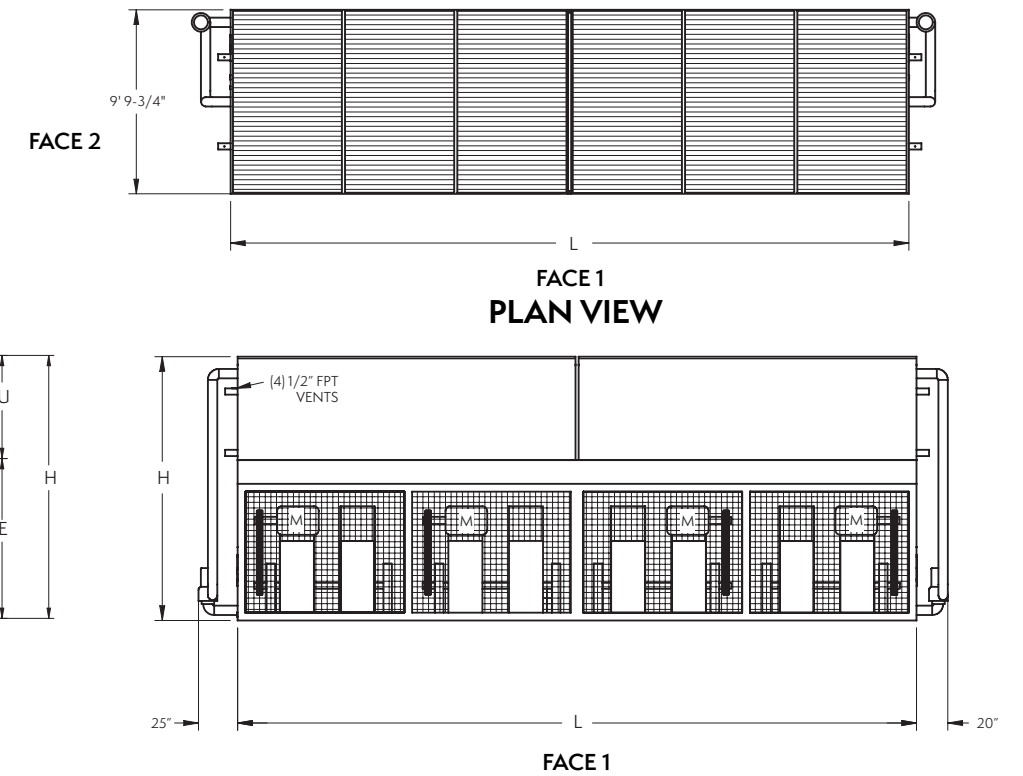
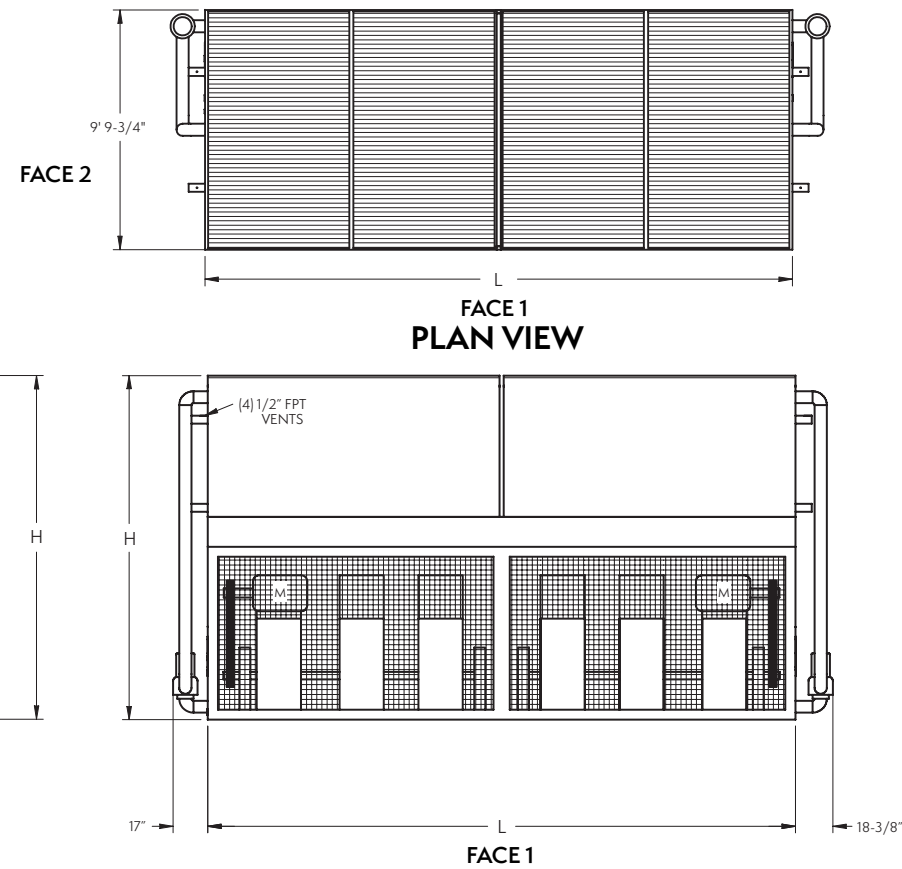

NOTE: The number of coil connections may increase based on design flow rate.

Model No. †	WEIGHTS (LBS)			FANS		SPRAY PUMP		Coil Volume (Gallons)	REMOTE PUMP Δ			DIMENSIONS ▲				
	Shipping	Heaviest Section*	Operating	HP	CFM	HP	GPM		Gallons Req'd**	Conn. Size	Operating Weight (lbs)	Height H	Length L	Lower E	Upper U	Coil A
eco-LSWE 10-3M24	29,360	10,080	42,460	[2] 30	136,700	[2] 5	1,370	507	820	[2] 10"	38,530	12' 7-5/8"	24' 1-1/4"	8' 6-1/2"	4' 1-1/8"	1' 10-1/4"
eco-LSWE 10-3N24	29,680	10,080	42,780	[2] 40	150,500	[2] 5	1,370	507	820	[2] 10"	39,170	12' 7-5/8"	24' 1-1/4"	8' 6-1/2"	4' 1-1/8"	1' 10-1/4"
eco-LSWE 10-3O24	29,700	10,080	42,800	[2] 50	162,100	[2] 5	1,370	507	820	[2] 10"	39,210	12' 7-5/8"	24' 1-1/4"	8' 6-1/2"	4' 1-1/8"	1' 10-1/4"
eco-LSWE 10-4M24	34,600	12,700	49,020	[2] 30	134,000	[2] 5	1,370	664	820	[2] 10"	45,420	13' 4-1/8"	24' 1-1/4"	8' 6-1/2"	4' 9-5/8"	2' 6-3/4"
eco-LSWE 10-4N24	34,920	12,700	49,340	[2] 40	147,500	[2] 5	1,370	664	820	[2] 10"	46,060	13' 4-1/8"	24' 1-1/4"	8' 6-1/2"	4' 9-5/8"	2' 6-3/4"
eco-LSWE 10-4O24	34,940	12,700	49,360	[2] 50	158,900	[2] 5	1,370	664	820	[2] 10"	46,100	13' 4-1/8"	24' 1-1/4"	8' 6-1/2"	4' 9-5/8"	2' 6-3/4"
eco-LSWE 10-5M24	39,640	15,220	55,380	[2] 30	131,400	[2] 5	1,370	822	820	[2] 10"	52,100	14' 5/8"	24' 1-1/4"	8' 6-1/2"	5' 6-1/8"	3' 3-1/4"
eco-LSWE 10-5N24	39,960	15,220	55,700	[2] 40	144,600	[2] 5	1,370	822	820	[2] 10"	52,740	14' 5/8"	24' 1-1/4"	8' 6-1/2"	5' 6-1/8"	3' 3-1/4"
eco-LSWE 10-5O24	39,980	15,220	55,720	[2] 50	155,800	[2] 5	1,370	822	820	[2] 10"	52,780	14' 5/8"	24' 1-1/4"	8' 6-1/2"	5' 6-1/8"	3' 3-1/4"
eco-LSWE 10-6M24	44,860	17,830	61,900	[2] 30	128,700	[2] 5	1,370	980	820	[2] 10"	58,950	14' 9-1/8"	24' 1-1/4"	8' 6-1/2"	6' 2-5/8"	3' 11-3/4"
eco-LSWE 10-6N24	45,180	17,830	62,220	[2] 40	141,600	[2] 5	1,370	980	820	[2] 10"	59,590	14' 9-1/8"	24' 1-1/4"	8' 6-1/2"	6' 2-5/8"	3' 11-3/4"
eco-LSWE 10-6O24	45,200	17,830	62,240	[2] 50	152,600	[2] 5	1,370	980	820	[2] 10"	59,630	14' 9-1/8"	24' 1-1/4"	8' 6-1/2"	6' 2-5/8"	3' 11-3/4"
eco-LSWE 10-6P24	45,600	17,830	62,640	[2] 60	162,100	[2] 5	1,370	980	820	[2] 10"	60,430	14' 9-1/8"	24' 1-1/4"	8' 6-1/2"	6' 2-5/8"	3' 11-3/4"

† Model Number will end in "-Z" for units with Series Flow piping configuration. Series Flow units may require additional coil connections and will require crossover piping. Model numbers will include "I" for units with Intake Attenuation, "D" for units with Discharge Attenuation, "F" for units with Full Sound Attenuation, "T" for units with a Tapered Discharge Hood, and "S" for units with an option that negates CTI Certification.  
 \* Heaviest section is the coil section.  
 \*\* Gallons shown is water in suspension in unit and piping. Allow for additional water in bottom of remote sump to cover pump suction and strainer during operation (12" would normally be sufficient).  
 Δ When a remote sump arrangement is selected, the spray pump, suction strainer and associated piping are omitted; the unit is provided with an oversized outlet to facilitate drainage to the remote sump.  
 ▲ Unit dimensions and coil connections may vary slightly from catalog. See factory certified prints for dimensions, quantity of coil connections, and piping configuration. Coil connections are 4" bevel for weld (BFW), also available as options. Other connection types such as grooved for mechanical coupling or flanged are also available as options.

Model No. †	WEIGHTS (LBS)			FANS		SPRAY PUMP		Coil Volume (Gallons)	REMOTE PUMP Δ			DIMENSIONS ▲				
	Shipping	Heaviest Section*	Operating	HP	CFM	HP	GPM		Gallons Req'd**	Conn. Size	Operating Weight (lbs)	Height H	Length L	Lower E	Upper U	Coil A
eco-LSWE 10-3K36	43,840	14,820	63,350	[4] 20	197,600	[2] 7.5	2,060	748	1,500	[2] 12"	57,890	12' 7-5/8"	36' 2-1/2"	8' 6-1/2"	4' 1-1/8"	1' 10-1/4"
eco-LSWE 10-3L36	43,960	14,820	63,470	[4] 25	212,900	[2] 7.5	2,060	748	1,500	[2] 12"	58,130	12' 7-5/8"	36' 2-1/2"	8' 6-1/2"	4' 1-1/8"	1' 10-1/4"
eco-LSWE 10-3M36	44,160	14,820	63,670	[4] 30	226,200	[2] 7.5	2,060	748	1,500	[2] 12"	58,530	12' 7-5/8"	36' 2-1/2"	8' 6-1/2"	4' 1-1/8"	1' 10-1/4"
eco-LSWE 10-3N36	44,800	15,160 ††	64,310	[4] 40	249,000	[2] 7.5	2,060	748	1,500	[2] 12"	59,810	12' 7-5/8"	36' 2-1/2"	8' 6-1/2"	4' 1-1/8"	1' 10-1/4"
eco-LSWE 10-4L36	51,740	18,710	73,230	[4] 25	208,700	[2] 7.5	2,060	987	1,500	[2] 12"	68,320	13' 4-1/8"	36' 2-1/2"	8' 6-1/2"	4' 9-5/8"	2' 6-3/4"
eco-LSWE 10-4M36	51,940	18,710	73,430	[4] 30	221,800	[2] 7.5	2,060	987	1,500	[2] 12"	68,720	13' 4-1/8"	36' 2-1/2"	8' 6-1/2"	4' 9-5/8"	2' 6-3/4"
eco-LSWE 10-4N36	52,580	18,710	74,070	[4] 40	244,100	[2] 7.5	2,060	987	1,500	[2] 12"	70,000	13' 4-1/8"	36' 2-1/2"	8' 6-1/2"	4' 9-5/8"	2' 6-3/4"
eco-LSWE 10-5L36	59,280	22,480	82,770	[4] 25	204,500	[2] 7.5	2,060	1,226	1,500	[2] 12"	78,380	14' 5/8"	36' 2-1/2"	8' 6-1/2"	5' 6-1/8"	3' 3-1/4"
eco-LSWE 10-5M36	59,480	22,480	82,970	[4] 30	217,300	[2] 7.5	2,060	1,226	1,500	[2] 12"	78,780	14' 5/8"	36' 2-1/2"	8' 6-1/2"	5' 6-1/8"	3' 3-1/4"
eco-LSWE 10-5N36	60,120	22,480	83,610	[4] 40	239,200	[2] 7.5	2,060	1,226	1,500	[2] 12"	80,060	14' 5/8"	36' 2-1/2"	8' 6-1/2"	5' 6-1/8"	3' 3-1/4"
eco-LSWE 10-6L36	67,040	26,360	92,510	[4] 25	200,400	[2] 7.5	2,060	1,464	1,500	[2] 12"	88,640	14' 9-1/8"	36' 2-1/2"	8' 6-1/2"	6' 2-5/8"	3' 11-3/4"
eco-LSWE 10-6M36	67,240	26,360	92,710	[4] 30	212,900	[2] 7.5	2,060	1,464	1,500	[2] 12"	89,040	14' 9-1/8"	36' 2-1/2"	8' 6-1/2"	6' 2-5/8"	3' 11-3/4"
eco-LSWE 10-6N36	67,880	26,360	93,350	[4] 40	234,300	[2] 7.5	2,060	1,464	1,500	[2] 12"	90,320	14' 9-1/8"	36' 2-1/2"	8' 6-1/2"	6' 2-5/8"	3' 11-3/4"

† Model Number will end in "-Z" for units with Series Flow piping configuration. Series Flow units may require additional coil connections and will require crossover piping. Model numbers will include "I" for units with Intake Attenuation, "D" for units with Discharge Attenuation, "F" for units with Full Sound Attenuation, "T" for units with a Tapered Discharge Hood, and "S" for units with an option that negates CTI Certification.  
 †† Heaviest section is the fan section.  
 \* Heaviest section is the coil section.  
 \*\* Gallons shown is water in suspension in unit and piping. Allow for additional water in bottom of remote sump to cover pump suction and strainer during operation (12" would normally be sufficient).  
 Δ When a remote sump arrangement is selected, the spray pump, suction strainer and associated piping are omitted; the unit is provided with an oversized outlet to facilitate drainage to the remote sump.  
 ▲ Unit dimensions and coil connections may vary slightly from catalog. See factory certified prints for dimensions, quantity of coil connections, and piping configuration. Coil connections are 4" bevel for weld (BFW), also available as options. Other connection types such as grooved for mechanical coupling or flanged are also available as options.



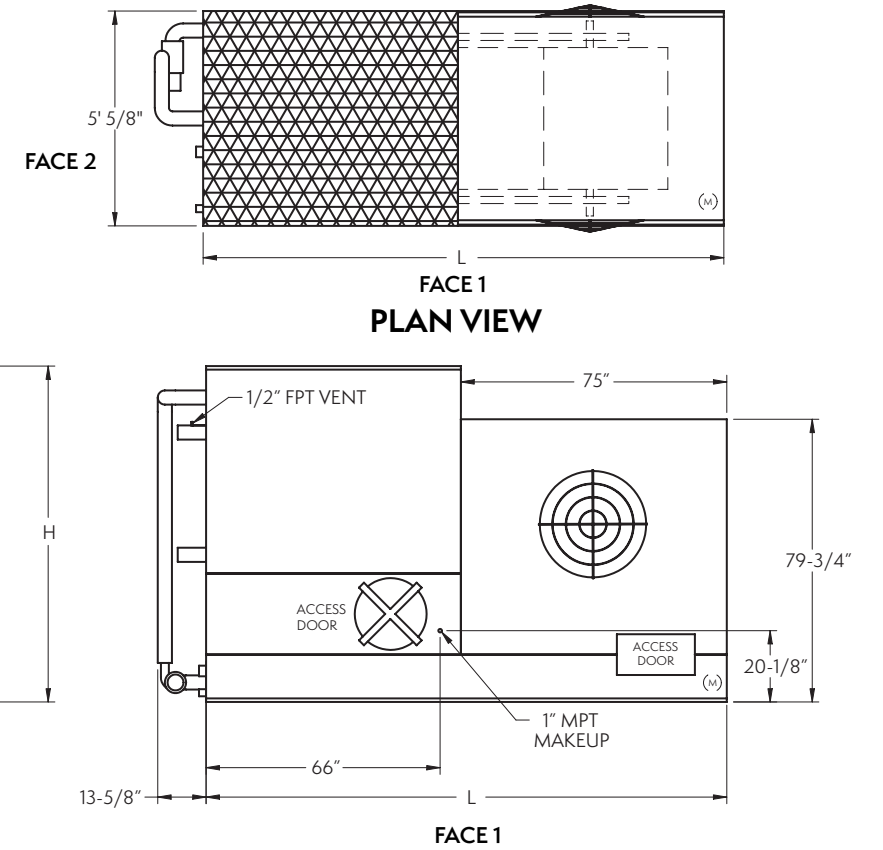
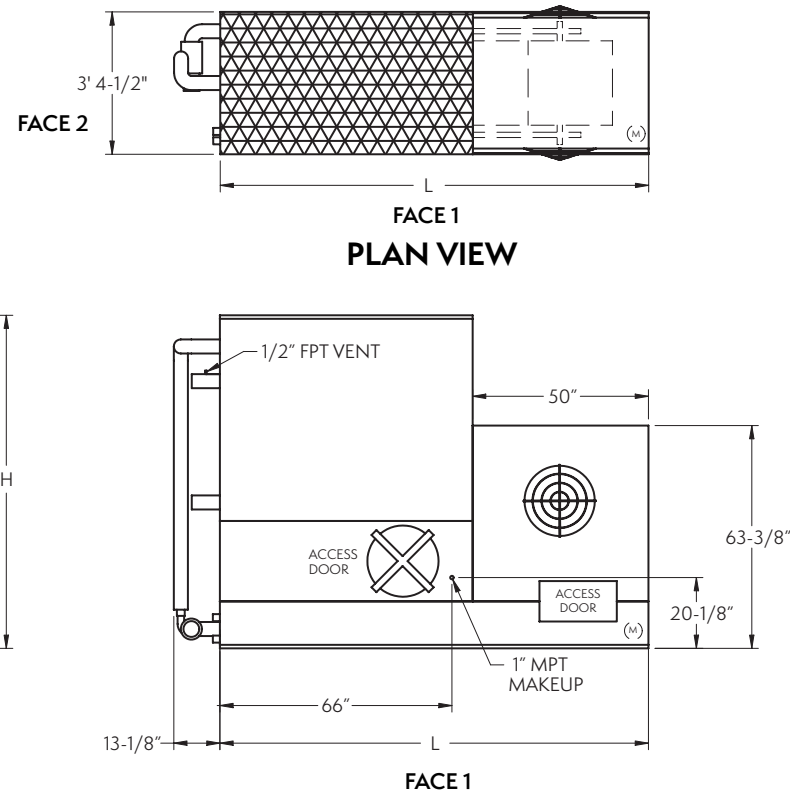

Model No. †	WEIGHTS (LBS)		FANS		SPRAY PUMP		Coil Volume (Gallons)	REMOTE PUMP Δ			DIMENSIONS ▲				
	Shipping	Operating	HP	CFM	HP	GPM		Gallons Req'd**	Conn. Size	Operating Weight (lbs)	Height H	Length L	Lower E	Upper U	Coil A
eco-LRWB 3-2D6	2,420	3,650	1.5	7,600	0.5	100	30	33	4"	2,760	6' 1/4"	10' 1-7/8"	3' 1/4"	3'	1'
eco-LRWB 3-2E6	2,420	3,650	2	8,300	0.5	100	30	33	4"	2,760	6' 1/4"	10' 1-7/8"	3' 1/4"	3'	1'
eco-LRWB 3-2F6	2,450	3,680	3	9,600	0.5	100	30	33	4"	2,790	6' 1/4"	10' 1-7/8"	3' 1/4"	3'	1'
eco-LRWB 3-2G6	2,460	3,690	5	11,300	0.5	100	30	33	4"	2,800	6' 1/4"	10' 1-7/8"	3' 1/4"	3'	1'
eco-LRWB 3-2H6	2,510	3,740	7.5	13,000	0.5	100	30	33	4"	2,850	6' 1/4"	10' 1-7/8"	3' 1/4"	3'	1'
eco-LRWB 3-3E6	2,820	4,150	2	8,200	0.5	100	43	33	4"	3,260	6' 7-3/4"	10' 1-7/8"	3' 1/4"	3' 7-1/2"	1' 7-1/2"
eco-LRWB 3-3F6	2,850	4,180	3	9,400	0.5	100	43	33	4"	3,290	6' 7-3/4"	10' 1-7/8"	3' 1/4"	3' 7-1/2"	1' 7-1/2"
eco-LRWB 3-3G6	2,860	4,190	5	11,100	0.5	100	43	33	4"	3,300	6' 7-3/4"	10' 1-7/8"	3' 1/4"	3' 7-1/2"	1' 7-1/2"
eco-LRWB 3-3H6	2,910	4,240	7.5	12,700	0.5	100	43	33	4"	3,350	6' 7-3/4"	10' 1-7/8"	3' 1/4"	3' 7-1/2"	1' 7-1/2"
eco-LRWB 3-4E6	3,250	4,680	2	8,000	0.5	100	55	33	4"	3,790	7' 3-1/4"	10' 1-7/8"	3' 1/4"	4' 3"	2' 3"
eco-LRWB 3-4F6	3,280	4,710	3	9,200	0.5	100	55	33	4"	3,820	7' 3-1/4"	10' 1-7/8"	3' 1/4"	4' 3"	2' 3"
eco-LRWB 3-4G6	3,290	4,720	5	10,900	0.5	100	55	33	4"	3,830	7' 3-1/4"	10' 1-7/8"	3' 1/4"	4' 3"	2' 3"
eco-LRWB 3-4H6	3,340	4,770	7.5	12,500	0.5	100	55	33	4"	3,880	7' 3-1/4"	10' 1-7/8"	3' 1/4"	4' 3"	2' 3"
eco-LRWB 3-5F6	3,730	5,270	3	9,000	0.5	100	67	33	4"	4,390	7' 10-3/4"	10' 1-7/8"	3' 1/4"	4' 10-1/2"	2' 10-1/2"
eco-LRWB 3-5G6	3,740	5,280	5	10,700	0.5	100	67	33	4"	4,400	7' 10-3/4"	10' 1-7/8"	3' 1/4"	4' 10-1/2"	2' 10-1/2"
eco-LRWB 3-5H6	3,790	5,330	7.5	12,200	0.5	100	67	33	4"	4,450	7' 10-3/4"	10' 1-7/8"	3' 1/4"	4' 10-1/2"	2' 10-1/2"
eco-LRWB 3-5I6	3,810	5,350	10	13,500	0.5	100	67	33	4"	4,470	7' 10-3/4"	10' 1-7/8"	3' 1/4"	4' 10-1/2"	2' 10-1/2"

NOTE: The number of coil connections may increase based on design flow rate.

Model No. †	WEIGHTS (LBS)		FANS		SPRAY PUMP		Coil Volume (Gallons)	REMOTE PUMP Δ			DIMENSIONS ▲				
	Shipping	Operating	HP	CFM	HP	GPM		Gallons Req'd**	Conn. Size	Operating Weight (lbs)	Height H	Length L	Lower E	Upper U	Coil A
eco-LRWB 5-2F6	3,660	5,780	3	13,800	1	160	47	120	6"	4,260	6' 1/4"	12' 2-7/8"	3' 1/4"	3'	1'
eco-LRWB 5-2G6	3,670	5,790	5	16,400	1	160	47	120	6"	4,270	6' 1/4"	12' 2-7/8"	3' 1/4"	3'	1'
eco-LRWB 5-2H6	3,720	5,840	7.5	18,700	1	160	47	120	6"	4,320	6' 1/4"	12' 2-7/8"	3' 1/4"	3'	1'
eco-LRWB 5-2I6	3,740	5,860	10	20,600	1	160	47	120	6"	4,340	6' 1/4"	12' 2-7/8"	3' 1/4"	3'	1'
eco-LRWB 5-3F6	4,290	6,570	3	13,500	1	160	66	120	6"	5,050	6' 7-3/4"	12' 2-7/8"	3' 1/4"	3' 7-1/2"	1' 7-1/2"
eco-LRWB 5-3G6	4,300	6,580	5	16,100	1	160	66	120	6"	5,060	6' 7-3/4"	12' 2-7/8"	3' 1/4"	3' 7-1/2"	1' 7-1/2"
eco-LRWB 5-3H6	4,350	6,630	7.5	18,400	1	160	66	120	6"	5,110	6' 7-3/4"	12' 2-7/8"	3' 1/4"	3' 7-1/2"	1' 7-1/2"
eco-LRWB 5-3I6	4,370	6,650	10	20,200	1	160	66	120	6"	5,130	6' 7-3/4"	12' 2-7/8"	3' 1/4"	3' 7-1/2"	1' 7-1/2"
eco-LRWB 5-4G6	4,950	7,390	5	15,700	1	160	85	120	6"	5,860	7' 3-1/4"	12' 2-7/8"	3' 1/4"	4' 3"	2' 3"
eco-LRWB 5-4H6	5,000	7,440	7.5	18,000	1	160	85	120	6"	5,910	7' 3-1/4"	12' 2-7/8"	3' 1/4"	4' 3"	2' 3"
eco-LRWB 5-4I6	5,020	7,460	10	19,800	1	160	85	120	6"	5,930	7' 3-1/4"	12' 2-7/8"	3' 1/4"	4' 3"	2' 3"
eco-LRWB 5-5G6	5,650	8,250	5	15,400	1	160	105	120	6"	6,720	7' 10-3/4"	12' 2-7/8"	3' 1/4"	4' 10-1/2"	2' 10-1/2"
eco-LRWB 5-5H6	5,700	8,300	7.5	17,700	1	160	105	120	6"	6,770	7' 10-3/4"	12' 2-7/8"	3' 1/4"	4' 10-1/2"	2' 10-1/2"
eco-LRWB 5-5I6	5,720	8,320	10	19,400	1	160	105	120	6"	6,790	7' 10-3/4"	12' 2-7/8"	3' 1/4"	4' 10-1/2"	2' 10-1/2"

† Model Number will end in "-Z" for units with Series Flow piping configuration. Series Flow units may require additional coil connections and will require crossover piping. Model numbers will include "I" for units with Intake Attenuation, "D" for units with Discharge Attenuation, "F" for units with Full Sound Attenuation, "T" for units with a Tapered Discharge Hood, and "S" for units with an option that negates CTI Certification.

\*\* Gallons shown is water in suspension in unit and piping. Allow for additional water in bottom of remote sump to cover pump suction and strainer during operation (12" would normally be sufficient).

Δ When a remote sump arrangement is selected, the spray pump, suction strainer and associated piping are omitted; the unit is provided with an oversized outlet to facilitate drainage to the remote sump.

▲ Unit dimensions and coil connections may vary slightly from catalog. See factory certified prints for dimensions, quantity of coil connections, and piping configuration. Coil connections are 4" bevel for weld (BFW), also available as options. Other connection types such as grooved for mechanical coupling or flanged are also available as options.

† Model Number will end in "-Z" for units with Series Flow piping configuration. Series Flow units may require additional coil connections and will require crossover piping. Model numbers will include "I" for units with Intake Attenuation, "D" for units with Discharge Attenuation, "F" for units with Full Sound Attenuation, "T" for units with a Tapered Discharge Hood, and "S" for units with an option that negates CTI Certification.

\*\* Gallons shown is water in suspension in unit and piping. Allow for additional water in bottom of remote sump to cover pump suction and strainer during operation (12" would normally be sufficient).

Δ When a remote sump arrangement is selected, the spray pump, suction strainer and associated piping are omitted; the unit is provided with an oversized outlet to facilitate drainage to the remote sump.

▲ Unit dimensions and coil connections may vary slightly from catalog. See factory certified prints for dimensions, quantity of coil connections, and piping configuration. Coil connections are 4" bevel for weld (BFW), also available as options. Other connection types such as grooved for mechanical coupling or flanged are also available as options.

# eco-LRWB 5-3H9 to 5-6K9

# eco-LRWB 5-3J12 to 5-6N12

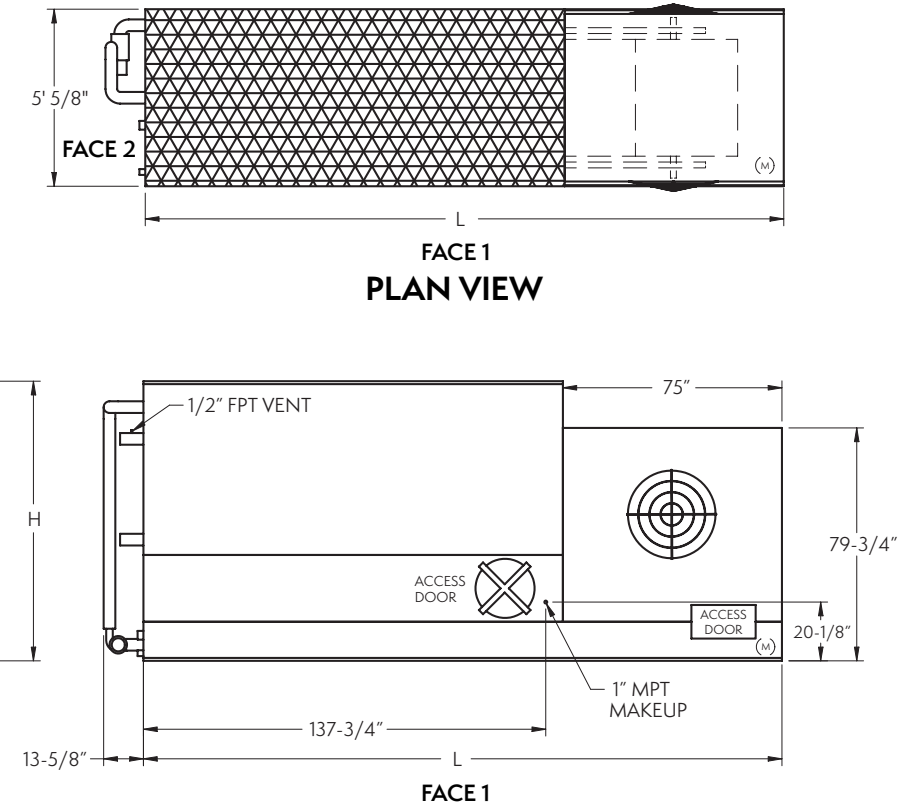
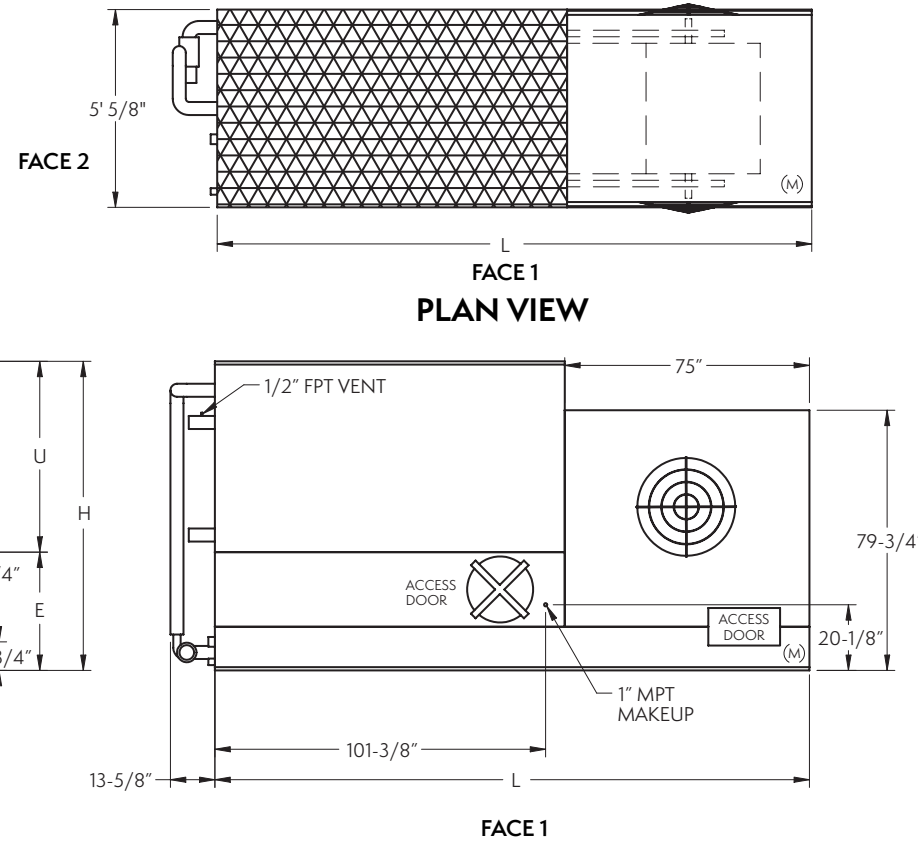

NOTE: The number of coil connections may increase based on design flow rate.

Model No. †	WEIGHTS (LBS)		FANS		SPRAY PUMP		Coil Volume (Gallons)	REMOTE PUMP Δ			DIMENSIONS ▲				
	Shipping	Operating	HP	CFM	HP	GPM		Gallons Req'd**	Conn. Size	Operating Weight (lbs)	Height H	Length L	Lower E	Upper U	Coil A
eco-LRWB 5-3H9	5,690	9,080	7.5	22,500	1.5	255	96	170	6"	6,880	6' 7-3/4"	15' 2-1/4"	3' 1/4"	3' 7-1/2"	1' 7-1/2"
eco-LRWB 5-3I9	5,710	9,100	10	24,700	1.5	255	96	170	6"	6,900	6' 7-3/4"	15' 2-1/4"	3' 1/4"	3' 7-1/2"	1' 7-1/2"
eco-LRWB 5-3J9	5,830	9,220	15	28,300	1.5	255	96	170	6"	7,020	6' 7-3/4"	15' 2-1/4"	3' 1/4"	3' 7-1/2"	1' 7-1/2"
eco-LRWB 5-3K9	5,890	9,280	20	31,100	1.5	255	96	170	6"	7,080	6' 7-3/4"	15' 2-1/4"	3' 1/4"	3' 7-1/2"	1' 7-1/2"
eco-LRWB 5-4I9	6,700	10,330	10	24,200	1.5	255	126	170	6"	8,130	7' 3-1/4"	15' 2-1/4"	3' 1/4"	4' 3"	2' 3"
eco-LRWB 5-4J9	6,820	10,450	15	27,700	1.5	255	126	170	6"	8,250	7' 3-1/4"	15' 2-1/4"	3' 1/4"	4' 3"	2' 3"
eco-LRWB 5-4K9	6,880	10,510	20	30,500	1.5	255	126	170	6"	8,310	7' 3-1/4"	15' 2-1/4"	3' 1/4"	4' 3"	2' 3"
eco-LRWB 5-5I9	7,720	11,600	10	23,800	1.5	255	155	170	6"	9,400	7' 10-3/4"	15' 2-1/4"	3' 1/4"	4' 10-1/2"	2' 10-1/2"
eco-LRWB 5-5J9	7,840	11,720	15	27,200	1.5	255	155	170	6"	9,520	7' 10-3/4"	15' 2-1/4"	3' 1/4"	4' 10-1/2"	2' 10-1/2"
eco-LRWB 5-5K9	7,900	11,780	20	29,900	1.5	255	155	170	6"	9,580	7' 10-3/4"	15' 2-1/4"	3' 1/4"	4' 10-1/2"	2' 10-1/2"
eco-LRWB 5-6I9	8,620	12,740	10	23,300	1.5	255	185	170	6"	10,540	8' 6-1/4"	15' 2-1/4"	3' 1/4"	5' 6"	3' 6"
eco-LRWB 5-6J9	8,740	12,860	15	26,600	1.5	255	185	170	6"	10,660	8' 6-1/4"	15' 2-1/4"	3' 1/4"	5' 6"	3' 6"
eco-LRWB 5-6K9	8,800	12,920	20	29,300	1.5	255	185	170	6"	10,720	8' 6-1/4"	15' 2-1/4"	3' 1/4"	5' 6"	3' 6"

† Model Number will end in "-Z" for units with Series Flow piping configuration. Series Flow units may require additional coil connections and will require crossover piping. Model numbers will include "I" for units with Intake Attenuation, "D" for units with Discharge Attenuation, "F" for units with Full Sound Attenuation, "T" for units with a Tapered Discharge Hood, and "S" for units with an option that negates CTI Certification.

\*\* Gallons shown is water in suspension in unit and piping. Allow for additional water in bottom of remote sump to cover pump suction and strainer during operation (12" would normally be sufficient).

Δ When a remote sump arrangement is selected, the spray pump, suction strainer and associated piping are omitted; the unit is provided with an oversized outlet to facilitate drainage to the remote sump.

▲ Unit dimensions and coil connections may vary slightly from catalog. See factory certified prints for dimensions, quantity of coil connections, and piping configuration. Coil connections are 4" bevel for weld (BFW), also available as options. Other connection types such as grooved for mechanical coupling or flanged are also available as options.

Model No. †	WEIGHTS (LBS)		FANS		SPRAY PUMP		Coil Volume (Gallons)	REMOTE PUMP Δ			DIMENSIONS ▲				
	Shipping	Operating	HP	CFM	HP	GPM		Gallons Req'd**	Conn. Size	Operating Weight (lbs)	Height H	Length L	Lower E	Upper U	Coil A
eco-LRWB 5-3J12	7,090	11,660	15	31,700	2	345	127	240	8"	8,760	6' 8-3/4"	18' 2-5/8"	3' 1/4"	3' 8-1/2"	1' 7-1/2"
eco-LRWB 5-3K12	7,150	11,720	20	34,900	2	345	127	240	8"	8,820	6' 8-3/4"	18' 2-5/8"	3' 1/4"	3' 8-1/2"	1' 7-1/2"
eco-LRWB 5-3L12	7,180	11,750	25	37,600	2	345	127	240	8"	8,850	6' 8-3/4"	18' 2-5/8"	3' 1/4"	3' 8-1/2"	1' 7-1/2"
eco-LRWB 5-3M12	7,230	11,800	30	39,900	2	345	127	240	8"	8,900	6' 8-3/4"	18' 2-5/8"	3' 1/4"	3' 8-1/2"	1' 7-1/2"
eco-LRWB 5-4J12	8,420	13,320	15	31,100	2	345	166	240	8"	10,420	7' 4-1/4"	18' 2-5/8"	3' 1/4"	4' 4"	2' 3"
eco-LRWB 5-4K12	8,480	13,380	20	34,200	2	345	166	240	8"	10,480	7' 4-1/4"	18' 2-5/8"	3' 1/4"	4' 4"	2' 3"
eco-LRWB 5-4L12	8,510	13,410	25	36,900	2	345	166	240	8"	10,510	7' 4-1/4"	18' 2-5/8"	3' 1/4"	4' 4"	2' 3"
eco-LRWB 5-4M12	8,560	13,460	30	39,200	2	345	166	240	8"	10,560	7' 4-1/4"	18' 2-5/8"	3' 1/4"	4' 4"	2' 3"
eco-LRWB 5-5K12	9,780	15,010	20	33,500	2	345	206	240	8"	12,110	7' 11-3/4"	18' 2-5/8"	3' 1/4"	4' 11-1/2"	2' 10-1/2"
eco-LRWB 5-5L12	9,810	15,040	25	36,100	2	345	206	240	8"	12,140	7' 11-3/4"	18' 2-5/8"	3' 1/4"	4' 11-1/2"	2' 10-1/2"
eco-LRWB 5-5M12	9,860	15,090	30	38,400	2	345	206	240	8"	12,190	7' 11-3/4"	18' 2-5/8"	3' 1/4"	4' 11-1/2"	2' 10-1/2"
eco-LRWB 5-5N12	10,020	15,250	40	42,200	2	345	206	240	8"	12,350	7' 11-3/4"	18' 2-5/8"	3' 1/4"	4' 11-1/2"	2' 10-1/2"
eco-LRWB 5-6L12	11,040	16,600	25	35,400	2	345	245	240	8"	13,700	8' 7-1/4"	18' 2-5/8"	3' 1/4"	5' 7"	3' 6"
eco-LRWB 5-6M12	11,090	16,650	30	37,600	2	345	245	240	8"	13,750	8' 7-1/4"	18' 2-5/8"	3' 1/4"	5' 7"	3' 6"
eco-LRWB 5-6N12	11,250	16,810	40	41,400	2	345	245	240	8"	13,910	8' 7-1/4"	18' 2-5/8"	3' 1/4"	5' 7"	3' 6"

† Model Number will end in "-Z" for units with Series Flow piping configuration. Series Flow units may require additional coil connections and will require crossover piping. Model numbers will include "I" for units with Intake Attenuation, "D" for units with Discharge Attenuation, "F" for units with Full Sound Attenuation, "T" for units with a Tapered Discharge Hood, and "S" for units with an option that negates CTI Certification.

\*\* Gallons shown is water in suspension in unit and piping. Allow for additional water in bottom of remote sump to cover pump suction and strainer during operation (12" would normally be sufficient).

Δ When a remote sump arrangement is selected, the spray pump, suction strainer and associated piping are omitted; the unit is provided with an oversized outlet to facilitate drainage to the remote sump.

▲ Unit dimensions and coil connections may vary slightly from catalog. See factory certified prints for dimensions, quantity of coil connections, and piping configuration. Coil connections are 4" bevel for weld (BFW), also available as options. Other connection types such as grooved for mechanical coupling or flanged are also available as options.











- World Headquarters  
Research & Development Center
- EVAPCO Manufacturing Facilities

## EVAPCO, Inc. — World Headquarters & Research / Development Center

P.O. Box 1300 • Westminster, MD 21158 USA  
410.756.2600 • [marketing@evapco.com](mailto:marketing@evapco.com) • [evapco.com](http://evapco.com)

### North America

- EVAPCO, Inc.**  
**World Headquarters**  
Westminster, MD USA  
410.756.2600  
[marketing@evapco.com](mailto:marketing@evapco.com)
- EVAPCO East**  
Taneytown, MD USA
- EVAPCO East**  
Key Building  
Taneytown, MD USA
- EVAPCO Midwest**  
Greenup, IL USA  
217.923.3431  
[evapcomw@evapcomw.com](mailto:evapcomw@evapcomw.com)
- Evapcold Manufacturing**  
Greenup, IL USA
- EVAPCO West**  
Madera, CA USA  
559.673.2207  
[contact@evapcowest.com](mailto:contact@evapcowest.com)
- EVAPCO Alcoil, Inc.**  
York, PA USA  
717.347.7500  
[info@evapco-alcoil.com](mailto:info@evapco-alcoil.com)
- EVAPCO Iowa**  
Lake View, IA USA
- EVAPCO Iowa**  
Sales & Engineering  
Medford, MN USA  
507.446.8005  
[evapcomn@evapcomn.com](mailto:evapcomn@evapcomn.com)

- EVAPCO LMP ULC**  
Laval, Quebec, Canada  
450.629.9864  
[info@evapcolmp.ca](mailto:info@evapcolmp.ca)
- EVAPCO Select Technologies, Inc.**  
Belmont, MI USA  
844.785.9506  
[emarketing@evapcoselect.com](mailto:emarketing@evapcoselect.com)
- Refrigeration Vessels & Systems Corporation**  
Bryan, TX USA  
979.778.0095  
[rvs@rvscorp.com](mailto:rvs@rvscorp.com)
- Tower Components, Inc.**  
Ramseur, NC USA  
336.824.2102  
[mail@towercomponentsinc.com](mailto:mail@towercomponentsinc.com)
- EvapTech, Inc.**  
Edwardsville, KS USA  
913.322.5165  
[marketing@evaptech.com](mailto:marketing@evaptech.com)
- EVAPCO Dry Cooling, Inc.**  
Bridgewater, NJ USA  
908.379.2665  
[info@evapcodc.com](mailto:info@evapcodc.com)
- EVAPCO Dry Cooling, Inc.**  
Littleton, CO USA  
908.895.3236  
[info@evapcodc.com](mailto:info@evapcodc.com)

### Asia Pacific

- EVAPCO Asia Pacific Headquarters**  
Baoshan Industrial Zone Shanghai, P.R. China  
(86) 21.6687.7786  
[marketing@evapcochina.com](mailto:marketing@evapcochina.com)
- EVAPCO (Shanghai) Refrigeration Equipment Co., Ltd.**  
Baoshan Industrial Zone, Shanghai, P.R. China
- EVAPCO (Beijing) Refrigeration Equipment Co., Ltd.**  
Huairou District, Beijing, P.R. China  
(86) 10.6166.7238  
[marketing@evapcochina.com](mailto:marketing@evapcochina.com)
- (Jiaxing) Company, Ltd.**  
Jiaxing, Zhejiang, P.R. China  
(86) 573.8311.9379  
[info@evapcochina.com](mailto:info@evapcochina.com)
- EVAPCO Australia (Pty.) Ltd.**  
Riverstone, NSW, Australia  
(61) 02.9627.3322  
[sales@evapco.com.au](mailto:sales@evapco.com.au)
- EvapTech (Shanghai) Cooling Tower Co., Ltd**  
Baoshan District, Shanghai, P.R. China.  
Tel: (86) 21.6478.0265
- EvapTech Asia Pacific Sdn. Bhd.**  
Puchong, Selangor, Malaysia  
(60) 3.8070.7255  
[marketing-ap@evaptech.com](mailto:marketing-ap@evaptech.com)

### EVAPCO Air Cooling Systems

### Europe | Middle East | Africa

- EVAPCO Europe EMENA Headquarters**  
Tongeren, Belgium  
(32) 12.39.50.29  
[evapco.europe@evapco.be](mailto:evapco.europe@evapco.be)
- EVAPCO Europe BV**  
Tongeren, Belgium
- EVAPCO Europe, S.r.l.**  
Milan, Italy  
(39) 02.939.9041  
[evapcoeuropa@evapco.it](mailto:evapcoeuropa@evapco.it)
- EVAPCO Europe, S.r.l.**  
Sondrio, Italy
- EVAPCO Europe A/S**  
Aabybro, Denmark  
(45) 9824.4999  
[info@evapco.dk](mailto:info@evapco.dk)
- EVAPCO Europe GmbH**  
Meerbusch, Germany  
(49) 2159.69560  
[info@evapco.de](mailto:info@evapco.de)
- EVAPCO Middle East DMCC**  
Dubai, United Arab Emirates  
(971) 56.991.6584  
[info@evapco.ae](mailto:info@evapco.ae)
- Evap Egypt Engineering Industries Co.**  
*A licensed manufacturer of EVAPCO, Inc.*  
Nasr City, Cairo, Egypt  
(20) 10.05.432198  
[evapco@tiba-group.com](mailto:evapco@tiba-group.com)
- EVAPCO S.A. (Pty.) Ltd.**  
*A licensed manufacturer of EVAPCO, Inc.*  
Isando, South Africa  
(27) 11.392.6630  
[evapco@evapco.co.za](mailto:evapco@evapco.co.za)

### South America

- EVAPCO Brasil**  
*Equipamentos Industriais Ltda.*  
Indaiatuba, São Paulo, Brazil  
(55) 11.5681.2000  
[vendas@evapco.com.br](mailto:vendas@evapco.com.br)
- FanTR Technology Resources**  
Itu, São Paulo, Brazil  
(55) 11.4025.1670  
[fantr@fantr.com](mailto:fantr@fantr.com)