



for LIFE

CLOSED CIRCUIT COOLERS



LSWE LRWB



† Mark owned by the Cooling Technology Institute

FORCED DRAFT

Most Energy Efficient Axial Fan Closed Circuit Cooler on the Market



EVAPCO is more than a name.

It is a pledge to make everyday life easier, more comfortable, more reliable, and more sustainable for people everywhere. How do we fulfill that promise? It is simple.

We never stop innovating.

At EVAPCO, we do not just talk about innovation, It is ingrained in our workflow. Guided by our annually developed R&D plans, we set out to find groundbreaking solutions that transform the way the world works for the better. It is why we have more than 200 active patents worldwide.

We craft exceptionally built solutions.

As an employee-owned company, we take pride in our work. We are proud to be one of the most experienced teams of engineers and craftsmen in the industry. This translates into solutions that are always exceptionally built. EVAPCO has an unwavering commitment to provide “best in class” heat transfer solutions and services.

We guarantee performance.

Every EVAPCO solution is put through rigorous research and testing to ensure maximum efficiency and reliability. But we do not stop there. EVAPCO is an industry leader in independent, third-party performance certifications. These certifications guarantee our performance metrics—so that you can plan your projects with complete peace of mind.

We protect the environment.

Innovation and environmental sustainability go hand-in-hand at EVAPCO. EVAPCO’s industrial heat transfer equipment not only conserves natural resources and helps reduce noise pollution, they also feature recycled steel content in their construction. Our stainless steel units are constructed of panels that contain up to 75% recycled content; over 80% in galvanized units construction. From sound reduction to water conservation to chemical elimination, we are constantly developing new technologies that deliver the ultimate operating advantages for our clients—and protect the planet for every generation that comes after us.



Get to Know EVAPCO

- The global innovator in heat transfer solutions
- Serving the commercial HVAC, Industrial Refrigeration, Power Generation, and Industrial Process markets
- Founded in 1976
- Employee-owned
- 33 locations in 14 countries
- More than 200+ sales offices worldwide

Learn More Now

Visit evapco.com to download product catalogs, view complete product specifications, and more.

Table of Contents

Corporate	1
LSWE and LRWB Principle of Operation	3
Application Versatility	4
LSWE Design and Construction Features	5-6
LRWB Design and Construction Features	7-8
Innovative Design Features	9-10
Water Treatment Solutions	11-12
LSWE Stainless Steel Options	13
LRWB Stainless Steel Options	14
Coil Connection Options	15
Low Sound Solutions	16
LSWE Discharge & Intake Attenuation	17
LRWB Discharge & Intake Attenuation	18
Freeze Protection Options	19-20
Heat Loss & Discharge Hood Dimensions	21
Steel Support	22
Specific Design Features	23
General Information	24
Engineering Data	25-41

Low Sound and Low Rise Forced Draft Closed Circuit Coolers

EVAPCO's LSWE/LRWB Closed Circuit Coolers utilize Evapco's Thermal-Pak® coil design now featuring the revolutionary **CROSSCOOL** Internal Tube Enhancement. The **CROSSCOOL** Internal Tube Enhancement increases the internal heat transfer coefficient of the coil and thus increases the cooling capacity of the unit. This new and improved series of coolers is the ideal solution for indoor application, confined layouts, low sound requirements and direct replacements to name a few. Both models are designed for easy maintenance and long, trouble free operation.



LSWE

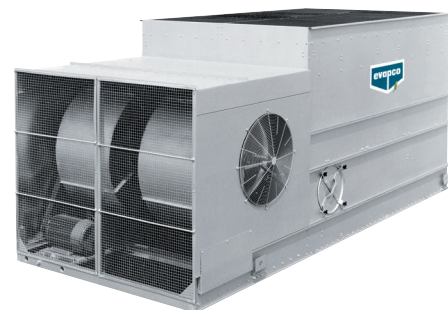

LRWB

The standard for forced draft centrifugal fan designs, Now more efficient than ever.

With the fan section located beside the heat transfer casing, this unit satisfies even the strictest of height requirements in a unitary, compact design.

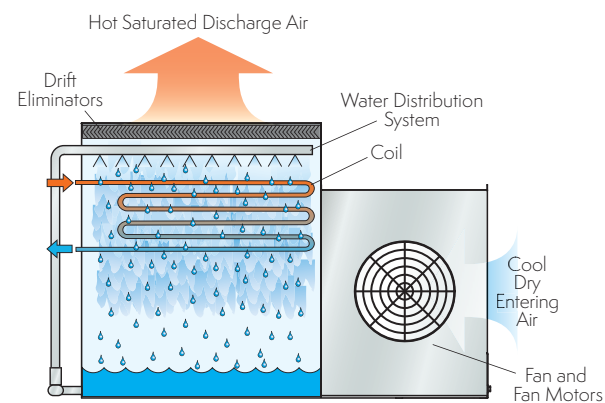
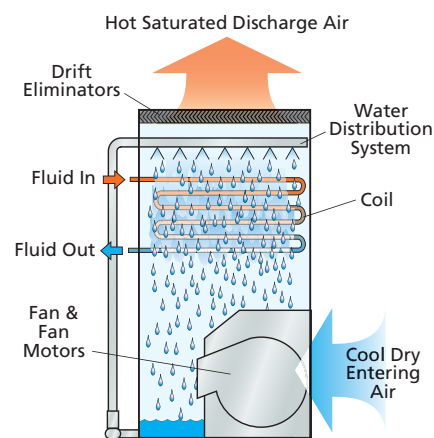

Principle of Operation

The process fluid is circulated through the coil of the closed circuit cooler. Heat from the process fluid is dissipated through the coil tubes to the water cascading downward over the tubes. Simultaneously air is blown through the unit by the fans and travels upward over the coil opposite the water flow. A small portion of the water is evaporated which removes the heat. The warm moist air is forced to the top of the closed circuit cooler by the fan and is discharged to the atmosphere. The remaining water falls to the sump at the bottom of the cooler where it is recirculated by the pump up through the water distribution system and back down over the coils.

Centrifugal units are recommended for a wide range of installations. They are quiet, can easily be hidden, and are an excellent solution for installations where sound is sensitive, and when the unit must handle external static pressure.

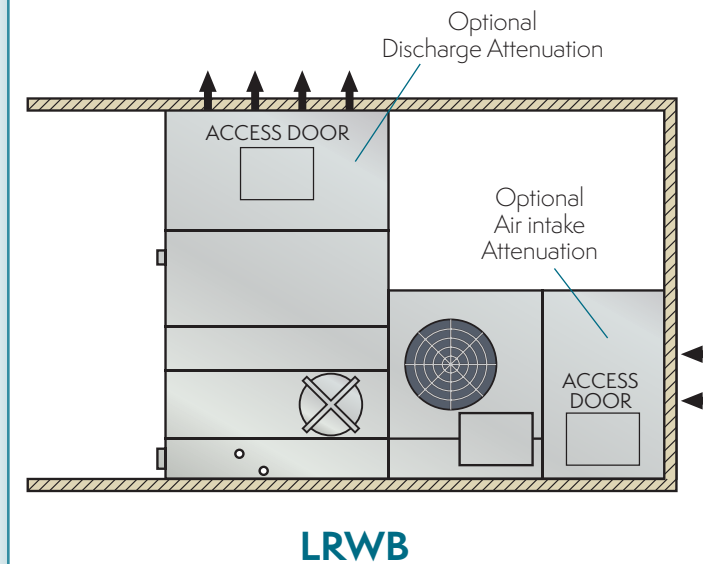

LRWB

Note: LRWB Shown Ducted on Both Inlet and Discharge

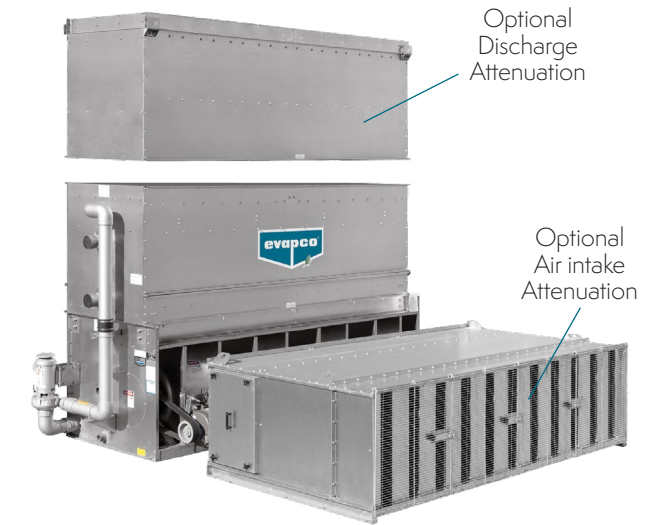

LSWE

Very Quiet Operation

Centrifugal fan units operate at low sound levels which make this design preferred for installations with external static pressure where noise is a concern. Additionally, since the sound from the fans is directional, single sided air entry models can be turned away from critical areas avoiding a sound problem. When even quieter operation is necessary, centrifugal fan models can be equipped with optional sound attenuation packages. See the Sound Reducing Options section of this catalog or consult the factory for details.

In addition, the LRWB features a specially engineered fan enclosure and drive system that is designed to offer very quiet operation without the high cost of external attenuation packages. The LRWB fan system was developed through hundreds of hours of laboratory tests resulting in the lowest standardized sound levels available in the industry. In fact, the sound level of the LRWB on average is 2 dBA quieter than competitors' similar models.

Indoor Installation

All LSWE and LRWB closed circuit coolers can be installed indoors where they normally require ductwork to and from the unit. The design of the ductwork should be symmetrical to provide even air distribution across both intake and discharge openings. Guidelines for ducted applications:

- 1) The static pressure loss imposed by the ductwork must not exceed 1/2". The fan motor size must be increased for ESP up to 1/2".
- 2) For ducted installations, the solid bottom panel option must be ordered. On the LRWB, blank off plates will also be provided in lieu of the side air inlet screens with this option.
- 3) **NOTE:** Access doors must be located in the ductwork (by others) for service to the fan drive components and water distribution system.

Drawings are available showing recommended ductwork connections. See EVAPCO's layout guidelines for additional information.

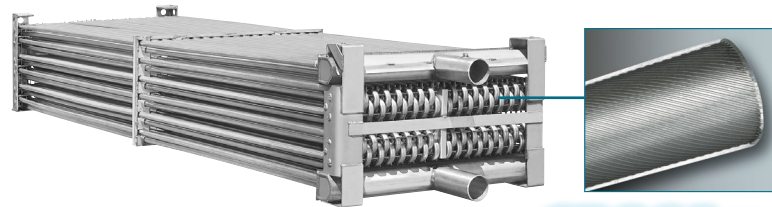

CROSSCOOL™
INTERNAL TUBE ENHANCEMENT

Galvanized Steel Coil Elliptical Thermal-Pak® COIL Construction Featuring CROSSCOOL™ Internal Tube Enhancement Technology

- Internal tube enhancement increases fluid turbulence providing **additional evaporative capacity**
- Elliptical return bends allows for more circuits per coil bundle increasing maximum capacity per footprint
- Coil located in the airstream increasing dry bulb switchover temperature



Optional Factory Mounted Water Treatment Systems

The LSWE is available with multiple water treatment options, including a **Pulse~Pure®** (not shown) non-chemical or a **Smart Shield®** (not shown) solid chemical water treatment system. EVAPCO offers a number of environmentally sensitive alternatives for treating water in evaporative cooled equipment. Each system includes all components required for an effective water treatment system; factory mounted and wired. Refer to pages 11-12 for more information.



The EVAPCO Performance Guarantee

Every LSWE product is rigorously thermal performance tested by EVAPCO and then independently certified by the Cooling Technology Institute (CTI) so you know you're getting a solution that's guaranteed to get the job done.

*Mark owned by the Cooling Technology Institute



Zero Maintenance PVC Spray Distribution Header with ZM®II Nozzles

- Fixed position nozzles require zero maintenance
- Large orifice nozzles prevent clogging

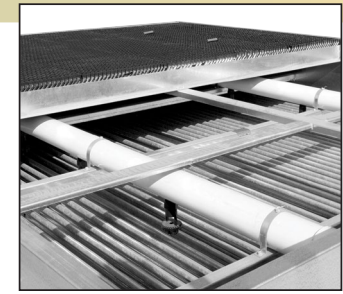

Easy Field Assembly

- Ensures easy assembly and fewer fasteners
- Incorporates self-guiding channels to guide the coil casing section into position improving the quality of the field seam

Clean Pan Design

- Sloped design allows water to drain completely from cold water basin
- Easier removal of dirt and debris



Totally Enclosed Fan Motors

- Assures long life
- All normal maintenance can be performed quickly from outside the unit
- If required, motor may be easily removed
- Motors are now located outboard on multi-motor units for even easier drive system access
- Premium efficient inverter-ready motors are standard

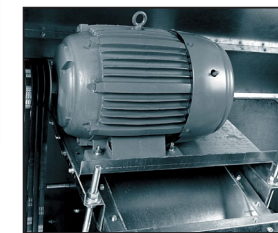

**Exclusive 5 Year
Motor and Drive
Warranty**

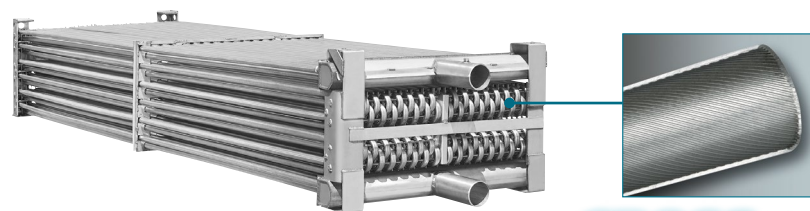

CROSSCOOL™
INTERNAL TUBE ENHANCEMENT

Galvanized Steel Coil Elliptical Thermal-Pak® COIL Construction Featuring CROSSCOOL™ Internal Tube Enhancement Technology

- Internal tube enhancement increases fluid turbulence providing **additional evaporative capacity**
- Elliptical return bends allows for more circuits per coil bundle increasing maximum capacity per footprint
- Coil located in the airstream increasing dry bulb switchover temperature

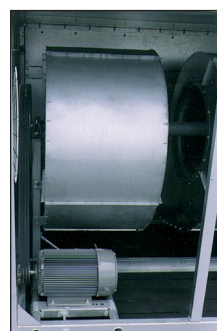

Easy to Service Motor & Drive System

- Belt tensioning and bearing lubrication can be performed from outside the unit
- Locking mechanism can also be used as a wrench to adjust the belts
- Motor is fully accessible by removing one inlet screen
- Split fan housings allow removal of all mechanical equipment through the end of the unit



**Exclusive 5 Year
Motor and Drive
Warranty**

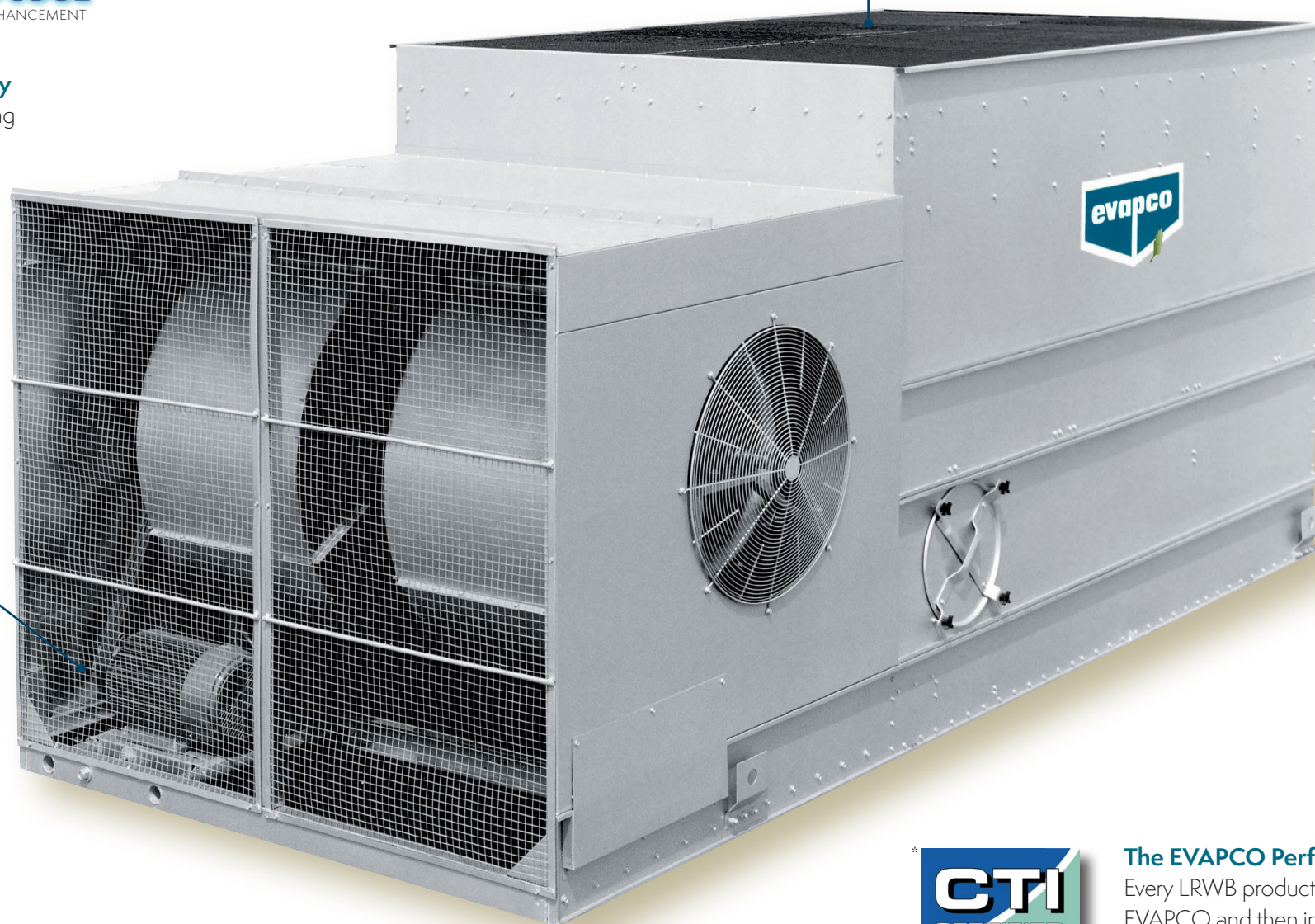

Zero Maintenance PVC Spray Distribution Header with ZM®II Nozzles

- Fixed position nozzles require zero maintenance
- Large orifice nozzles prevent clogging

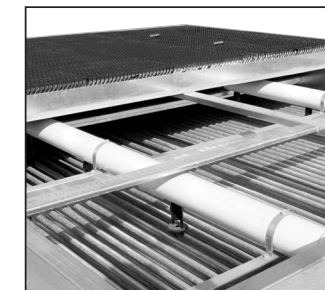

Optional Factory Mounted Water Treatment Systems

The LRWB is available with multiple water treatment options, including a **Pulse-Pure®** (not shown) non-chemical or a **Smart Shield®** (not shown) solid chemical water treatment system. EVAPCO offers a number of environmentally sensitive alternatives for treating water in evaporative cooled equipment. Each system includes all components required for an effective water treatment system; factory mounted and wired. Refer to pages 11-12 for more information.



The EVAPCO Performance Guarantee

Every LRWB product is rigorously thermal performance tested by EVAPCO and then independently certified by the Cooling Technology Institute (CTI) so you know you're getting a solution that's guaranteed to get the job done.

*Mark owned by the Cooling Technology Institute

Elliptical Thermal-Pak® Heat Transfer Coil

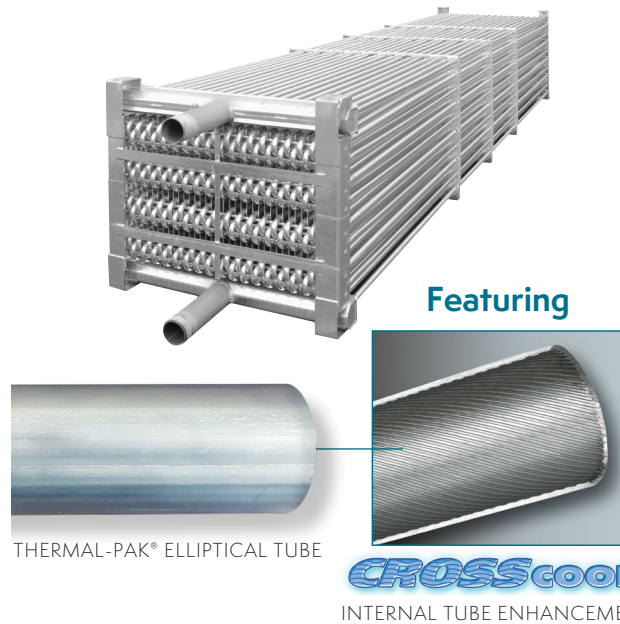

Galvanized steel elliptical Thermal-Pak® coil featuring CROSSCOOL™ Internal Tube Enhancement Technology

- Internal Tube Enhancement provides additional evaporative capacity
- Elliptical tube design allows for more circuits per coil bundle increasing maximum capacity per footprint
- Elliptical tube design results in lower airflow resistance than typical round tube designs

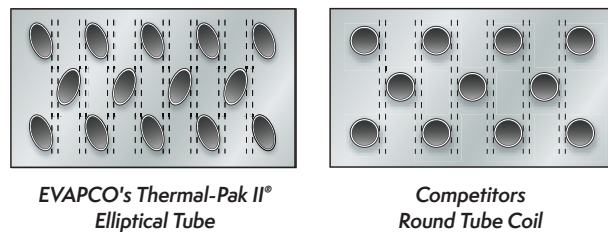

The LSWE and LRWB closed circuit coolers utilize EVAPCO's Thermal-Pak® coil design. The elliptical tube design allows for closer tube spacing, resulting in greater surface area per plan area than round-tube coil designs.

In addition, the Thermal-Pak® design has lower resistance to airflow and also permits greater water loading making the Thermal-Pak® coil the most efficient design available.

The Thermal-Pak® coil design also features EVAPCO's Internal Tube Enhancement Technology. This increases fluid turbulence through the coil, further increasing the evaporative capacity.

The coils are manufactured from high quality steel tubing in accordance with the most stringent quality control procedures. Each circuit is inspected to ensure the material quality and then tested before being assembled into a coil. The coil shall have design pressure of 300 psi and shall be in compliance with ANSI/ASME B31.5, Refrigeration Piping and Heat Transfer Components. The coil assembly shall be strength tested in accordance with ANSI/ASME B31.5 and subsequently leak tested underwater.

To protect the coil against corrosion, it is placed in a heavy steel frame and then the entire assembly is dipped into molten zinc (hot-dipped galvanized) at a temperature of approximately 800°F.

NOTE: Closed circuit coolers should only be used on sealed, pressurized systems. Continual aeration of the water in an open system can cause corrosion inside the tubes of the coil leading to premature failure.

Stainless Steel Coil Option

Evapco offers the optional TITAN COIL. Constructed with type 304L Stainless Steel, the TITAN COIL is manufactured using EVAPCO's elliptical tube Thermal-Pak® design upgraded to Xtra Tough construction featuring: Xtra Durability, Xtra Corrosion Resistance, and an Xtra long **5 Year Coil Warranty** as standard.

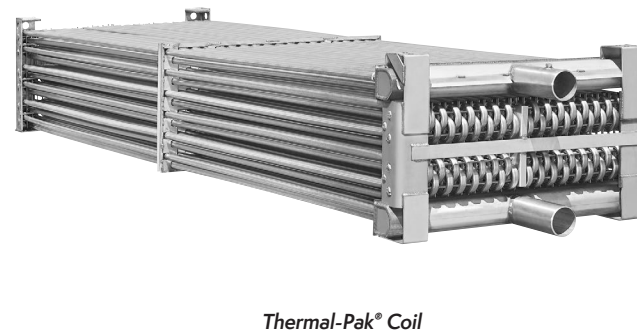

Fan Motor Mount

TEFC fan motors are mounted in a convenient open area for ease of belt tensioning, motor lubrication and electrical connection. The motor base is designed for easy adjustment and is locked into position to maintain proper belt tension.

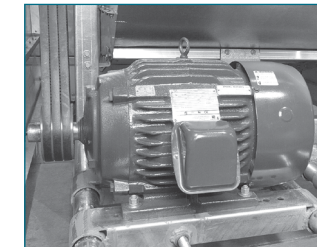
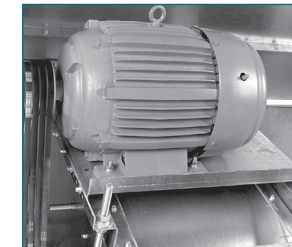

Fan Access-Split Housing

Another unique feature of the LRWB closed circuit cooler is the split fan housing. The split fan housing on the LRWB allows quick removal of the fans from the front end of the unit. This feature allows fan removal when units are placed side by side where space is minimal.

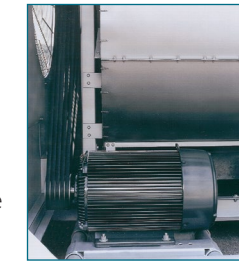

Mechanical Drive System Access

The LSWE and LRWB mechanical drive systems are easy to maintain. Bearing lubrication and belt adjustment can be performed from outside the unit. There is no need to remove fan screens to maintain important drive components. In addition, the locking mechanism used to maintain belt tension can also work as a wrench to adjust the belt.

Centrifugal Fan Assembly

Fans on LSWE and LRWB closed circuit coolers are of the forward curved centrifugal design with hot-dip galvanized steel construction. All fans are statically and dynamically balanced and are mounted in a hot-dip galvanized steel housing.

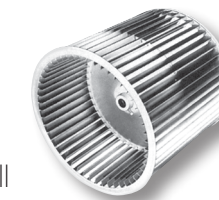

Maintenance Free ZM®II Spray Nozzle Water Distribution System

EVAPCO's Zero Maintenance ZM®II spray nozzle remains clog-free while providing even and constant water distribution for reliable, scale-free evaporative cooling under all operating conditions.

The heavy duty nylon ZM®II spray nozzles have a 1-5/16" diameter opening and a 1-1/2" splash plate clearance. Furthermore, the fixed position ZM®II nozzles are mounted in corrosion-free PVC water distribution pipes that have threaded end caps. Together, these elements combine to provide unequalled coil coverage and scale prevention, and make the industry's best performing non-corrosive, maintenance-free water distribution system.



Efficient Drift Eliminators

The LSWE and LRWB are provided with an efficient drift eliminator system that effectively reduces entrained water droplets from the air discharge to less than 0.001% of the spray water flow rate.

The eliminators are constructed of non-corrosive PVC with a multi-pass design for maximum drift reduction. They are assembled in modular sections for easy removal and access to the water distribution system.

In addition to reducing drift, the eliminators also function as effective debris screens which protect the spray system from sunlight and debris.

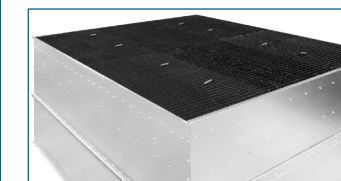



Our Industry-Leading Approach

To enhance passivation and minimize the formation of *white rust*, we've developed a two-step process that produces visible results. Even in applications requiring immediate heat load, we can provide practical solutions for galvanized steel equipment.

The EVAPCO Pass-Protect® process is a combination of:

Step 1: Passiv-Assist® Factory Applied Pretreatment

Step 2: Field Passivation

Experience a custom passivation plan that promotes the formation of a passive oxide layer, eliminating the need to feed white rust inhibitors for the life of the unit.



Learn more about this solution at evapco.com.



Engineered to Improve Water Efficiency

The EVAPCO Water Saver™ utilizes capacitive deionization technology to reduce dissolved ion concentration, thus lowering the makeup water conductivity prior to use in an evaporative cooling system. Makeup water entering the Water Saver passes through individual cylinders which contain oppositely charged supercapacitors. Dissolved ions (except silica) are removed from the water as they are absorbed onto the charged capacitors. A typical 50% ion reduction allows the operating cycles of concentration to be safely doubled without an increase in scale or corrosion potential.



View the Water Saver video and Mechanical Specifications at evapco.com to learn more.



Pretreatment System for Evaporative Cooling Equipment



Pulse~Pure® Non-Chemical Water Treatment System

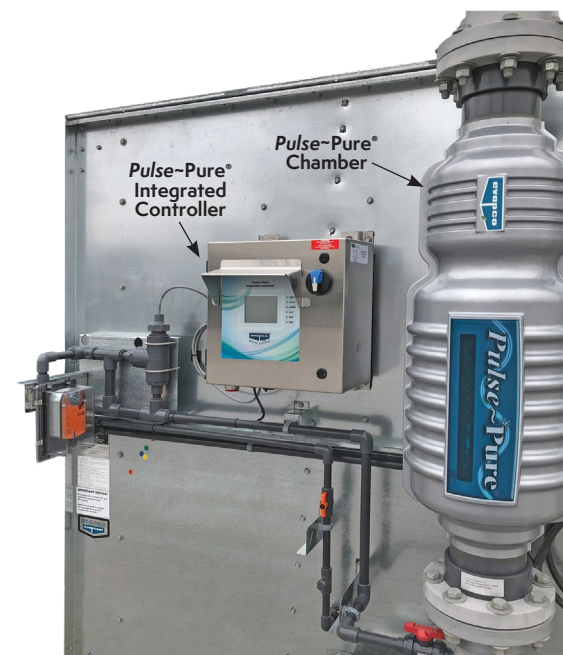

EVAPCO's *Pulse~Pure*® water treatment system utilizes pulsed electric field technology to provide an environmentally responsible alternative for the treatment of water in evaporative cooling equipment. The *Pulse~Pure*® system delivers short low- and high-frequency bursts of electromagnetic fields to the recirculating water in the fluid cooler.

- EVAPCO guarantees that total bacterial counts will not exceed 10,000 CFU/ml in the cooling water
- Controls scale, corrosion, and microbiological growth with absolutely no chemicals required
- Compact design with no moving parts and low energy consumption



Learn more about *Pulse~Pure*® at evapco.com.



Smart Shield® Solid Chemical Water Treatment System



EVAPCO's *Smart Shield*® system utilizes proven solid chemistry delivered via our revolutionary feed system. With patented Controlled Release tablets, a scale and corrosion inhibitor is fed whenever your spray water pump is energized, keeping your system protected anytime the spray water pump is operating. *Smart Shield*® is a complete water treatment package that:

- Utilizes 'Bag in Bag' no touch chemical replenishments, making reloads easier and safer
- Creates reduced packaging, shipping and handling providing a reduced carbon footprint compared to liquid chemicals
- Eliminates the hazards associated with liquid chemicals, potential for liquid spills and the need for expensive feed pumps making it the easiest and safest chemical water treatment system available today



Watch a short product video at evapco.com.

All LSWE and LRWB Series units are constructed with galvanized steel panels as standard. The following pages illustrate the available stainless steel construction material options for this series. Stainless steel options are available in both 304 and 316L stainless steel. Selection of these options only changes the sheet steel; optional accessories such as attenuation, discharge hoods, platforms, etc. are available in stainless steel only by special order. Stainless steel discharge hoods/attenuation have galvanized dampers with a stainless steel linkage. Accessories, coils, and fan shafts **do not** change to stainless steel with these options and are upgraded separately. The strainer in the basin is always 304 stainless steel independent of basin construction.

LSWE

Stainless Steel Basin up to Overflow Level Option

Includes Type 304 stainless steel basin panels up to the overflow level. All panels above the overflow, including the fan discharge cowls are G-235 galvanized steel. Centrifugal fan wheels are **not available** in stainless steel.

This is the first stage of stainless steel on the LS Series units 5' wide and larger. The "stainless steel basin up to overflow" option is not available on 4' wide models.

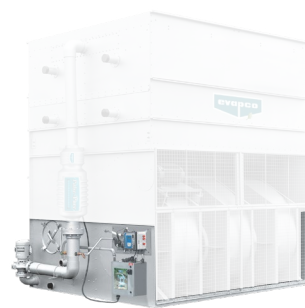

Stainless Steel Water Touch Basin

All panels in the pan section in contact with the cooling water including the fan discharge cowls are constructed of Type 304 stainless steel. Remainder of unit constructed of G-235 galvanized steel. All models with this option are furnished with epoxy coated fan wheels and shafts coated with a rust inhibitor. Centrifugal fan wheels are **not available** in stainless steel.

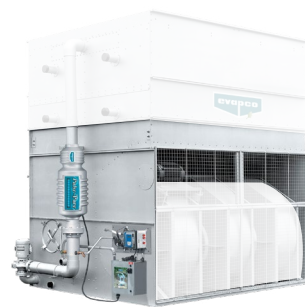

Stainless Steel Water Touch Unit

All panels in contact with the cooling water including the upper casing panels are constructed of Type 304 stainless steel. All models with this option are furnished with epoxy coated fan wheels and shafts coated with a rust inhibitor. Centrifugal fan wheels are **not available** in stainless steel.

This option designates the entire water section as stainless. Note that the fan housings and supports are still galvanized in this option.

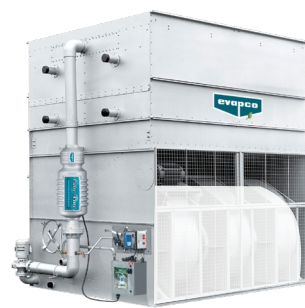

All Stainless Steel Except Fans Option

All panels including the fan housings and supports are constructed of Type 304 stainless steel. All models with this option are furnished with epoxy coated fan wheels and shafts coated with a rust inhibitor. Centrifugal fan wheels are **not available** in stainless steel. With this option, all sheet metal is stainless including the fan housings and supports.



LRWB

Stainless Steel Cold Water Basin

With this option, the lowest section of the unit, as highlighted in the photograph to the right, is constructed of Type 304 stainless steel. On all LRWB units, the fan side inlet screens are PVC coated. Fan screens are galvanized.

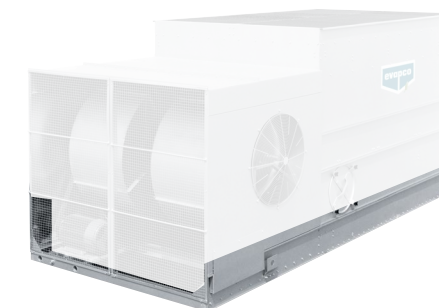

Stainless Steel Water Touch Basin

All panels in the pan section in contact with the cooling water including the fan discharge cowls are constructed of Type 304 stainless steel. The remainder of unit is constructed of G-235 galvanized steel.

All models with this option are furnished with epoxy coated fan wheels and shafts coated with a rust inhibitor. Centrifugal fan wheels are **not available** in stainless steel. Fan screens are galvanized.

NOTE: LRWB models have carbon steel coils, which are hot dip galvanized after fabrication as standard.

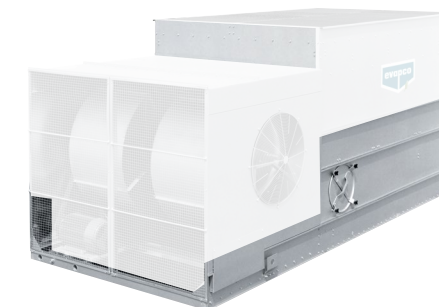

Stainless Steel Water Touch Unit

All panels in contact with the cooling water including the upper casing panels are constructed of Type 304 stainless steel. All models with this option are furnished with epoxy coated fan wheels and shafts coated with a rust inhibitor. Centrifugal fan wheels are **not available** in stainless steel. Fan screens are galvanized. This option designates the entire water section as stainless.

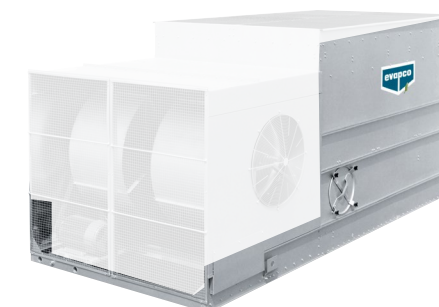

All Stainless Steel Option (Excluding Fans/Coils)

All panels including the fan housings and supports are constructed of Type 304 stainless steel. All models with this option are furnished with epoxy coated fan wheels and shafts coated with a rust inhibitor. Centrifugal fan wheels are **not available** in stainless steel. With this option, all sheet metal is stainless including the Fan Housings and Supports. Fan screens are stainless steel.

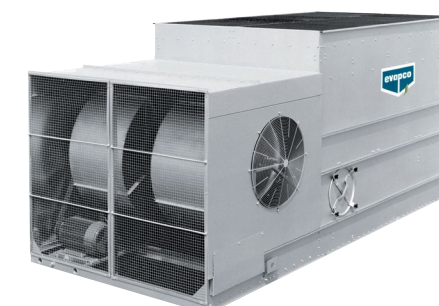

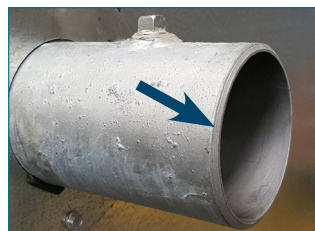

Beveled For Weld (BFW) Coil Connections

EVAPCO closed circuit coolers are provided with beveled for weld (BFW) coil connections as standard. Beveled edges simplify field welding and allow welds to fully penetrate.



Optional Factory Mounted Crossover Piping

Some EVAPCO closed circuit coolers are design for "series flow" coil operation where the coils inside of one cell are operated in series. These units are denoted by a "-Z" following the unit model number. These units require "crossover piping" from one coil to the other. As an option, this piping can be installed in the factory for simplified field installation.



Optional Grooved Coil Connections

Grooved connections can be provided as an optional coil connection. The groove allows for a mechanical coupling allowing for faster and easier field piping.

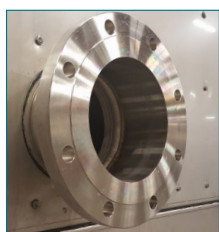

Optional Flanged Coil Connections

150# raised faced flanged connections can be provided as an optional coil connection. The flanged coil connection allows for faster and easier field piping to a mating flanged connection. 300# flanged can be provided in some cases. Please contact your local EVAPCO sales representative for more information.



Optional Nitrogen Charged Coils

For projects requiring long term storage or ocean freight, coils can be nitrogen charged at the factory to prevent corrosion inside of the coil circuits.

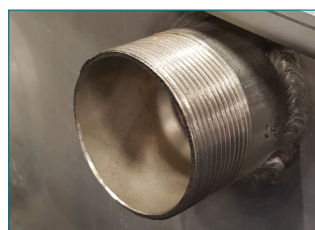

Optional Male Pipe Thread (MPT) Coil Connections

Male pipe thread (MPT) connections can be provided as an optional connection for mating with female pipe thread (FPT) piping.

NOTE: All coil connections are constructed from the same material as the coil.

Sound Attenuation Packages

The centrifugal fan design of the LSWE and LRWB models operate at lower sound levels which make these units preferable for installations where noise is a concern. For sound-sensitive applications, the LSWE and LRWB centrifugal fan models may be supplied with various stages of intake and/or discharge attenuation packages which further reduce sound levels.

Consult the factory for certified sound data for each sound attenuation option.

NOTE: Sound attenuation packages may require oversized fan motors.

Fan Side Inlet Attenuation (LRWB Only)

Reduces sound radiated from the fan side air intakes and has an open side to allow for air entry. **This attenuation package ships loose to be mounted in the field on each side of the closed circuit cooler over the fan intakes.**

Fan End Inlet Attenuation

Reduces sound radiated through the end air intakes. It consists of baffled panels that change the path of the air entry and capture the radiated noise thus reducing the overall sound levels generated. In addition, the external belt adjustment mechanism is extended through the inlet attenuator to allow for easy adjustment without having to enter the unit. Solid bottom panels are included with this option to force the inlet air through the attenuator.

Discharge Attenuation

The discharge attenuation hood features a straight-sided design with insulated baffles to reduce the overall sound levels of the discharge air. The discharge attenuation incorporates a large access panel to allow entry to the drift eliminators and water distribution system. **If a higher discharge velocity is required with minimal sound attenuation, a tapered discharge hood is available.**

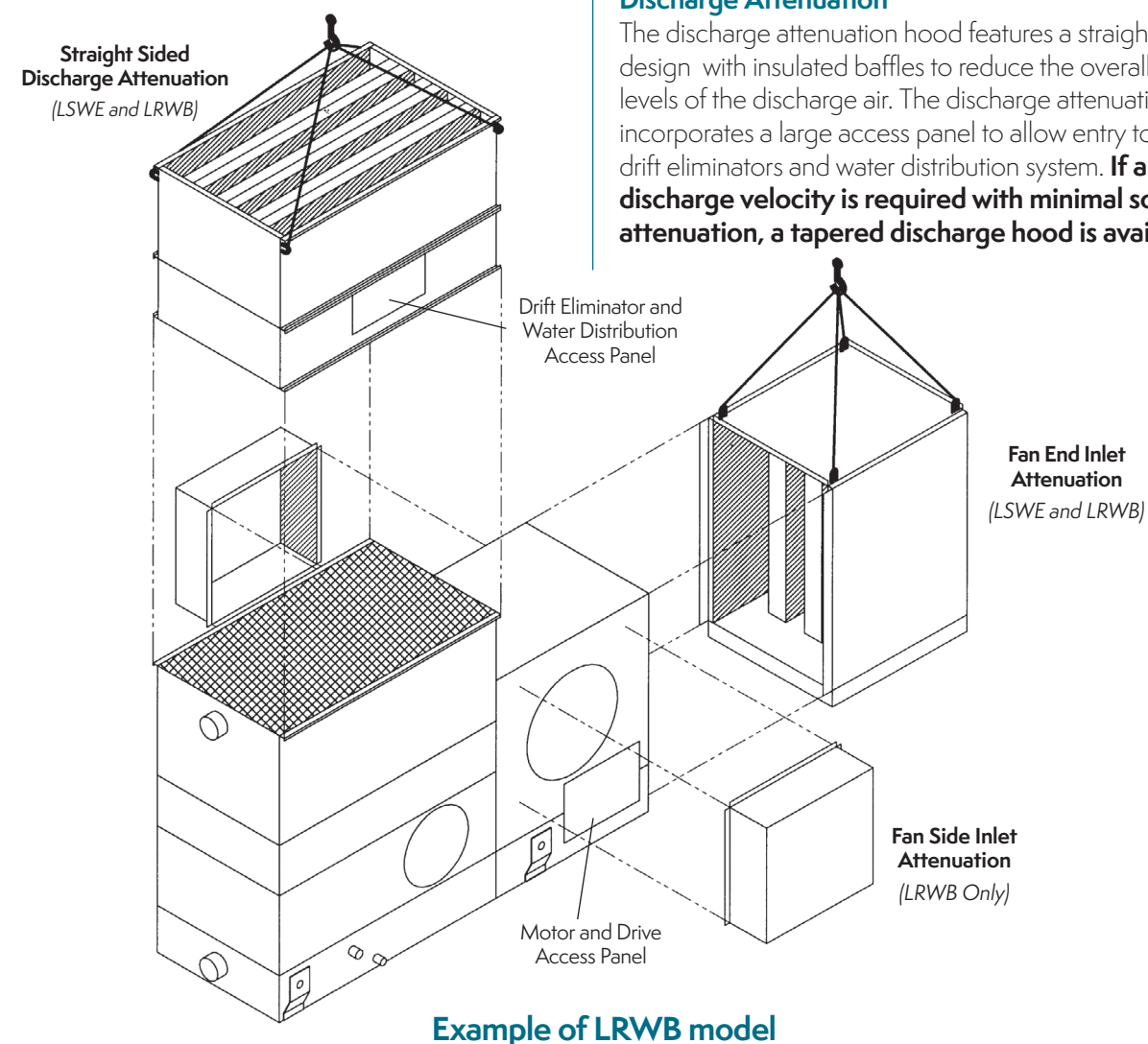

Example of LRWB model

LSWE Discharge & Intake Attenuation

LSWE Discharge Attenuation Dimensions*

Unit Footprint	H1 (in.)	L1 (in.)	W1 (in.)	Weight (lb.)	No. of Atten.
4' x 6'	47	71-7/8	45-1/2	565	1
4' x 9'	47	107-1/4	45-1/2	745	1
4' x 12'	47	143-1/2	45-1/2	1000	1
4' x 18'	47	216	45-1/2	1370	1
5' x 12'	47	143-1/2	61-7/8	1215	1
5' x 18'	47	216	61-7/8	1660	1
8P' x 12'	71-3/8	143-3/4	92-1/4	2290	1
8P' x 18'	71-3/8	216	92-1/4	3120	1
8P' x 24'	71-3/8	143-3/4	92-1/4	2290	2
8P' x 36'	71-3/8	216	92-1/4	3120	2
10' x 12'	71-3/8	143-1/2	119	2715	1
10' x 18'	71-3/8	216	119	3680	1
10' x 24'	71-3/8	143-1/2	119	2715	2
10' x 36'	71-3/8	216	119	3680	2

LSWE Intake Attenuation Dimensions*

Unit Footprint	H2 (in.)	L2 (in.)	Compact Weight (lb.)	Basic Weight (lb.)	Extended Weight (lb.)	No. of Atten.
4' x 6'	39-3/4	74-5/8	610	760	980	1
4' x 9'	39-3/4	111	870	1070	1350	1
4' x 12'	39-3/4	147-1/4	1120	1360	1710	1
4' x 18'	39-3/4	219-3/4	1750	2060	2520	1
5' x 12'	46-1/4	147-1/4	1380	1570	1850	1
5' x 18'	46-1/4	219-3/4	2130	2370	2720	1
8P' x 12'	81-1/2	147-3/8	1820	2130	2590	1
8P' x 18'	81-1/2	219-3/4	2770	3180	3780	1
8P' x 24'	81-1/2	145-3/8	1820	2115	2555	2
8P' x 36'	81-1/2	217-7/8	2805	3175	3740	2
10' x 12'	89	147-1/2	2020	2330	2780	1
10' x 18'	89	220	2750	3270	4050	1
10' x 24'	89	145-1/2	2030	2320	2745	2
10' x 36'	89	218-1/8	3140	3490	4015	2

* Attenuation dimensions may vary slightly from catalog. See factory certified prints for exact dimensions.

NOTE: Weights provided in the tables above are per attenuator.

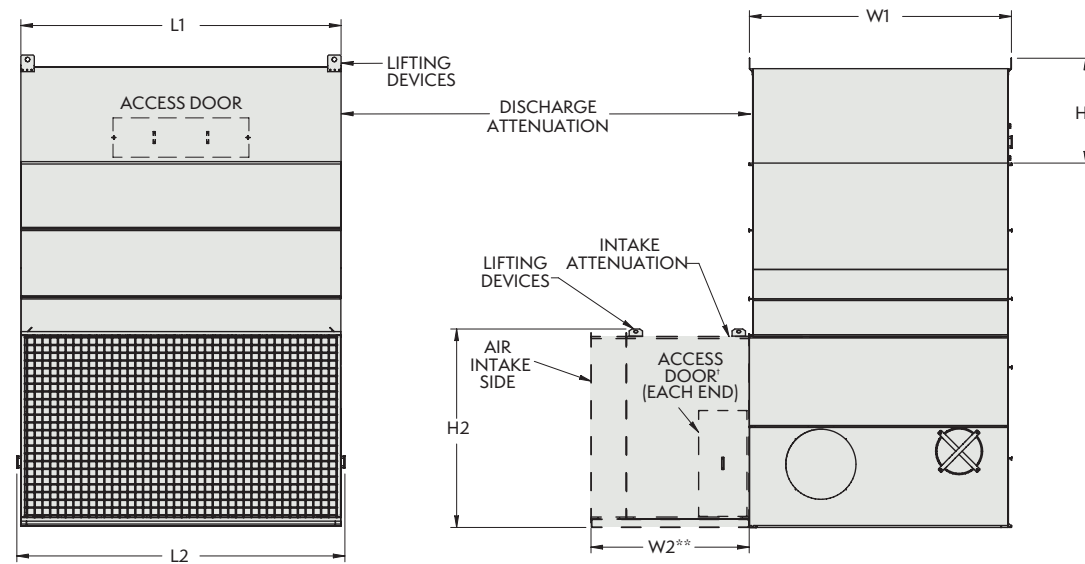

LSWE Attenuation

** Measurements for W2 will vary based on selected attenuation (Compact, Basic, or Extended).

† Please note the Compact option has NO access door.

W2 Variations (in.)	
Compact	45
Basic	55-1/2
Extended	71-3/8

NOTE: Intake sound attenuation must be fully supported. If the recommended steel support is being used a third I-beam is required for the intake attenuation. Refer to page 22.

NOTE: Sound attenuation packages may require oversized fan motors.

LRWB Discharge & Intake Attenuation

LRWB Discharge Attenuation Dimensions*

Coil Casing Footprint	H1 (in.)	L1 (in.)	W1 (in.)	Weight per (in.)	Number of Attenuator
3' x 6'	43-3/8"	71-3/4"	40-1/2"	670	1
5' x 6'	43-3/8"	71-1/4"	60-5/8"	850	1
5' x 9'	43-3/8"	107-1/4"	60-5/8"	1,170	1
5' x 12'	43-3/8"	143-5/8"	60-5/8"	1,990	1
8' x 9'	43-3/8"	107-1/4"	94"	1,570	1
8' x 12'	43-3/8"	143-5/8"	94"	2,030	1

LRWB Fan End Attenuation Dimensions*

Coil Casing Footprint	H2 (in.)	W2 (in.)	L2 (in.)	Weight per (in.)	Number of Attenuator
3' x 6'	63-7/8"	40-1/2"	43-5/8"	810	1
5' x 6'	79-5/8"	60-5/8"	43-1/2"	1280	1
5' x 9'	79-5/8"	60-5/8"	43-1/2"	1280	1
5' x 12'	79-5/8"	60-5/8"	43-1/2"	1280	1
8' x 9'	79-5/8"	94-1/4"	43-5/8"	1530	1
8' x 12'	79-5/8"	94-1/4"	43-5/8"	1530	1

LRWB Fan Side Attenuation Dimensions*

Coil Casing Footprint	H3 (in.)	W3 (in.)	L3 (in.)	Weight per (in.)	Number of Attenuator
3' x 6'	33-5/8"	64-3/4"	34-3/4"	60	2
5' x 6'	36-7/8"	84-7/8"	54"	60	2
5' x 9'	36-7/8"	84-7/8"	54"	60	2
5' x 12'	36-7/8"	84-7/8"	54"	60	2
8' x 9'	42-3/8"	118-1/2"	44-1/8"	60	2
8' x 12'	42-3/8"	118-1/2"	44-1/8"	60	2

* Attenuation dimensions may vary slightly from catalog. See factory certified prints for exact dimensions.

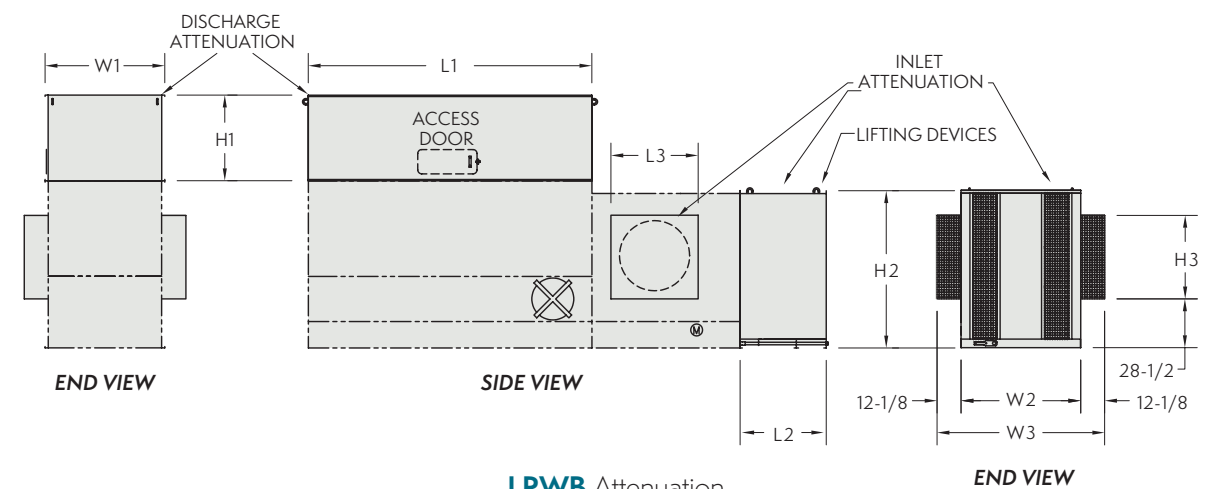

LRWB Attenuation

NOTE: Intake sound attenuation must be fully supported. If the recommended steel support is being used, extended "I" beams are required for the intake attenuation. Refer to page 22.

NOTE: Sound attenuation packages may require oversized fan motors.

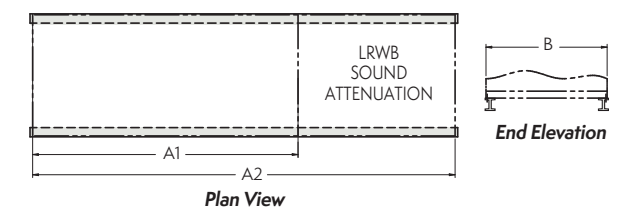

Freeze Protection

If the units are installed in a cold climate and operated year-round, freeze protection must be provided for the heat exchanger coil in the unit as well as for the recirculating water system.

Recirculating Water System Freeze Protection Options

Remote Sump Configuration

The surest way to protect the recirculating water system from freezing is with a remote sump. The remote sump should be located inside the building and below the unit. **When a remote sump arrangement is selected, the spray pump is provided by others and installed at the remote sump.** All water in the closed circuit cooler basin should drain to the remote sump when the spray pump cycles off.

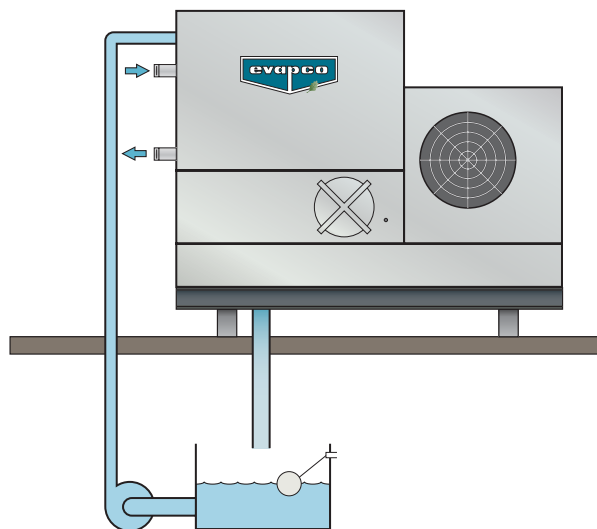

Steam/Hot Water Coils

Steam or hot water coils are available as an alternative to using electric basin heaters or a remote sump. Constructed of galvanized pipe, the coils are installed in the closed circuit cooler basin, and are ready for piping to an external hot water source. **Controls for steam/hot water coils are provided by others and should be interlocked with the water circulating pump to prevent their operation when the pump is energized.**

Basin Heater Package

If a remote sump configuration is not practical, electric basin heater packages are available to keep the pan water from freezing when the unit cycles off. Water lines to and from the unit, spray pump and related piping should be heat traced and insulated up to the overflow level to protect from freezing. **Basin heaters should be interlocked with the water circulating pump to prevent their operation when the pump is energized.**

This unit should not be operated dry (fans on, pump off) unless the basin is completely drained or the heaters have been oversized and the unit has been designed for dry operation. Consult the factory when dry operation is a requirement.

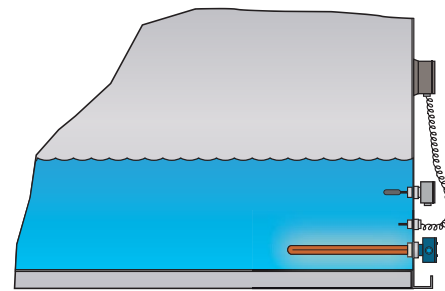

LSWE Basin Heater Sizing

Unit Footprint	kW (0°F)	kW (-20°F)	kW (-40°F)
4' x 6'	(1) 2	(1) 3	(1) 4
4' x 9'	(1) 3	(1) 4	(1) 5
4' x 12'	(1) 3	(1) 5	(1) 7
4' x 18'	(1) 5	(1) 7	(1) 9
5' x 12'	(1) 4	(1) 6	(1) 8
5' x 18'	(2) 3	(2) 4	(1) 12
8P' x 12'	(1) 5	(1) 8	(1) 10
8P' x 18'	(2) 4	(2) 6	(2) 7
8P' x 24'	(2) 5	(2) 7	(2) 10
8P' x 36'	(2) 7	(2) 12	(2) 15
10' x 12'	(1) 7	(1) 10	(1) 15
10' x 18'	(2) 5	(2) 7	(2) 10
10' x 24'	(2) 7	(2) 10	(2) 15
10' x 36'	(2) 10	(4) 7	(4) 9

LRWB Basin Heater Sizing

Unit Footprint	kW (0°F)	kW (-20°F)	kW (-40°F)
3' x 6'	(1) 2	(1) 3	(1) 4
5' x 6'	(1) 3	(1) 5	(1) 6
5' x 9'	(1) 4	(1) 6	(1) 8
5' x 12'	(1) 6	(1) 8	(1) 12
8' x 9'	(1) 7	(1) 9	(1) 12
8' x 12'	(1) 9	(1) 12	(1) 16

Heat Exchanger Coil Freeze Protection Options

The simplest and most foolproof method of protecting the heat exchanger coil from freeze-up is to use a glycol solution. If this is not possible, an auxiliary heat load must be maintained on the coil at all times so that the water temperature does not drop below 50°F when the cooler is shut down and, a minimum recommended flow rate per unit as shown in the table below must be maintained. Refer to Heat Loss Data Table on page 21 for heat loss data.

LSWE Minimum Flows for Freeze Protection

Unit Footprint	Minimum Flow for Freeze	
	Standard Unit	Series Flow Unit (-Z)
4' x 6'	66	33
4' x 9'	66	33
4' x 12'	66	33
4' x 18'	66	33
5' x 12'	94	47
5' x 18'	94	47
8P' x 12'	148	74
8P' x 18'	148	74
8P' x 24'	296	148
8P' x 36'	296	148
10' x 12'	188	94
10' x 18'	188	94
10' x 24'	376	188
10' x 36'	376	188

LRWB Minimum Flows for Freeze Protection

Coil Casing Footprint	Minimum Flow for Freeze	
	Standard Unit	Series Flow Unit (-Z)
3' x 6'	60	30
5' x 6'	94	47
5' x 9'	94	47
5' x 12'	94	47
8' x 9'	148	74
8' x 12'	148	74

If an anti-freeze solution is not used, the coil must be drained immediately whenever the pump is shut down or flow stops. Care must be taken to ensure that the piping is sized to allow the water to flow quickly from the coil. This method of freeze control should only be used in an emergency situation. Coils should not be drained for an extended period of time. Leaving the coil drained and open to the atmosphere can cause corrosion inside the tubes which may lead to premature coil failure.

The amount of glycol required for a system will depend upon the total volume of water in the closed loop and the winter ambient conditions for the installation. The engineering data tables presented on pages 25-41 provide the water volume contained inside the cooler coils to assist in this calculation.

Discharge Hoods with Positive Closure Dampers

When a closed circuit cooler is used in a water-to-air heat pump system or in certain process cooling applications, a method of reducing the heat loss during idle periods of wintertime operation may be required. **For these cases, an optional discharge hood with positive closure dampers and damper actuator is available.**

The discharge hood with dampers is designed to minimize the heat loss from convective airflow through an idle cooler. Further reductions in heat loss may be obtained with the addition of insulation to the hood and casing, minimizing conductive heat losses. **Optional insulation may be factory-installed on the hood and casing or field-installed by an insulation contractor.**

The discharge hood and dampers are constructed of hot-dip galvanized steel as standard. Hoods are equipped with access panels to facilitate maintenance on the eliminators and water distribution system. The dampers, damper actuator and linkage are all factory-assembled. **Actuator controls and wiring are field-supplied by others. Damper actuators require 120 volt power supply. Stainless steel discharge hoods with galvanized positive closure dampers are available as an optional accessory.**

The system control sequence should provide for dampers to be fully open before the fans are running and closed when the fans are off; the damper actuator must be interlocked with the temperature control system for this purpose.

When a tapered discharge hood is specified, the next larger size fan motor must be used to overcome the additional static pressure.

Heat loss data is provided for standard units without hoods, with hoods and with hoods and insulation. Table ratings are based on 50°F water in the coil, -10°F ambient and 45 MPH winds (fan and pump off).

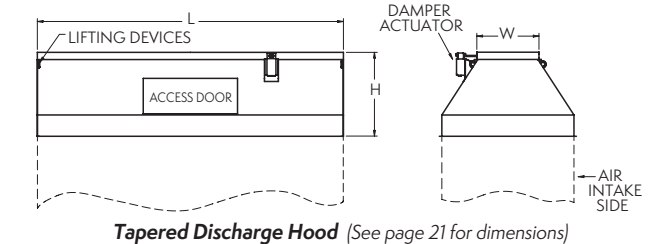

Tapered Discharge Hood (See page 21 for dimensions)

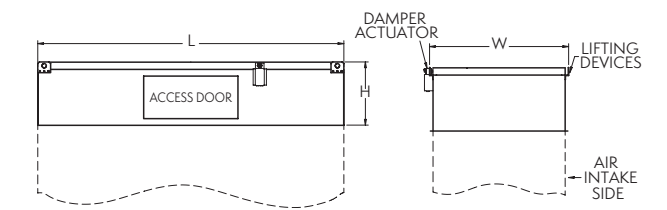

Straight-Sided Discharge Hood (See page 21 for dimensions)

LSWE Heat Loss Data

LSWE Model	Standard Unit (MBH)	Unit with Hood (MBH)	With Hood & Insulation
4-2x6	37	29	19
4-3x6	50	33	21
4-4x6	61	36	23
4-5x6	68	39	25
4-3x9	76	44	28
4-4x9	92	48	31
4-5x9	104	52	33
4-3x12	103	54	35
4-4x12	124	60	38
4-5x12	140	65	42
4-3x18	155	76	49
4-4x18	188	84	54
4-5x18	211	91	58
5-3x12	147	70	45
5-4x12	178	77	49
5-5x12	200	83	53
5-6x12	213	90	57
5-7x12	231	98	62
5-3x18	223	96	62
5-4x18	269	105	67
5-5x18	303	114	73
5-6x18	322	123	79
5-7x18	349	134	86
8-3x12	227	98	63
8-4x12	276	105	67
8-5x12	309	112	72
8-6x12	329	119	76
8-3x18	311	132	85
8-4x18	376	141	90
8-5x18	468	150	96
8-6x18	499	159	102
8-7x18	541	173	111

LSWE Model	Standard Unit (MBH)	Unit with Hood (MBH)	With Hood & Insulation
8-3x24	454	196	126
8-4x24	552	210	134
8-5x24	618	224	144
8-6x24	658	238	152
8-7x24	713	258	165
8-3x36	688	264	170
8-4x36	834	282	180
8-5x36	936	300	192
8-6x36	998	318	204
8-7x36	1082	345	221
10-3x12	294	109	69
10-4x12	356	117	75
10-5x12	400	125	80
10-6x12	426	134	86
10-7x12	462	146	94
10-3x18	445	143	91
10-4x18	539	153	98
10-5x18	605	164	105
10-6x18	644	175	112
10-7x18	698	190	122
10-3x24	588	217	139
10-4x24	712	234	150
10-5x24	799	251	160
10-6x24	851	267	171
10-7x24	922	290	186
10-3x36	870	285	182
10-4x36	1078	307	196
10-5x36	1210	328	210
10-6x36	1289	349	223
10-7x36	1397	379	242

LRWB Heat Loss Data

LRWB Model	Standard Unit (MBH)	Unit with Hood (MBH)	With Hood & Insulation
3-2x6	33	29	22
3-3x6	46	36	23
3-4x6	54	39	25
3-5x6	62	42	27
5-2x6	52	44	29
5-3x6	72	45	30
5-4x6	87	49	31
5-5x6	98	53	34
5-3x9	110	59	38
5-4x9	133	64	41
5-5x9	149	69	44
5-6x9	159	73	47
5-7x9	162	86	55
5-3x12	147	74	47
5-4x12	178	80	51
5-5x12	200	85	55
5-6x12	213	91	59
5-7x12	217	107	68
8-3x9	170	77	49
8-4x9	205	83	53
8-5x9	231	89	57
8-6x9	246	94	61
8-7x9	250	110	71
8-3x12	228	94	60
8-4x12	276	101	64
8-5x12	310	107	69
8-6x12	330	114	73
8-7x12	336	133	85

Discharge Hood Dimensions

LSWE Tapered Discharge Hood Dimensions

Unit Footprint	H (in.)	L (in.)	W (in.)	Weight per Hood (lbs.)	# of Hoods
4' x 6'	33	71-7/8	21-1/8	205	1
4' x 9'	33	107-1/4	21-1/8	275	1
4' x 12'	33	143-1/2	21-1/8	350	1
4' x 18'	33	216	21-1/8	485	1
5' x 12'	39-1/2	143-1/2	29-1/8	450	1
5' x 18'	39-1/2	216	29-1/8	615	1
8P' x 12'	42-5/8	143-3/4	45-5/8	615	1
8P' x 18'	42-5/8	216	45-5/8	835	1
8P' x 24'	42-5/8	143-3/4	45-5/8	1,230	2
8P' x 36'	42-5/8	216	45-5/8	1,670	2
10' x 12'	50-3/8	143-5/8	58-1/8	775	1
10' x 18'	50-3/8	216	58-1/8	1,055	1
10' x 24'	50-3/8	143-5/8	58-1/8	1,550	2
10' x 36'	50-3/8	216	58-1/8	2,110	2

LSWE Straight-Sided Discharge Hood Dimensions

Unit Footprint	H (in.)	L (in.)	W (in.)	Weight per Hood (lbs.)	# of Hoods
4' x 6'	30	71-7/8	45-1/2	180	1
4' x 9'	30	107-1/4	45-1/2	250	1
4' x 12'	30	143-1/2	45-1/2	300	1
4' x 18'	30	216	45-1/2	395	1
5' x 12'	30	143-1/2	62	330	1
5' x 18'	30	216	62	495	1
8P' x 12'	30	143-3/4	95-1/2	450	1
8P' x 18'	30	216	95-1/2	615	1
8P' x 24'	30	143-3/4	95-1/2	900	2
8P' x 36'	30	216	95-1/2	1,230	2
10' x 12'	30	143-5/8	119-1/8	625	1
10' x 18'	30	216-1/4	119-1/8	855	1
10' x 24'	30	143-5/8	119-1/8	1,250	2
10' x 36'	30	216-1/4	119-1/8	1,710	2

LRWB Tapered Discharge Hood Dimensions

Coil Casing Footprint	H (in.)	L (in.)	W (in.)	Weight per Hood (lbs.)	# of Hoods
3' x 6'	24-1/2	71-7/8	19	235	1
5' x 6'	39-1/4	71-7/8	29	390	1
5' x 9'	39-1/4	107-1/4	29	520	1
5' x 12'	39-1/4	143-5/8	29	680	1
8' x 9'	42-1/2	107-1/4	42-1/2	785	1
8' x 12'	42-1/2	143-5/8	42-1/2	975	1

LRWB Straight-Sided Discharge Hood Dimensions

Coil Casing Footprint	H (in.)	L (in.)	W (in.)	Weight per Hood (lbs.)	# of Hoods
3' x 6'	29-1/2	71-7/8	40-1/2	370	1
5' x 6'	29-1/2	71-7/8	60-5/8	470	1
5' x 9'	29-1/2	107-1/4	60-5/8	680	1
5' x 12'	29-1/2	143-5/8	60-5/8	860	1
8' x 9'	29-1/2	107-1/4	94	985	1
8' x 12'	29-1/2	143-5/8	94	1,245	1

Steel Support

The recommended support for EVAPCO Closed Circuit Coolers is structural I-beams located under the outer flanges and running the entire length of the unit. Mounting holes 3/4" in diameter are located in the bottom channels of the pan section to provide for bolting to the structural steel. (Refer to certified drawings from the factory for bolt hole locations.)

Beams should be level to within 1/360 of unit length, not to exceed 1/2" before setting the unit in place. Do not level the unit by shimming between it and the I-beams as this will not provide proper longitudinal support.

LRWB Dimensions

Coil Casing Footprint	A1 (Unit Only)	A2 (Unit with Intake Atten.)	B
3' x 6'	10' 1-7/8"	13' 9-5/8"	3' 4-1/2"
5' x 6'	12' 2-7/8"	15' 10-5/8"	5' 5/8"
5' x 9'	15' 2-1/4"	18' 10"	5' 5/8"
5' x 12'	18' 2-5/8"	21' 10-3/8"	5' 5/8"
8' x 9'	15' 2-1/4"	18' 10"	7' 10"
8' x 12'	18' 2-5/8"	21' 10-3/8"	7' 10"

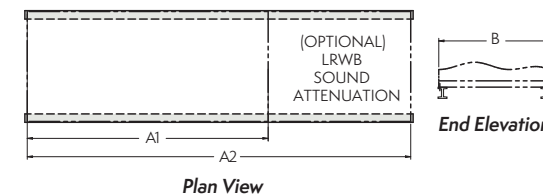

LSWE Dimensions

Coil Casing Footprint	B1 (Unit Only)	B2 (Compact Option)	B3 (Basic Option)	B4 (Extended Option)	A
4' x 6'	4' 5/8"	7' 9-5/8"	8' 8-1/4"	10'	5' 11-7/8"
4' x 9'	4' 5/8"	7' 9-5/8"	8' 8-1/4"	10'	8' 11-1/4"
4' x 12'	4' 5/8"	7' 9-5/8"	8' 8-1/4"	10'	11' 11-1/2"
4' x 18'	4' 5/8"	7' 9-5/8"	8' 8-1/4"	10'	18'
5' x 12'	5' 5"	9' 2"	10' 5/8"	11' 3-15/16"	11' 11-1/2"
5' x 18'	5' 5"	9' 2"	10' 5/8"	11' 3-15/16"	17' 11-7/8"
8P' x 12'	7' 10"	11' 7"	12' 5-5/8"	13' 8-7/8"	11' 11-3/4"
8P' x 18'	7' 10"	11' 7"	12' 5-5/8"	13' 8-7/8"	18'
8P' x 24'	7' 10"	11' 7"	12' 5-5/8"	13' 8-7/8"	24' 1"
8P' x 36'	7' 10"	11' 7"	12' 5-5/8"	13' 8-7/8"	36' 1-1/2"
10' x 12'	9' 9-3/4"	13' 6-3/4"	14' 5-3/8"	15' 8-5/8"	11' 11-3/4"
10' x 18'	9' 9-3/4"	13' 6-3/4"	14' 5-3/8"	15' 8-5/8"	18' 1/4"
10' x 24'	9' 9-3/4"	13' 6-3/4"	14' 5-3/8"	15' 8-5/8"	24' 1-1/8"
10' x 36'	9' 9-3/4"	13' 6-3/4"	14' 5-3/8"	15' 8-5/8"	36' 2-1/8"

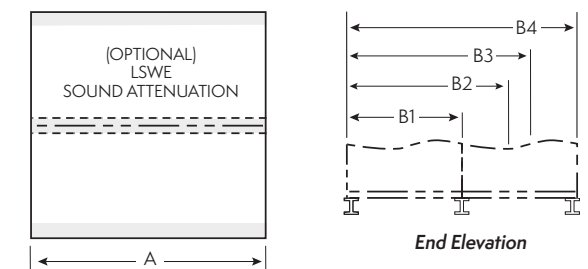

Optional Equipment

Electric Water Level Control

Closed Circuit Coolers may be ordered with an electric water level control in lieu of the standard mechanical float and make-up assembly. This package provides accurate control of water levels and does not require field adjustment.

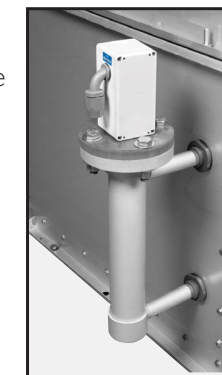

Bottom Screens

Protective inlet screens are provided on the sides and/or end of the unit's air intake. Screens are not provided below the fan section since most units are mounted on the roof or at ground level. It is recommended that bottom screens be added to the unit when it will be elevated. These screens can be provided by the factory at an additional cost or added by the installing contractor.

Solid Bottom Panels for Ducted Installations

When centrifugal fan units are installed indoors and intake air is ducted to the unit, a solid bottom panel is required to completely enclose the fan section and prevent the unit from drawing air from the room into the fan intakes. When this option is ordered, air inlet screens are omitted and the next larger size fan motor must be used to overcome the additional static pressure.

LRWB Reduced Height and Maintenance Accessibility

The LRWB has been designed to satisfy installation requirements where height limits must be observed. The lower profile design of the LRWB does not, however, sacrifice maintenance accessibility for reduced height. Its unique casing design allows the water distribution system, cold water basin, fan section and other unit components to be easily maintained.

Small, light-weight sections of the drift eliminators can be easily removed to access the water distribution system. A large circular access door is located on the side of the cold water basin to allow adjustment of the float assembly, removal of the stainless steel strainers and cleaning of the basin. The fan motor and drive system are located at one end of the unit and are completely accessible by removing the inlet screens. Routine bearing lubrication and belt tensioning can be performed from the exterior of the unit without removing the inlet screens.

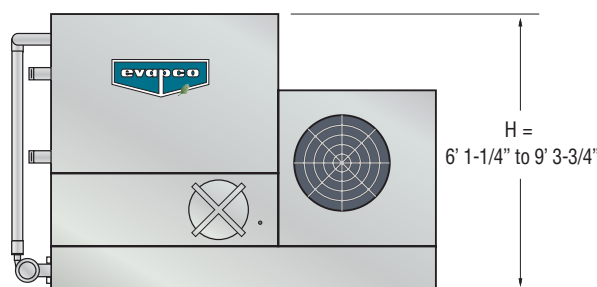

Low Installed Costs

The compact, unitary design of the LRWB closed circuit cooler allows it to be shipped completely assembled. This results in lower transportation costs and no assembly requirements at the job site.

NOTE: Options such as sound attenuation and discharge hoods will require additional lifts and some minor assembly.

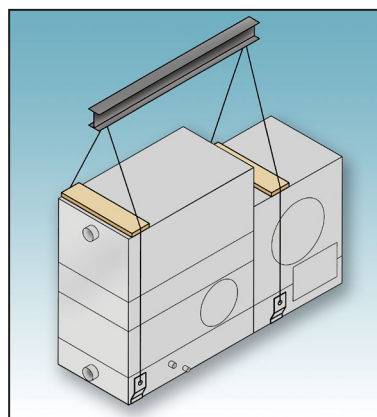

Transport of a Pre-Assembled Unit

Since the LRWB ships fully assembled, it is ideal for truck-mounted applications, for remote sites or temporary installations.

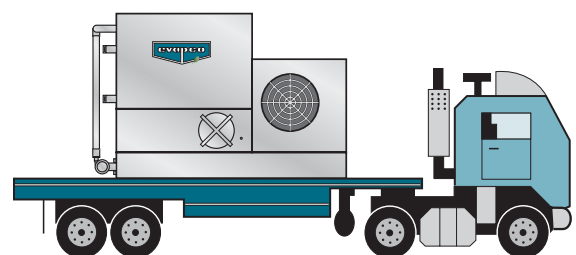

Stainless Steel Cold Water Basin

Stainless steel cold water basins are optional on the LRWB. Additional upgrades to stainless steel water touch basins, stainless steel water touch units and all stainless steel construction are also available on this unit. For more information on stainless steel construction options, refer back to pages 13 and 14 of this catalog.



Integral Fan Enclosure for Lower Sound

The LRWB comes standard with an integral fan enclosure that reduces sound levels by 2 dB. This 3-sided enclosure also protects the fan and drive system for longer equipment life.

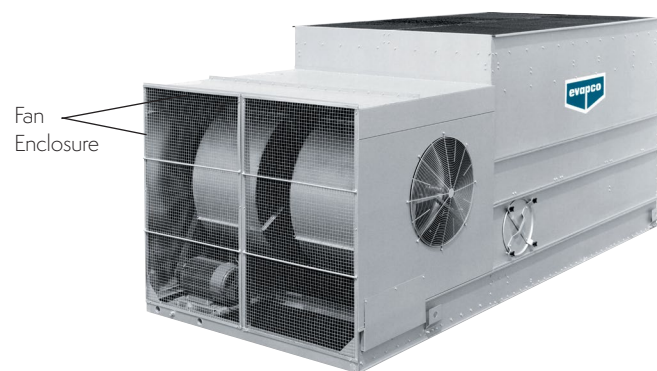

Design

EVAPCO closed circuit coolers are of heavy-duty construction and designed for long trouble-free operation. Proper equipment selection, installation and maintenance is, however, necessary to ensure full unit performance. Some of the major considerations in the application of a cooler are presented below. For additional information, contact the factory.

Air Circulation

It is important that proper air circulation be provided. The best location is on an unobstructed roof top or on ground level away from walls and other barriers. Those closed circuit coolers located in wells, enclosures or adjacent to high walls must be properly located to avoid the problems associated with recirculation.

Recirculation raises the wet bulb temperature of the entering air causing the water temperature to rise above the design. For these cases, the discharge of the unit should be located at a height even with the adjacent wall, thereby reducing the chance of recirculation. For additional information, see the EVAPCO equipment layout manual. Good engineering practice dictates that the closed circuit cooler discharge air not be directed or located close to or in the vicinity of building air intakes.

Piping

Cooler piping should be designed and installed in accordance with generally accepted engineering practices. The piping layout should be symmetrical on multiple unit systems, and sized for a reasonably low water velocity and pressure drop. The standard closed circuit cooler is recommended only on a closed, pressurized system. The piping system should include an expansion tank to allow for fluid expansion and purging air from the system.

NOTE: Closed circuit coolers should never be used on an open type system. An open type system with a cooler may result in premature coil failure.

The piping system should be designed to permit complete drainage of the heat exchanger coil. This will require a vacuum breaker or air vent to be installed at the high point and a drain valve installed at the low point of the piping system. Both must be adequately sized.

All piping should be securely anchored by properly designed hangers and supports. No external loads should be placed upon the cooler connections, nor should any of the pipe supports be anchored to the cooler framework.

Recirculating Water Quality

Proper water treatment is an essential part of the maintenance required for evaporative cooling equipment. A well designed and consistently implemented water treatment program will help to ensure efficient system operation while maximizing the equipment's service life. **If EVAPCO factory mounted water systems are not utilized**, a qualified water treatment company should design a site specific water treatment protocol based on equipment (including all metallurgies in the cooling system), location, makeup water quality, and usage.

Bleed off

Evaporative cooling equipment requires a bleed or blowdown line, located on the discharge side of the recirculating pump, to remove concentrated (cycled up) water from the system. EVAPCO recommends an automated conductivity controller to maximize the water efficiency of your system. **If EVAPCO factory mounted water systems are not utilized**, based on recommendations from your water treatment company, the conductivity controller should open and close a motorized ball or solenoid valve to maintain the conductivity of the recirculating water. If a manual valve is used to control the rate of bleed it should be set to maintain the conductivity of the recirculating water during periods of peak load at the maximum level recommended by your water treatment company.

Water Treatment

The water treatment program prescribed for the given conditions must be compatible with the unit's materials of construction, including any galvanized components. The initial commissioning and passivation period is a critical time for maximizing the service life of galvanized equipment. EVAPCO recommends that the site specific water treatment protocol includes a passivation procedure which details water chemistry, any necessary chemical addition, and visual inspections during the first six (6) to twelve (12) weeks of operation. During this passivation period, recirculating water pH should be maintained above 7.0 and below 8.0 at all times. Batch feeding of chemicals is not recommended.

Control of Biological Contaminants

Evaporative cooling equipment should be inspected regularly to ensure good microbiological control. Inspections should include both monitoring of microbial populations via culturing techniques and visual inspections for evidence of biofouling. Poor microbiological control can result in loss of heat transfer efficiency, increase corrosion potential, and increase the risk of pathogens such as those that cause Legionnaires' disease. Your site specific water treatment protocol should include procedures for routine operation, startup after a shut-down period, and system lay-up, if applicable. If excessive microbiological contamination is detected, a more aggressive mechanical cleaning and/or water treatment program should be undertaken.

LSWE 4-2F6 to 4-5J9

LSWE 4-3H12 to 4-5M18

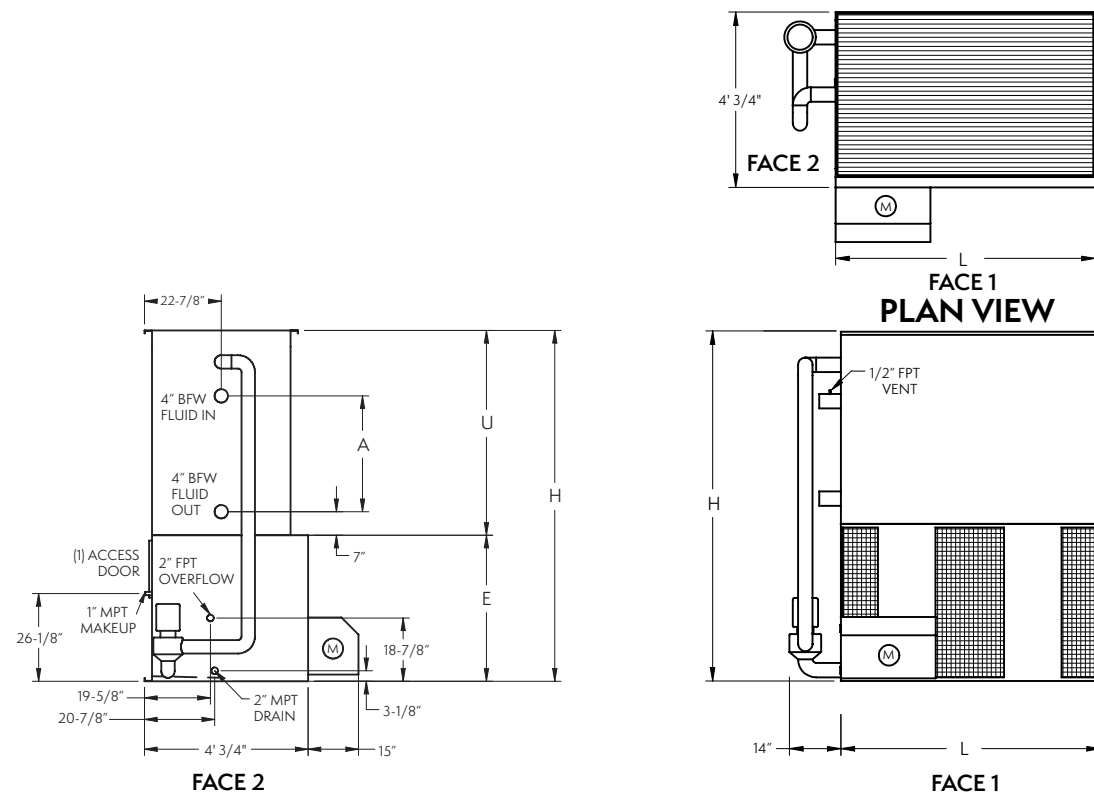

NOTE: The number of coil connections doubles when the flow rate exceeds 450 gpm on 4x6 and 4x9 models. This required option is referred to as the High Flow coil configuration.

Model No. †	WEIGHTS (LBS)			FANS		SPRAY PUMP		Coil Volume (Gallons)	REMOTE SUMP Δ			DIMENSIONS ▲				
	Shipping	Heaviest Section*	Operating	HP	CFM	HP	GPM		Gallons Req'd**	Conn. Size	Operating Weight (lbs)	Height H	Length L	Lower E	Upper U	Coil A
LSWE 4-2F6	2,360	1,330††	3,290	3	10,200	3/4	120	33	80	4"	2,870	6'10"	5'11-7/8"	3'7-1/2"	3'2-1/2"	12"
LSWE 4-2G6	2,370	1,340††	3,300	5	12,100	3/4	120	33	80	4"	2,880	6'10"	5'11-7/8"	3'7-1/2"	3'2-1/2"	12"
LSWE 4-2H6	2,420	1,390††	3,350	7.5	13,900	3/4	120	33	80	4"	2,930	6'10"	5'11-7/8"	3'7-1/2"	3'2-1/2"	12"
LSWE 4-3F6	2,720	1,690	3,770	3	10,000	3/4	120	47	80	4"	3,340	7'5-1/2"	5'11-7/8"	3'7-1/2"	3'10"	19-1/2"
LSWE 4-3G6	2,730	1,700	3,780	5	11,900	3/4	120	47	80	4"	3,350	7'5-1/2"	5'11-7/8"	3'7-1/2"	3'10"	19-1/2"
LSWE 4-3H6	2,780	1,750	3,830	7.5	13,600	3/4	120	47	80	4"	3,400	7'5-1/2"	5'11-7/8"	3'7-1/2"	3'10"	19-1/2"
LSWE 4-3I6	2,800	1,770	3,850	10	15,000	3/4	120	47	80	4"	3,420	7'5-1/2"	5'11-7/8"	3'7-1/2"	3'10"	19-1/2"
LSWE 4-4F6	3,070	2,040	4,230	3	9,800	3/4	120	60	80	4"	3,800	8'1"	5'11-7/8"	3'7-1/2"	4'5-1/2"	27"
LSWE 4-4G6	3,080	2,050	4,240	5	11,700	3/4	120	60	80	4"	3,810	8'1"	5'11-7/8"	3'7-1/2"	4'5-1/2"	27"
LSWE 4-4H6	3,130	2,100	4,290	7.5	13,400	3/4	120	60	80	4"	3,860	8'1"	5'11-7/8"	3'7-1/2"	4'5-1/2"	27"
LSWE 4-4I6	3,150	2,120	4,310	10	14,700	3/4	120	60	80	4"	3,880	8'1"	5'11-7/8"	3'7-1/2"	4'5-1/2"	27"
LSWE 4-5G6	3,440	2,410	4,710	5	11,400	3/4	120	74	80	4"	4,290	8'8-1/2"	5'11-7/8"	3'7-1/2"	5'1"	34-1/2"
LSWE 4-5H6	3,490	2,460	4,760	7.5	13,100	3/4	120	74	80	4"	4,340	8'8-1/2"	5'11-7/8"	3'7-1/2"	5'1"	34-1/2"
LSWE 4-5I6	3,510	2,480	4,780	10	14,400	3/4	120	74	80	4"	4,360	8'8-1/2"	5'11-7/8"	3'7-1/2"	5'1"	34-1/2"
LSWE 4-3G9	3,750	2,370	5,380	5	15,600	1	180	68	120	6"	4,780	7'5-1/2"	8'11-1/4"	3'7-1/2"	3'10"	19-1/2"
LSWE 4-3H9	3,800	2,420	5,380	7.5	17,800	1	180	68	120	6"	4,830	7'5-1/2"	8'11-1/4"	3'7-1/2"	3'10"	19-1/2"
LSWE 4-3I9	3,820	2,440	5,400	10	19,600	1	180	68	120	6"	4,850	7'5-1/2"	8'11-1/4"	3'7-1/2"	3'10"	19-1/2"
LSWE 4-3J9	3,940	2,560	5,520	15	22,500	1	180	68	120	6"	4,970	7'5-1/2"	8'11-1/4"	3'7-1/2"	3'10"	19-1/2"
LSWE 4-4H9	4,310	2,930	6,060	7.5	17,500	1	180	89	120	6"	5,510	8'1"	8'11-1/4"	3'7-1/2"	4'5-1/2"	27"
LSWE 4-4I9	4,330	2,950	6,080	10	19,200	1	180	89	120	6"	5,530	8'1"	8'11-1/4"	3'7-1/2"	4'5-1/2"	27"
LSWE 4-4J9	4,450	3,070	6,200	15	22,000	1	180	89	120	6"	5,650	8'1"	8'11-1/4"	3'7-1/2"	4'5-1/2"	27"
LSWE 4-5H9	4,840	3,460	6,770	7.5	17,100	1	180	109	120	6"	6,210	8'8-1/2"	8'11-1/4"	3'7-1/2"	5'1"	34-1/2"
LSWE 4-5I9	4,860	3,480	6,790	10	18,800	1	180	109	120	6"	6,230	8'8-1/2"	8'11-1/4"	3'7-1/2"	5'1"	34-1/2"
LSWE 4-5J9	4,980	3,600	6,910	15	21,600	1	180	109	120	6"	6,350	8'8-1/2"	8'11-1/4"	3'7-1/2"	5'1"	34-1/2"

† Model Number will end in "-Z" for units with Series Flow piping configuration. Series Flow units may require additional coil connections and will require crossover piping. Model numbers will include "I" for units with Intake Attenuation, "D" for units with Discharge Attenuation, "F" for units with Full Sound Attenuation, "T" for units with a Tapered Discharge Hood, and "S" for units with an option that negates CTI Certification.
 †† Model normally ships in one piece.
 * Heaviest section is the coil section.
 ** Gallons shown is water in suspension in unit and piping. Allow for additional water in bottom of remote sump to cover pump suction and strainer during operation (12" would normally be sufficient).
 Δ When a remote sump arrangement is selected, the spray pump, suction strainer and associated piping are omitted; the unit is provided with an oversized outlet to facilitate drainage to the remote sump.
 ▲ Unit dimensions and coil connections may vary slightly from catalog. See factory certified prints for dimensions, quantity of coil connections, and piping configuration. Coil connections are 4" bevel for weld (BFW), also available as options. Other connection types such as grooved for mechanical coupling or flanged are also available as options.

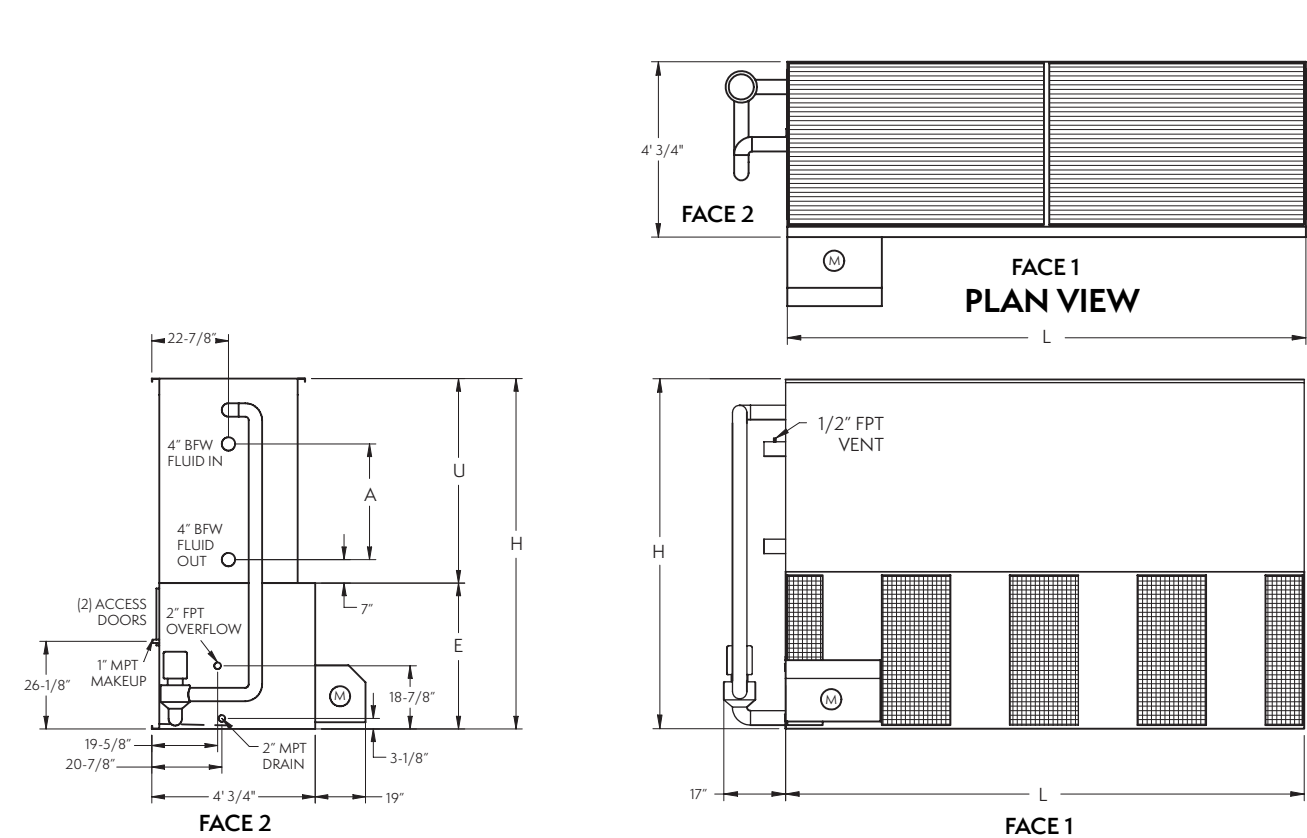

NOTE: The number of coil connections doubles when the flow rate exceeds 450 gpm on 4x6 and 4x9 models. This required option is referred to as the High Flow coil configuration.

Model No. †	WEIGHTS (LBS)			FANS		SPRAY PUMP		Coil Volume (Gallons)	REMOTE SUMP Δ			DIMENSIONS ▲				
	Shipping	Heaviest Section*	Operating	HP	CFM	HP	GPM		Gallons Req'd**	Conn. Size	Operating Weight (lbs)	Height H	Length L	Lower E	Upper U	Coil A
LSWE 4-3H12	4,970	3,160	6,990	7.5	21,600	1.5	245	89	170	6"	6,380	7'5-1/2"	11'11-3/4"	3'7-1/2"	3'10"	19-1/2"
LSWE 4-3I12	4,990	3,180	7,010	10	23,800	1.5	245	89	170	6"	6,400	7'5-1/2"	11'11-3/4"	3'7-1/2"	3'10"	19-1/2"
LSWE 4-3J12	5,110	3,300	7,130	15	27,300	1.5	245	89	170	6"	6,520	7'5-1/2"	11'11-3/4"	3'7-1/2"	3'10"	19-1/2"
LSWE 4-3K12	5,170	3,360	7,190	20	30,000	1.5	245	89	170	6"	6,580	7'5-1/2"	11'11-3/4"	3'7-1/2"	3'10"	19-1/2"
LSWE 4-4I12	5,680	3,870	7,930	10	23,300	1.5	245	117	170	6"	7,320	8'1"	11'11-3/4"	3'7-1/2"	4'5-1/2"	27"
LSWE 4-4J12	5,800	3,990	8,050	15	26,700	1.5	245	117	170	6"	7,440	8'1"	11'11-3/4"	3'7-1/2"	4'5-1/2"	27"
LSWE 4-4K12	5,860	4,050	8,110	20	29,400	1.5	245	117	170	6"	7,500	8'1"	11'11-3/4"	3'7-1/2"	4'5-1/2"	27"
LSWE 4-5I12	6,330	4,520	8,810	10	22,900	1.5	245	145	170	6"	8,230	8'8-1/2"	11'11-3/4"	3'7-1/2"	5'1"	34-1/2"
LSWE 4-5J12	6,450	4,640	8,930	15	26,200	1.5	245	145	170	6"	8,350	8'8-1/2"	11'11-3/4"	3'7-1/2"	5'1"	34-1/2"
LSWE 4-5K12	6,510	4,700	8,990	20	28,800	1.5	245	145	170	6"	8,410	8'8-1/2"	11'11-3/4"	3'7-1/2"	5'1"	34-1/2"
LSWE 4-3I18	7,170	4,590	10,070	10	31,300	2	365	132	250	8"	8,880	7'5-1/2"	18"	3'7-1/2"	3'10"	19-1/2"
LSWE 4-3J18	7,290	4,710	10,190	15	35,800	2	365	132	250	8"	9,000	7'5-1/2"	18"	3'7-1/2"	3'10"	19-1/2"
LSWE 4-3K18	7,350	4,770	10,250	20	39,400	2	365	132	250	8"	9,060	7'5-1/2"	18"	3'7-1/2"	3'10"	19-1/2"
LSWE 4-3L18	7,380	4,800	10,280	25	42,400	2	365	132	250	8"	9,090	7'5-1/2"	18"	3'7-1/2"	3'10"	19-1/2"
LSWE 4-4I18	8,300	5,720	11,550	15	35,100	2	365	174	250	8"	10,370	8'1"	18"	3'7-1/2"	4'5-1/2"	27"
LSWE 4-4K18	8,360	5,780	11,610	20	38,600	2	365	174	250	8"	10,430	8'1"	18"	3'7-1/2"	4'5-1/2"	27"
LSWE 4-4L18	8,390	5,810	11,640	25	41,600	2	365	174	250	8"	10,460	8'1"	18"	3'7-1/2"	4'5-1/2"	27"
LSWE 4-5J18	9,290	6,710	12,890	15	34,400	2	365	215	250	8"	11,710	8'8-1/2"	18"	3'7-1/2"	5'1"	34-1/2"
LSWE 4-5K18	9,350	6,770	12,950	20	37,800	2	365	215	250	8"	11,770	8'8-1/2"	18"	3'7-1/2"	5'1"	34-1/2"
LSWE 4-5L18	9,380	6,800	12,980	25	40,800	2	365	215	250	8"	11,800	8'8-1/2"	18"	3'7-1/2"	5'1"	34-1/2"
LSWE 4-5M18	9,430	6,850	13,030	30	43,300	2	365	215	250	8"	11,850	8'8-1/2"	18"	3'7-1/2"	5'1"	34-1/2"

† Model Number will end in "-Z" for units with Series Flow piping configuration. Series Flow units may require additional coil connections and will require crossover piping. Model numbers will include "I" for units with Intake Attenuation, "D" for units with Discharge Attenuation, "F" for units with Full Sound Attenuation, "T" for units with a Tapered Discharge Hood, and "S" for units with an option that negates CTI Certification.
 * Heaviest section is the coil section.
 ** Gallons shown is water in suspension in unit and piping. Allow for additional water in bottom of remote sump to cover pump suction and strainer during operation (12" would normally be sufficient).
 Δ When a remote sump arrangement is selected, the spray pump, suction strainer and associated piping are omitted; the unit is provided with an oversized outlet to facilitate drainage to the remote sump.
 ▲ Unit dimensions and coil connections may vary slightly from catalog. See factory certified prints for dimensions, quantity of coil connections, and piping configuration. Coil connections are 4" bevel for weld (BFW), also available as options. Other connection types such as grooved for mechanical coupling or flanged are also available as options.

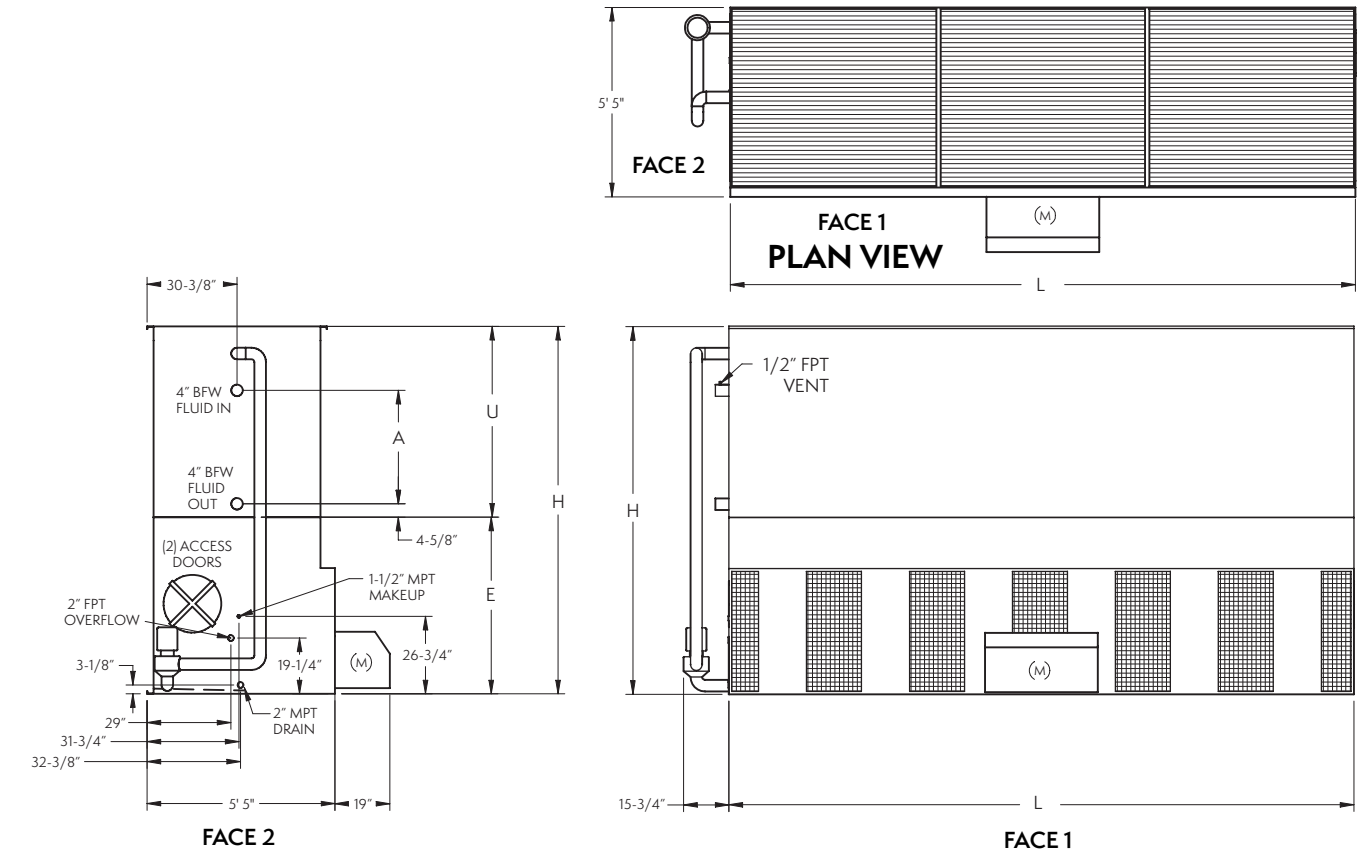
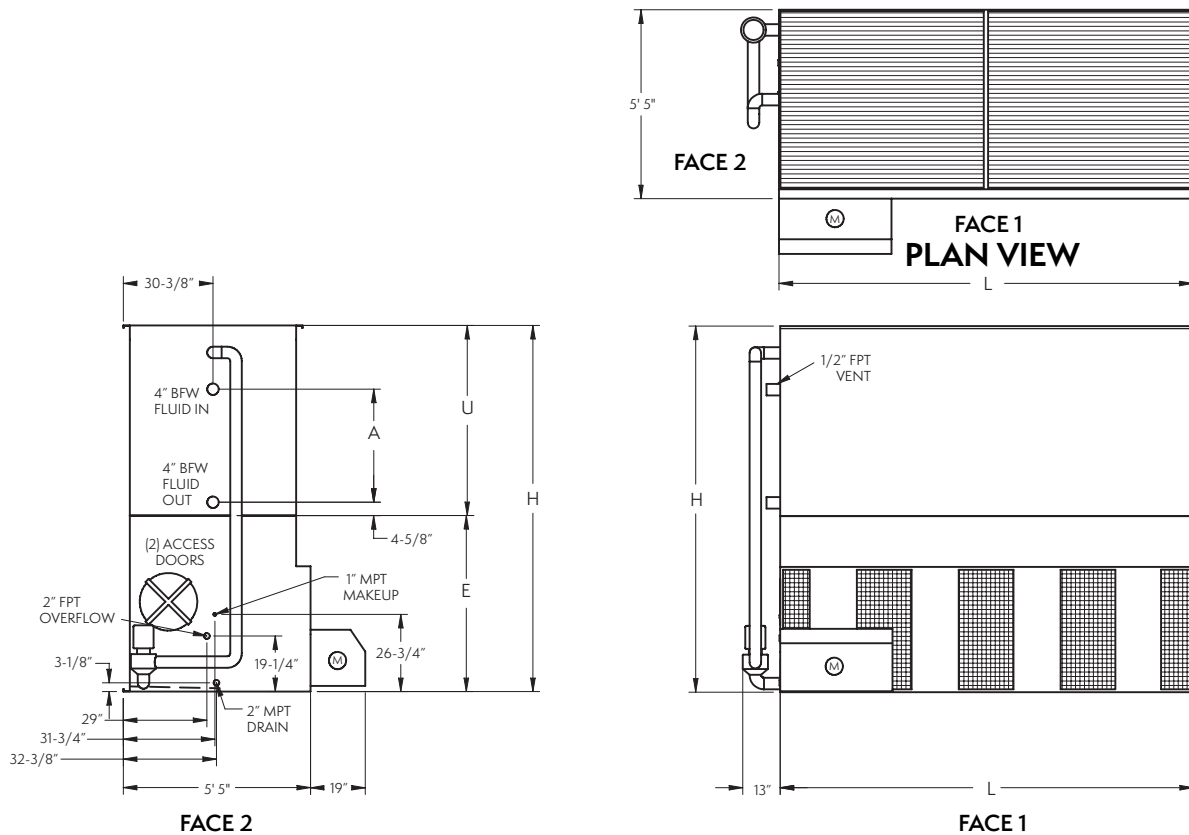

NOTE: The number of coil connections doubles when the flow rate exceeds 450 gpm on 5x12 models. This required option is referred to as the High Flow coil configuration.

NOTE: The number of coil connections doubles when the flow rate exceeds 450 gpm on 5x18 models. This required option is referred to as the High Flow coil configuration.

Model No. †	WEIGHTS (LBS)			FANS		SPRAY PUMP		Coil Volume (Gallons)	REMOTE SUMP Δ			DIMENSIONS ▲				
	Shipping	Heaviest Section*	Operating	HP	CFM	HP	GPM		Gallons Req'd**	Conn. Size	Operating Weight (lbs)	Height H	Length L	Lower E	Upper U	Coil A
LSWE 5-3I12	6,540	4,150	10,020	10	29,900	2	345	127	230	6"	8,300	9' 2-1/8"	11' 11-1/2"	5' 1-1/8"	4' 1"	22-1/4"
LSWE 5-3J12	6,660	4,270	10,140	15	34,200	2	345	127	230	6"	8,420	9' 2-1/8"	11' 11-1/2"	5' 1-1/8"	4' 1"	22-1/4"
LSWE 5-3K12	6,720	4,330	10,200	20	37,700	2	345	127	230	6"	8,480	9' 2-1/8"	11' 11-1/2"	5' 1-1/8"	4' 1"	22-1/4"
LSWE 5-3L12	6,750	4,360	10,230	25	40,600	2	345	127	230	6"	8,510	9' 2-1/8"	11' 11-1/2"	5' 1-1/8"	4' 1"	22-1/4"
LSWE 5-4I12	7,500	5,110	11,310	10	29,300	2	345	166	230	6"	9,620	9' 10-5/8"	11' 11-1/2"	5' 1-1/8"	4' 9-1/2"	30-3/4"
LSWE 5-4J12	7,620	5,230	11,430	15	33,600	2	345	166	230	6"	9,740	9' 10-5/8"	11' 11-1/2"	5' 1-1/8"	4' 9-1/2"	30-3/4"
LSWE 5-4K12	7,680	5,290	11,490	20	36,900	2	345	166	230	6"	9,800	9' 10-5/8"	11' 11-1/2"	5' 1-1/8"	4' 9-1/2"	30-3/4"
LSWE 5-4L12	7,710	5,320	11,520	25	39,800	2	345	166	230	6"	9,830	9' 10-5/8"	11' 11-1/2"	5' 1-1/8"	4' 9-1/2"	30-3/4"
LSWE 5-5I12	8,620	6,230	12,760	15	32,900	2	345	206	230	6"	11,080	10' 7-1/8"	11' 11-1/2"	5' 1-1/8"	5' 6"	39-1/4"
LSWE 5-5K12	8,680	6,290	12,820	20	36,200	2	345	206	230	6"	11,140	10' 7-1/8"	11' 11-1/2"	5' 1-1/8"	5' 6"	39-1/4"
LSWE 5-5L12	8,710	6,320	12,850	25	39,000	2	345	206	230	6"	11,170	10' 7-1/8"	11' 11-1/2"	5' 1-1/8"	5' 6"	39-1/4"
LSWE 5-6J12	9,600	7,210	14,070	15	32,200	2	345	245	230	6"	12,400	11' 3-5/8"	11' 11-1/2"	5' 1-1/8"	6' 2-1/2"	47-3/4"
LSWE 5-6K12	9,660	7,270	14,130	20	35,500	2	345	245	230	6"	12,460	11' 3-5/8"	11' 11-1/2"	5' 1-1/8"	6' 2-1/2"	47-3/4"
LSWE 5-6L12	9,690	7,300	14,160	25	38,200	2	345	245	230	6"	12,490	11' 3-5/8"	11' 11-1/2"	5' 1-1/8"	6' 2-1/2"	47-3/4"
LSWE 5-6M12	9,740	7,350	14,210	30	40,600	2	345	245	230	6"	12,540	11' 3-5/8"	11' 11-1/2"	5' 1-1/8"	6' 2-1/2"	47-3/4"
LSWE 5-7J12	10,720	8,330	15,520	15	31,500	2	345	285	230	6"	13,850	11' 3-5/8"	11' 11-1/2"	5' 1-1/8"	6' 2-1/2"	47-3/4"
LSWE 5-7K12	10,780	8,390	15,580	20	34,700	2	345	285	230	6"	13,910	11' 3-5/8"	11' 11-1/2"	5' 1-1/8"	6' 2-1/2"	47-3/4"
LSWE 5-7L12	10,810	8,420	15,610	25	37,400	2	345	285	230	6"	13,940	11' 3-5/8"	11' 11-1/2"	5' 1-1/8"	6' 2-1/2"	47-3/4"
LSWE 5-7M12	10,860	8,470	15,660	30	39,700	2	345	285	230	6"	13,990	11' 3-5/8"	11' 11-1/2"	5' 1-1/8"	6' 2-1/2"	47-3/4"

Model No. †	WEIGHTS (LBS)			FANS		SPRAY PUMP		Coil Volume (Gallons)	REMOTE SUMP Δ			DIMENSIONS ▲				
	Shipping	Heaviest Section*	Operating	HP	CFM	HP	GPM		Gallons Req'd**	Conn. Size	Operating Weight (lbs)	Height H	Length L	Lower E	Upper U	Coil A
LSWE 5-3J18	9,830	6,250	14,820	15	45,000	3	515	187	340	8"	11,840	9' 2-1/8"	18' 1/8"	5' 1-1/8"	4' 1"	22-1/4"
LSWE 5-3K18	9,890	6,310	14,880	20	49,500	3	515	187	340	8"	11,900	9' 2-1/8"	18' 1/8"	5' 1-1/8"	4' 1"	22-1/4"
LSWE 5-3L18	9,920	6,340	14,910	25	53,300	3	515	187	340	8"	11,930	9' 2-1/8"	18' 1/8"	5' 1-1/8"	4' 1"	22-1/4"
LSWE 5-3M18	9,970	6,390	14,960	30	56,600	3	515	187	340	8"	11,980	9' 2-1/8"	18' 1/8"	5' 1-1/8"	4' 1"	22-1/4"
LSWE 5-4K18	11,330	7,750	16,810	20	48,500	3	515	247	340	8"	13,830	9' 10-5/8"	18' 1/8"	5' 1-1/8"	4' 9-1/2"	30-3/4"
LSWE 5-4L18	11,360	7,780	16,840	25	52,300	3	515	247	340	8"	13,860	9' 10-5/8"	18' 1/8"	5' 1-1/8"	4' 9-1/2"	30-3/4"
LSWE 5-4M18	11,410	7,830	16,890	30	55,500	3	515	247	340	8"	13,910	9' 10-5/8"	18' 1/8"	5' 1-1/8"	4' 9-1/2"	30-3/4"
LSWE 5-4N18	11,570	7,990	17,050	40	61,100	3	515	247	340	8"	14,070	9' 10-5/8"	18' 1/8"	5' 1-1/8"	4' 9-1/2"	30-3/4"
LSWE 5-5K18	12,840	9,260	18,820	20	47,500	3	515	306	340	8"	15,860	10' 7-1/8"	18' 1/8"	5' 1-1/8"	5' 6"	39-1/4"
LSWE 5-5L18	12,870	9,290	18,850	25	51,200	3	515	306	340	8"	15,890	10' 7-1/8"	18' 1/8"	5' 1-1/8"	5' 6"	39-1/4"
LSWE 5-5M18	12,920	9,340	18,900	30	54,400	3	515	306	340	8"	15,940	10' 7-1/8"	18' 1/8"	5' 1-1/8"	5' 6"	39-1/4"
LSWE 5-5N18	13,080	9,500	19,060	40	59,900	3	515	306	340	8"	16,100	10' 7-1/8"	18' 1/8"	5' 1-1/8"	5' 6"	39-1/4"
LSWE 5-6L18	14,340	10,760	20,820	25	50,200	3	515	366	340	8"	17,890	11' 3-5/8"	18' 1/8"	5' 1-1/8"	6' 2-1/2"	47-3/4"
LSWE 5-6M18	14,390	10,810	20,870	30	53,300	3	515	366	340	8"	17,940	11' 3-5/8"	18' 1/8"	5' 1-1/8"	6' 2-1/2"	47-3/4"
LSWE 5-6N18	14,550	10,970	21,030	40	58,700	3	515	366	340	8"	18,100	11' 3-5/8"	18' 1/8"	5' 1-1/8"	6' 2-1/2"	47-3/4"
LSWE 5-7L18	16,030	12,450	23,010	25	49,100	3	515	426	340	8"	20,070	11' 3-5/8"	18' 1/8"	5' 1-1/8"	6' 2-1/2"	47-3/4"
LSWE 5-7M18	16,080	12,500	23,060	30	52,200	3	515	426	340	8"	20,120	11' 3-5/8"	18' 1/8"	5' 1-1/8"	6' 2-1/2"	47-3/4"
LSWE 5-7N18	16,240	12,660	23,220	40	57,400	3	515	426	340	8"	20,280	11' 3-5/8"	18' 1/8"	5' 1-1/8"	6' 2-1/2"	47-3/4"

† Model Number will end in "-Z" for units with Series Flow piping configuration. Series Flow units may require additional coil connections and will require crossover piping. Model numbers will include "I" for units with Intake Attenuation, "D" for units with Discharge Attenuation, "F" for units with Full Sound Attenuation, "T" for units with a Tapered Discharge Hood, and "S" for units with an option that negates CTI Certification.

* Heaviest section is the coil section.

** Gallons shown is water in suspension in unit and piping. Allow for additional water in bottom of remote sump to cover pump suction and strainer during operation (12" would normally be sufficient).

Δ When a remote sump arrangement is selected, the spray pump, suction strainer and associated piping are omitted; the unit is provided with an oversized outlet to facilitate drainage to the remote sump.

▲ Unit dimensions and coil connections may vary slightly from catalog. See factory certified prints for dimensions, quantity of coil connections, and piping configuration. Coil connections are 4" bevel for weld (BFW), also available as options. Other connection types such as grooved for mechanical coupling or flanged are also available as options.

† Model Number will end in "-Z" for units with Series Flow piping configuration. Series Flow units may require additional coil connections and will require crossover piping. Model numbers will include "I" for units with Intake Attenuation, "D" for units with Discharge Attenuation, "F" for units with Full Sound Attenuation, "T" for units with a Tapered Discharge Hood, and "S" for units with an option that negates CTI Certification.

* Heaviest section is the coil section.

** Gallons shown is water in suspension in unit and piping. Allow for additional water in bottom of remote sump to cover pump suction and strainer during operation (12" would normally be sufficient).

Δ When a remote sump arrangement is selected, the spray pump, suction strainer and associated piping are omitted; the unit is provided with an oversized outlet to facilitate drainage to the remote sump.

▲ Unit dimensions and coil connections may vary slightly from catalog. See factory certified prints for dimensions, quantity of coil connections, and piping configuration. Coil connections are 4" bevel for weld (BFW), also available as options. Other connection types such as grooved for mechanical coupling or flanged are also available as options.

LSWE 8P-3K12 to 8P-7O12

LSWE 8P-3M18 to 8P-7P18

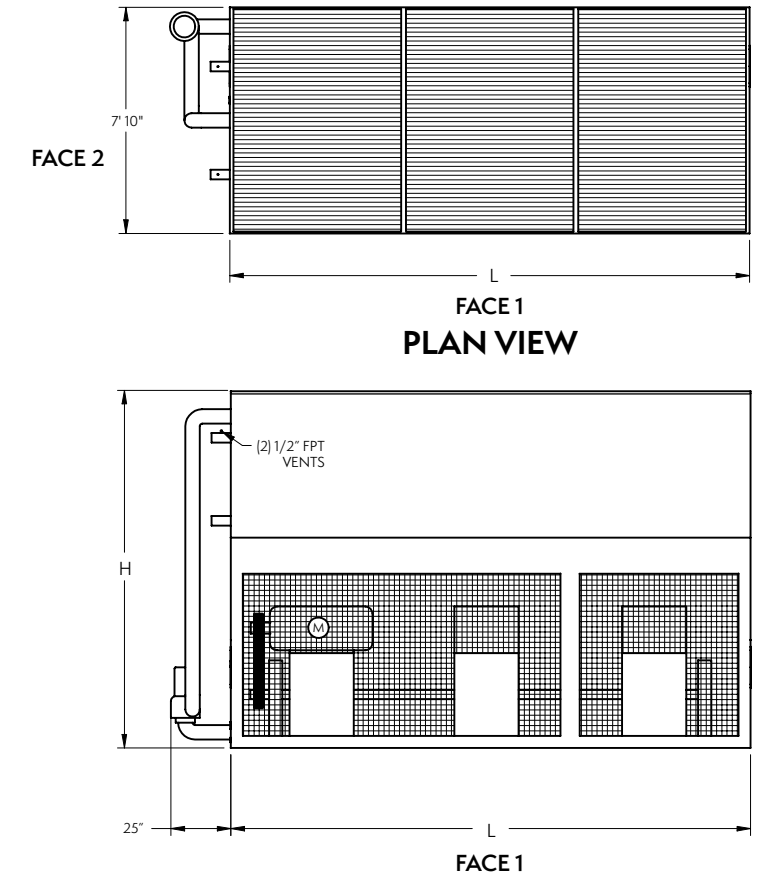
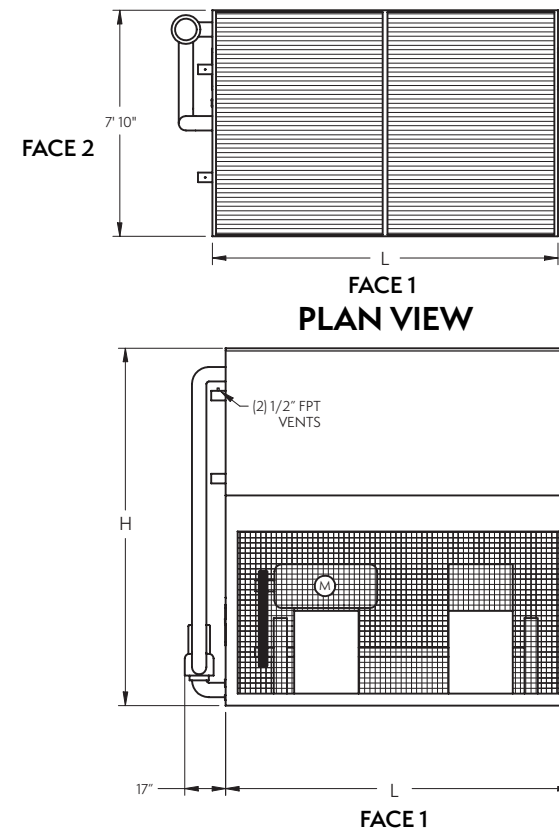

NOTE: The number of coil connections doubles when the flow rate exceeds 900 gpm on 8Px12 models. This required option is referred to as the High Flow coil configuration.

Model No. †	WEIGHTS (LBS)			FANS		SPRAY PUMP		Coil Volume (Gallons)	REMOTE SUMP Δ			DIMENSIONS ▲				
	Shipping	Heaviest Section*	Operating	HP	CFM	HP	GPM		Gallons Req'd**	Conn. Size	Operating Weight (lbs)	Height H	Length L	Lower E	Upper U	Coil A
LSWE 8P-3K12	9,660	6,230	14,700	20	48,600	5	570	200	360	10"	12,730	11' 1-5/8"	11' 11-3/4"	7' 3-3/8"	3' 10-1/4"	19-1/2"
LSWE 8P-3L12	9,690	6,260	14,730	25	52,400	5	570	200	360	10"	12,760	11' 1-5/8"	11' 11-3/4"	7' 3-3/8"	3' 10-1/4"	19-1/2"
LSWE 8P-3M12	9,740	6,310	14,780	30	55,700	5	570	200	360	10"	12,810	11' 1-5/8"	11' 11-3/4"	7' 3-3/8"	3' 10-1/4"	19-1/2"
LSWE 8P-3N12	9,900	6,470	14,940	40	61,300	5	570	200	360	10"	12,970	11' 1-5/8"	11' 11-3/4"	7' 3-3/8"	3' 10-1/4"	19-1/2"
LSWE 8P-4L12	11,150	7,720	16,710	25	51,300	5	570	262	360	10"	14,850	11' 9-1/8"	11' 11-3/4"	7' 3-3/8"	4' 5-3/4"	27"
LSWE 8P-4M12	11,200	7,770	16,760	30	54,600	5	570	262	360	10"	14,900	11' 9-1/8"	11' 11-3/4"	7' 3-3/8"	4' 5-3/4"	27"
LSWE 8P-4N12	11,360	7,930	16,920	40	60,100	5	570	262	360	10"	15,060	11' 9-1/8"	11' 11-3/4"	7' 3-3/8"	4' 5-3/4"	27"
LSWE 8P-4O12	11,370	7,940	16,930	50	64,700	5	570	262	360	10"	15,070	11' 9-1/8"	11' 11-3/4"	7' 3-3/8"	4' 5-3/4"	27"
LSWE 8P-5M12	12,610	9,180	18,690	30	53,500	5	570	324	360	10"	16,940	12' 4-5/8"	11' 11-3/4"	7' 3-3/8"	5' 1-1/4"	34-1/2"
LSWE 8P-5N12	12,770	9,340	18,850	40	58,900	5	570	324	360	10"	17,100	12' 4-5/8"	11' 11-3/4"	7' 3-3/8"	5' 1-1/4"	34-1/2"
LSWE 8P-5O12	12,780	9,350	18,860	50	63,400	5	570	324	360	10"	17,110	12' 4-5/8"	11' 11-3/4"	7' 3-3/8"	5' 1-1/4"	34-1/2"
LSWE 8P-6M12	14,070	10,640	20,670	30	52,400	5	570	386	360	10"	19,040	13' 1/8"	11' 11-3/4"	7' 3-3/8"	5' 8-3/4"	42"
LSWE 8P-6N12	14,230	10,800	20,830	40	57,700	5	570	386	360	10"	19,200	13' 1/8"	11' 11-3/4"	7' 3-3/8"	5' 8-3/4"	42"
LSWE 8P-6O12	14,240	10,810	20,840	50	62,100	5	570	386	360	10"	19,210	13' 1/8"	11' 11-3/4"	7' 3-3/8"	5' 8-3/4"	42"
LSWE 8P-7M12	15,550	12,120	22,670	30	51,300	5	570	448	360	10"	21,040	13' 2-1/8"	11' 11-3/4"	7' 3-3/8"	5' 10-3/4"	47-3/4"
LSWE 8P-7N12	15,710	12,280	22,830	40	56,400	5	570	448	360	10"	21,200	13' 2-1/8"	11' 11-3/4"	7' 3-3/8"	5' 10-3/4"	47-3/4"
LSWE 8P-7O12	15,720	12,290	22,840	50	60,800	5	570	448	360	10"	21,210	13' 2-1/8"	11' 11-3/4"	7' 3-3/8"	5' 10-3/4"	47-3/4"

† Model Number will end in "-Z" for units with Series Flow piping configuration. Series Flow units may require additional coil connections and will require crossover piping. Model numbers will include "I" for units with Intake Attenuation, "D" for units with Discharge Attenuation, "F" for units with Full Sound Attenuation, "T" for units with a Tapered Discharge Hood, and "S" for units with an option that negates CTI Certification.

* Heaviest section is the coil section.

** Gallons shown is water in suspension in unit and piping. Allow for additional water in bottom of remote sump to cover pump suction and strainer during operation (12" would normally be sufficient).

Δ When a remote sump arrangement is selected, the spray pump, suction strainer and associated piping are omitted; the unit is provided with an oversized outlet to facilitate drainage to the remote sump.

▲ Unit dimensions and coil connections may vary slightly from catalog. See factory certified prints for dimensions, quantity of coil connections, and piping configuration. Coil connections are 4" bevel for weld (BFW), also available as options. Other connection types such as grooved for mechanical coupling or flanged are also available as options.

NOTE: The number of coil connections doubles when the flow rate exceeds 900 gpm on 8Px18 models. This required option is referred to as the High Flow coil configuration.

Model No. †	WEIGHTS (LBS)			FANS		SPRAY PUMP		Coil Volume (Gallons)	REMOTE SUMP Δ			DIMENSIONS ▲				
	Shipping	Heaviest Section*	Operating	HP	CFM	HP	GPM		Gallons Req'd**	Conn. Size	Operating Weight (lbs)	Height H	Length L	Lower E	Upper U	Coil A
LSWE 8P-3M18	13,940	9,140	21,540	30	72,800	7.5	840	295	530	12"	18,640	11' 1-5/8"	18'	7' 3-3/8"	3' 10-1/4"	19-1/2"
LSWE 8P-3N18	14,100	9,300	21,700	40	80,100	7.5	840	295	530	12"	18,800	11' 1-5/8"	18'	7' 3-3/8"	3' 10-1/4"	19-1/2"
LSWE 8P-3O18	14,110	9,310	21,710	50	86,300	7.5	840	295	530	12"	18,810	11' 1-5/8"	18'	7' 3-3/8"	3' 10-1/4"	19-1/2"
LSWE 8P-3P18	14,310	9,510	21,910	60	91,700	7.5	840	295	530	12"	19,010	11' 1-5/8"	18'	7' 3-3/8"	3' 10-1/4"	19-1/2"
LSWE 8P-4M18	16,130	11,330	24,510	30	71,300	7.5	840	389	530	12"	21,790	11' 9-1/8"	18'	7' 3-3/8"	4' 5-3/4"	27"
LSWE 8P-4N18	16,290	11,490	24,670	40	78,500	7.5	840	389	530	12"	21,950	11' 9-1/8"	18'	7' 3-3/8"	4' 5-3/4"	27"
LSWE 8P-4O18	16,300	11,500	24,680	50	84,600	7.5	840	389	530	12"	21,960	11' 9-1/8"	18'	7' 3-3/8"	4' 5-3/4"	27"
LSWE 8P-4P18	16,500	11,700	24,880	60	89,900	7.5	840	389	530	12"	22,160	11' 9-1/8"	18'	7' 3-3/8"	4' 5-3/4"	27"
LSWE 8P-5N18	18,380	13,580	27,540	40	77,000	7.5	840	483	530	12"	24,990	12' 4-5/8"	18'	7' 3-3/8"	5' 1-1/4"	34-1/2"
LSWE 8P-5O18	18,390	13,590	27,550	50	82,900	7.5	840	483	530	12"	25,000	12' 4-5/8"	18'	7' 3-3/8"	5' 1-1/4"	34-1/2"
LSWE 8P-5P18	18,590	13,790	27,750	60	88,100	7.5	840	483	530	12"	25,200	12' 4-5/8"	18'	7' 3-3/8"	5' 1-1/4"	34-1/2"
LSWE 8P-6N18	20,600	15,800	30,550	40	75,400	7.5	840	577	530	12"	28,160	13' 1/8"	18'	7' 3-3/8"	5' 8-3/4"	42"
LSWE 8P-6O18	20,610	15,810	30,560	50	81,200	7.5	840	577	530	12"	28,170	13' 1/8"	18'	7' 3-3/8"	5' 8-3/4"	42"
LSWE 8P-6P18	20,810	16,010	30,760	60	86,300	7.5	840	577	530	12"	28,370	13' 1/8"	18'	7' 3-3/8"	5' 8-3/4"	42"
LSWE 8P-7N18	22,790	17,990	33,520	40	73,800	7.5	840	671	530	12"	31,130	13' 2-1/8"	18'	7' 3-3/8"	5' 10-3/4"	47-3/4"
LSWE 8P-7O18	22,800	18,000	33,530	50	79,500	7.5	840	671	530	12"	31,140	13' 2-1/8"	18'	7' 3-3/8"	5' 10-3/4"	47-3/4"
LSWE 8P-7P18	23,000	18,200	33,730	60	84,500	7.5	840	671	530	12"	31,340	13' 2-1/8"	18'	7' 3-3/8"	5' 10-3/4"	47-3/4"

† Model Number will end in "-Z" for units with Series Flow piping configuration. Series Flow units may require additional coil connections and will require crossover piping. Model numbers will include "I" for units with Intake Attenuation, "D" for units with Discharge Attenuation, "F" for units with Full Sound Attenuation, "T" for units with a Tapered Discharge Hood, and "S" for units with an option that negates CTI Certification.

* Heaviest section is the coil section.

** Gallons shown is water in suspension in unit and piping. Allow for additional water in bottom of remote sump to cover pump suction and strainer during operation (12" would normally be sufficient).

Δ When a remote sump arrangement is selected, the spray pump, suction strainer and associated piping are omitted; the unit is provided with an oversized outlet to facilitate drainage to the remote sump.

▲ Unit dimensions and coil connections may vary slightly from catalog. See factory certified prints for dimensions, quantity of coil connections, and piping configuration. Coil connections are 4" bevel for weld (BFW), also available as options. Other connection types such as grooved for mechanical coupling or flanged are also available as options.

LSWE 8P-3K24 to 8P-7O24

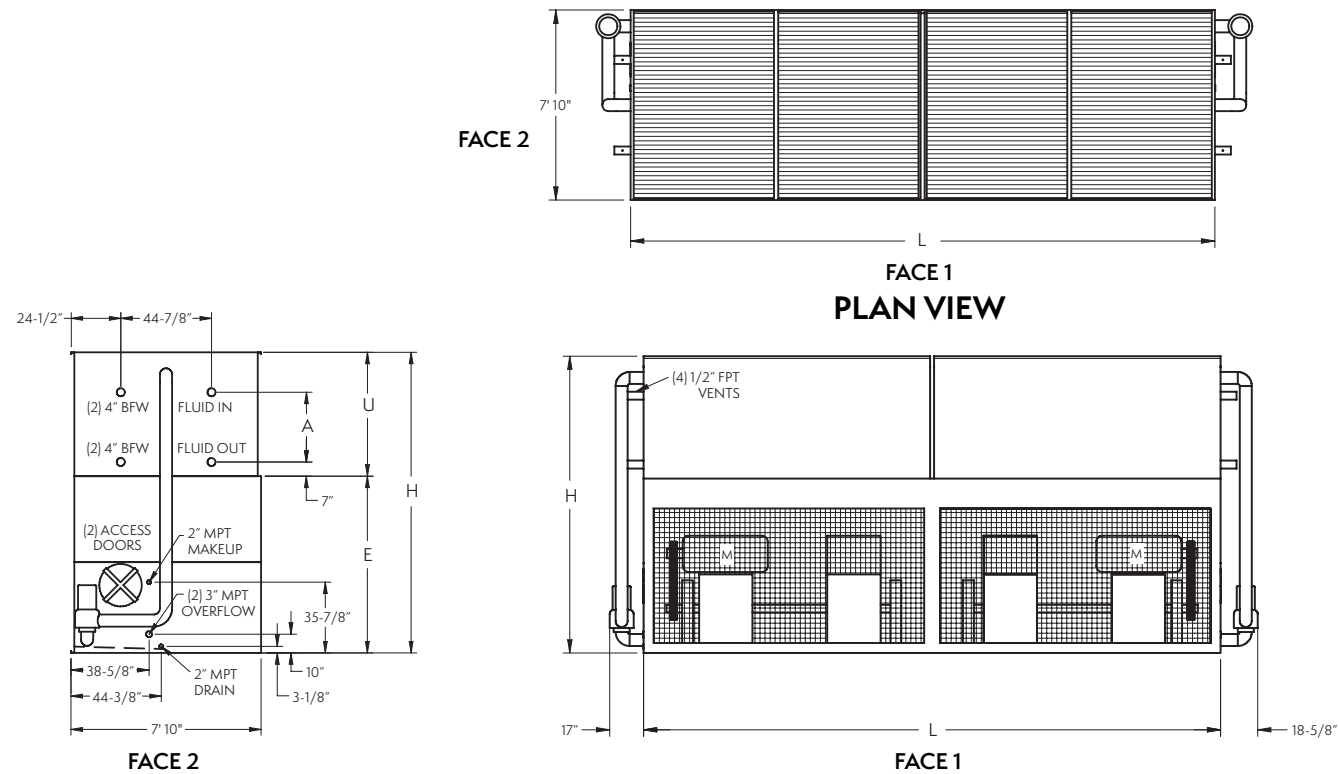

NOTE: The number of coil connections doubles when the flow rate exceeds 1800 gpm on 8Px24 models. This required option is referred to as the High Flow coil configuration.

Model No. †	WEIGHTS (LBS)			FANS		SPRAY PUMP		COIL			REMOTE SUMP Δ					DIMENSIONS ▲				
	Shipping	Heaviest Section*	Operating	HP	CFM	HP	GPM	Volume (Gallons)	Gallons Req'd**	Conn. Size	Operating Weight (lbs)	Height H	Length L	Lower E	Upper U	Coil A				
LSWE 8P-3K24	19,360	6,590	29,510	(2) 20	97,200	(2) 5	1140	400	720	(2) 10"	25,650	11' 1-5/8"	24' 1"	7' 3-3/8"	3' 10-1/4"	19-1/2"				
LSWE 8P-3L24	19,480	6,650	29,630	(2) 25	104,700	(2) 5	1140	400	720	(2) 10"	25,770	11' 1-5/8"	24' 1"	7' 3-3/8"	3' 10-1/4"	19-1/2"				
LSWE 8P-3M24	19,680	6,750††	29,830	(2) 30	111,300	(2) 5	1140	400	720	(2) 10"	25,970	11' 1-5/8"	24' 1"	7' 3-3/8"	3' 10-1/4"	19-1/2"				
LSWE 8P-3N24	20,320	7,070††	30,470	(2) 40	122,500	(2) 5	1140	400	720	(2) 10"	26,610	11' 1-5/8"	24' 1"	7' 3-3/8"	3' 10-1/4"	19-1/2"				
LSWE 8P-4L24	22,380	8,100	33,570	(2) 25	102,700	(2) 5	1140	524	720	(2) 10"	29,970	11' 9-1/8"	24' 1"	7' 3-3/8"	4' 5-3/4"	27"				
LSWE 8P-4M24	22,580	8,200	33,770	(2) 30	109,100	(2) 5	1140	524	720	(2) 10"	30,170	11' 9-1/8"	24' 1"	7' 3-3/8"	4' 5-3/4"	27"				
LSWE 8P-4N24	23,220	8,520	34,410	(2) 40	120,100	(2) 5	1140	524	720	(2) 10"	30,810	11' 9-1/8"	24' 1"	7' 3-3/8"	4' 5-3/4"	27"				
LSWE 8P-4O24	23,260	8,540	34,450	(2) 50	129,400	(2) 5	1140	524	720	(2) 10"	30,850	11' 9-1/8"	24' 1"	7' 3-3/8"	4' 5-3/4"	27"				
LSWE 8P-5M24	25,420	9,620	37,650	(2) 30	106,900	(2) 5	1140	648	720	(2) 10"	34,260	12' 4-5/8"	24' 1"	7' 3-3/8"	5' 1-1/4"	34-1/2"				
LSWE 8P-5N24	26,060	9,940	38,290	(2) 40	117,700	(2) 5	1140	648	720	(2) 10"	34,900	12' 4-5/8"	24' 1"	7' 3-3/8"	5' 1-1/4"	34-1/2"				
LSWE 8P-5O24	26,100	9,960	38,330	(2) 50	126,800	(2) 5	1140	648	720	(2) 10"	34,940	12' 4-5/8"	24' 1"	7' 3-3/8"	5' 1-1/4"	34-1/2"				
LSWE 8P-6M24	28,340	11,080	41,610	(2) 30	104,800	(2) 5	1140	772	720	(2) 10"	38,470	13' 1/8"	24' 1"	7' 3-3/8"	5' 8-3/4"	42"				
LSWE 8P-6N24	28,980	11,400	42,250	(2) 40	115,300	(2) 5	1140	772	720	(2) 10"	39,110	13' 1/8"	24' 1"	7' 3-3/8"	5' 8-3/4"	42"				
LSWE 8P-6O24	29,020	11,420	42,290	(2) 50	124,200	(2) 5	1140	772	720	(2) 10"	39,150	13' 1/8"	24' 1"	7' 3-3/8"	5' 8-3/4"	42"				
LSWE 8P-7M24	31,300	12,560	45,610	(2) 30	102,600	(2) 5	1140	897	720	(2) 10"	42,470	13' 2-1/8"	24' 1"	7' 3-3/8"	5' 10-3/4"	47-3/4"				
LSWE 8P-7N24	31,940	12,880	46,250	(2) 40	112,900	(2) 5	1140	897	720	(2) 10"	43,110	13' 2-1/8"	24' 1"	7' 3-3/8"	5' 10-3/4"	47-3/4"				
LSWE 8P-7O24	31,980	12,900	46,290	(2) 50	121,600	(2) 5	1140	897	720	(2) 10"	43,150	13' 2-1/8"	24' 1"	7' 3-3/8"	5' 10-3/4"	47-3/4"				

† Model Number will end in "-Z" for units with Series Flow piping configuration. Series Flow units may require additional coil connections and will require crossover piping. Model numbers will include "I" for units with Intake Attenuation, "D" for units with Discharge Attenuation, "F" for units with Full Sound Attenuation, "T" for units with a Tapered Discharge Hood, and "S" for units with an option that negates CT1 Certification.
 †† Model normally ships in one piece.
 * Heaviest section is the coil section.
 ** Gallons shown is water in suspension in unit and piping. Allow for additional water in bottom of remote sump to cover pump suction and strainer during operation (12" would normally be sufficient).
 Δ When a remote sump arrangement is selected, the spray pump, suction strainer and associated piping are omitted; the unit is provided with an oversized outlet to facilitate drainage to the remote sump.
 ▲ Unit dimensions and coil connections may vary slightly from catalog. See factory certified prints for dimensions, quantity of coil connections, and piping configuration. Coil connections are 4" bevel for weld (BFW), also available as options. Other connection types such as grooved for mechanical coupling or flanged are also available as options.

LSWE 8P-3M36 to 8P-7P36

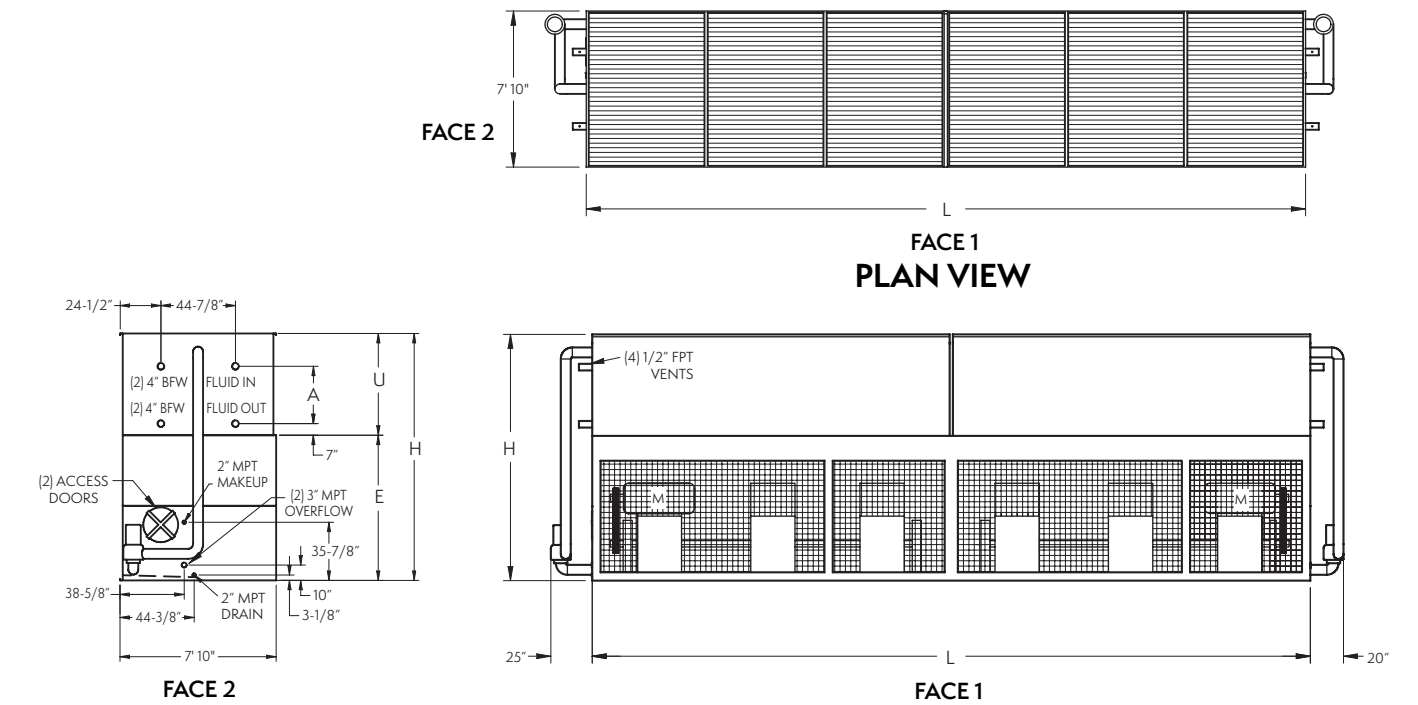

NOTE: The number of coil connections doubles when the flow rate exceeds 1800 gpm on 8Px36 models. This required option is referred to as the High Flow coil configuration.

Model No. †	WEIGHTS (LBS)			FANS		SPRAY PUMP		COIL			REMOTE SUMP Δ			DIMENSIONS ▲				
	Shipping	Heaviest Section*	Operating	HP	CFM	HP	GPM	Volume (Gallons)	Gallons Req'd**	Conn. Size	Operating Weight (lbs)	Height H	Length L	Lower E	Upper U	Coil A		
LSWE 8P-3M36	28,010	9,580	43,310	(2) 30	145,600	(2) 7.5	1680	590	1060	(2) 12"	37,640	11' 1-5/8"	36' 1-1/2"	7' 3-3/8"	3' 10-1/4"	19-1/2"		
LSWE 8P-3N36	28,650	9,900	43,950	(2) 40	160,200	(2) 7.5	1680	590	1060	(2) 12"	38,280	11' 1-5/8"	36' 1-1/2"	7' 3-3/8"	3' 10-1/4"	19-1/2"		
LSWE 8P-3O36	28,690	9,920	43,990	(2) 50	172,600	(2) 7.5	1680	590	1060	(2) 12"	38,320	11' 1-5/8"	36' 1-1/2"	7' 3-3/8"	3' 10-1/4"	19-1/2"		
LSWE 8P-3P36	29,490	10,320††	44,790	(2) 60	183,400	(2) 7.5	1680	590	1060	(2) 12"	39,120	11' 1-5/8"	36' 1-1/2"	7' 3-3/8"	3' 10-1/4"	19-1/2"		
LSWE 8P-4M36	32,410	11,780	49,270	(2) 30	142,700	(2) 7.5	1680	778	1060	(2) 12"	43,940	11' 9-1/8"	36' 1-1/2"	7' 3-3/8"	4' 5-3/4"	27"		
LSWE 8P-4N36	33,050	12,100	49,910	(2) 40	157,100	(2) 7.5	1680	778	1060	(2) 12"	44,580	11' 9-1/8"	36' 1-1/2"	7' 3-3/8"	4' 5-3/4"	27"		
LSWE 8P-4O36	33,090	12,120	49,950	(2) 50	169,200	(2) 7.5	1680	778	1060	(2) 12"	44,620	11' 9-1/8"	36' 1-1/2"	7' 3-3/8"	4' 5-3/4"	27"		
LSWE 8P-4P36	33,890	12,520	50,750	(2) 60	179,800	(2) 7.5	1680	778	1060	(2) 12"	45,420	11' 9-1/8"	36' 1-1/2"	7' 3-3/8"	4' 5-3/4"	27"		
LSWE 8P-5N36	37,250	14,200	55,670	(2) 40	153,900	(2) 7.5	1680	966	1060	(2) 12"	50,710	12' 4-5/8"	36' 1-1/2"	7' 3-3/8"	5' 1-1/4"	34-1/2"		
LSWE 8P-5O36	37,290	14,220	55,710	(2) 50	165,800	(2) 7.5	1680	966	1060	(2) 12"	50,750	12' 4-5/8"	36' 1-1/2"	7' 3-3/8"	5' 1-1/4"	34-1/2"		
LSWE 8P-5P36	38,090	14,620	56,510	(2) 60	176,200	(2) 7.5	1680	966	1060	(2) 12"	51,550	12' 4-5/8"	36' 1-1/2"	7' 3-3/8"	5' 1-1/4"	34-1/2"		
LSWE 8P-6N36	41,650	16,400	61,650	(2) 40	150,800	(2) 7.5	1680	1153	1060	(2) 12"	57,010	13' 1/8"	36' 1-1/2"	7' 3-3/8"	5' 8-3/4"	42"		
LSWE 8P-6O36	41,690	16,420	61,690	(2) 50	162,400	(2) 7.5	1680	1153	1060	(2) 12"	57,050	13' 1/8"	36' 1-1/2"	7' 3-3/8"	5' 8-3/4"	42"		
LSWE 8P-6P36	42,490	16,820	62,490	(2) 60	172,600	(2) 7.5	1680	1153	1060	(2) 12"	57,850	13' 1/8"	36' 1-1/2"	7' 3-3/8"	5' 8-3/4"	42"		
LSWE 8P-7N36	46,030	18,590	67,590	(2) 40	147,600	(2) 7.5	1680	1341	1060	(2) 12"	62,960	13' 2-1/8"	36' 1-1/2"	7' 3-3/8"	5' 10-3/4"	47-3/4"		
LSWE 8P-7O36	46,070	18,610	67,630	(2) 50	159,000	(2) 7.5	1680	1341	1060	(2) 12"	63,000	13' 2-1/8"	36' 1-1/2"	7' 3-3/8"	5' 10-3/4"	47-3/4"		
LSWE 8P-7P36	46,870	19,010	68,430	(2) 60	169,000	(2) 7.5	1680	1341	1060	(2) 12"	63,800	13' 2-1/8"	36' 1-1/2"	7' 3-3/8"	5' 10-3/4"	47-3/4"		

† Model Number will end in "-Z" for units with Series Flow piping configuration. Series Flow units may require additional coil connections and will require crossover piping. Model numbers will include "I" for units with Intake Attenuation, "D" for units with Discharge Attenuation, "F" for units with Full Sound Attenuation, "T" for units with a Tapered Discharge Hood, and "S" for units with an option that negates CT1 Certification.
 †† Model normally ships in one piece.
 * Heaviest section is the coil section.
 ** Gallons shown is water in suspension in unit and piping. Allow for additional water in bottom of remote sump to cover pump suction and strainer during operation (12" would normally be sufficient).
 Δ When a remote sump arrangement is selected, the spray pump, suction strainer and associated piping are omitted; the unit is provided with an oversized outlet to facilitate drainage to the remote sump.
 ▲ Unit dimensions and coil connections may vary slightly from catalog. See factory certified prints for dimensions, quantity of coil connections, and piping configuration. Coil connections are 4" bevel for weld (BFW), also available as options. Other connection types such as grooved for mechanical coupling or flanged are also available as options.

LSWE 10-3M12 to 10-7P12

LSWE 10-3K18 to 10-7N18

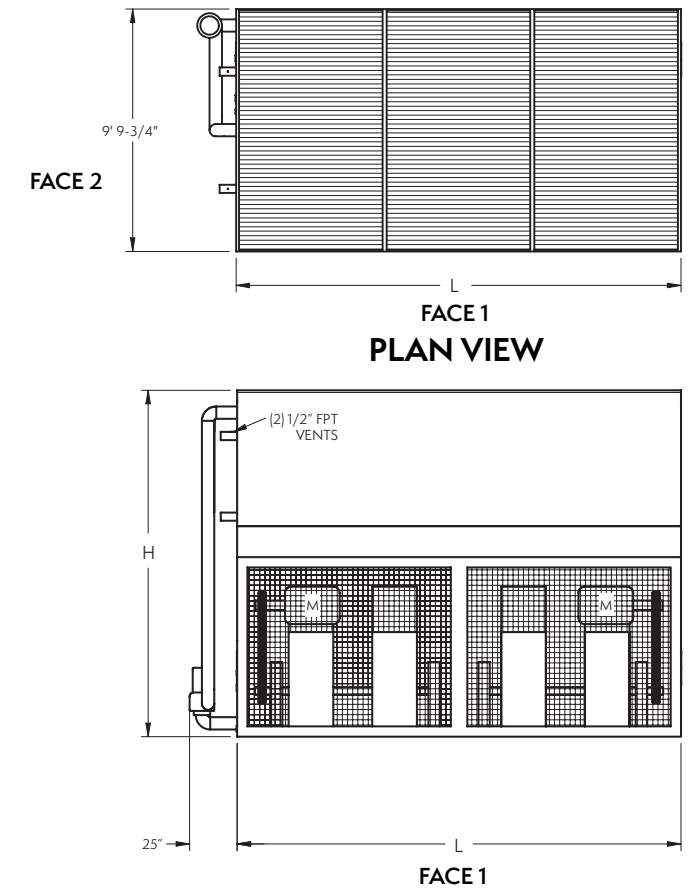
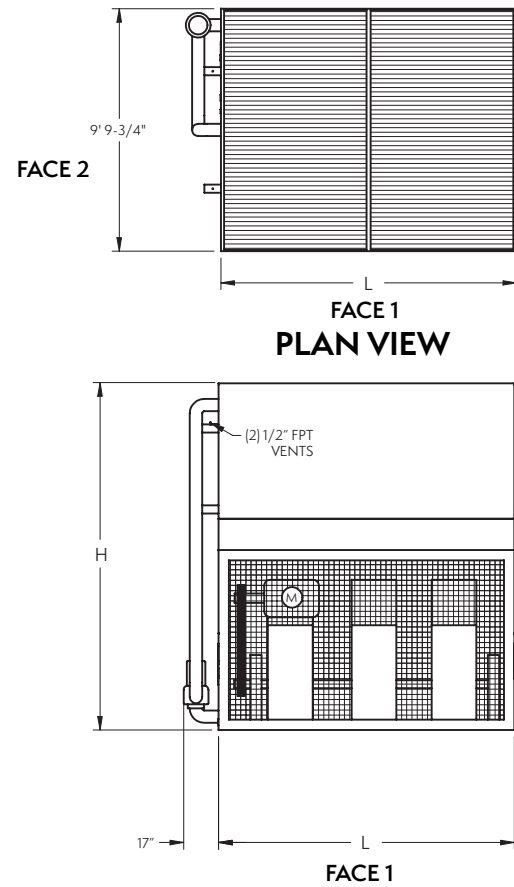

NOTE: The number of coil connections doubles when the flow rate exceeds 900 gpm on 10x12 models. This required option is referred to as the High Flow coil configuration.

Model No. †	WEIGHTS (LBS)			FANS		SPRAY PUMP		Coil Volume (Gallons)	REMOTE SUMP Δ					DIMENSIONS ▲				
	Shipping	Heaviest Section*	Operating	HP	CFM	HP	GPM		Gallons Req'd**	Conn. Size	Operating Weight (lbs)	Height H	Length L	Lower E	Upper U	Coil A		
LSWE 10-3M12	12,770	8,320	19,240	30	68,400	5	685	253	410	10"	16,990	12' 7-5/8"	11' 11-3/4"	8' 6-1/2"	4' 1-1/8"	22-1/4"		
LSWE 10-3N12	12,930	8,480	19,400	40	75,200	5	685	253	410	10"	17,150	12' 7-5/8"	11' 11-3/4"	8' 6-1/2"	4' 1-1/8"	22-1/4"		
LSWE 10-3O12	12,940	8,490	19,410	50	81,100	5	685	253	410	10"	17,160	12' 7-5/8"	11' 11-3/4"	8' 6-1/2"	4' 1-1/8"	22-1/4"		
LSWE 10-4M12	14,690	10,240	21,820	30	67,000	5	685	332	410	10"	19,750	13' 4-1/8"	11' 11-3/4"	8' 6-1/2"	4' 9-5/8"	30-3/4"		
LSWE 10-4N12	14,850	10,400	21,980	40	73,800	5	685	332	410	10"	19,910	13' 4-1/8"	11' 11-3/4"	8' 6-1/2"	4' 9-5/8"	30-3/4"		
LSWE 10-4O12	14,860	10,410	21,990	50	79,500	5	685	332	410	10"	19,920	13' 4-1/8"	11' 11-3/4"	8' 6-1/2"	4' 9-5/8"	30-3/4"		
LSWE 10-5M12	16,500	12,050	24,290	30	65,700	5	685	411	410	10"	22,390	14' 5/8"	11' 11-3/4"	8' 6-1/2"	5' 6-1/8"	39-1/4"		
LSWE 10-5N12	16,660	12,210	24,450	40	72,300	5	685	411	410	10"	22,550	14' 5/8"	11' 11-3/4"	8' 6-1/2"	5' 6-1/8"	39-1/4"		
LSWE 10-5O12	16,670	12,220	24,460	50	77,900	5	685	411	410	10"	22,560	14' 5/8"	11' 11-3/4"	8' 6-1/2"	5' 6-1/8"	39-1/4"		
LSWE 10-6M12	18,400	13,950	26,840	30	64,300	5	685	490	410	10"	25,120	14' 9-1/8"	11' 11-3/4"	8' 6-1/2"	6' 2-5/8"	47-3/4"		
LSWE 10-6N12	18,560	14,110	27,000	40	70,800	5	685	490	410	10"	25,280	14' 9-1/8"	11' 11-3/4"	8' 6-1/2"	6' 2-5/8"	47-3/4"		
LSWE 10-6O12	18,570	14,120	27,010	50	76,300	5	685	490	410	10"	25,290	14' 9-1/8"	11' 11-3/4"	8' 6-1/2"	6' 2-5/8"	47-3/4"		
LSWE 10-6P12	18,770	14,320	27,210	60	81,100	5	685	490	410	10"	25,490	14' 9-1/8"	11' 11-3/4"	8' 6-1/2"	6' 2-5/8"	47-3/4"		
LSWE 10-7M12	20,640	16,190	29,740	30	63,000	5	685	569	410	10"	28,020	14' 9-1/8"	11' 11-3/4"	8' 6-1/2"	6' 2-5/8"	47-3/4"		
LSWE 10-7N12	20,800	16,350	29,900	40	69,300	5	685	569	410	10"	28,180	14' 9-1/8"	11' 11-3/4"	8' 6-1/2"	6' 2-5/8"	47-3/4"		
LSWE 10-7O12	20,810	16,360	29,910	50	74,700	5	685	569	410	10"	28,190	14' 9-1/8"	11' 11-3/4"	8' 6-1/2"	6' 2-5/8"	47-3/4"		
LSWE 10-7P12	21,010	16,560	30,110	60	79,400	5	685	569	410	10"	28,390	14' 9-1/8"	11' 11-3/4"	8' 6-1/2"	6' 2-5/8"	47-3/4"		

† Model Number will end in "-Z" for units with Series Flow piping configuration. Series Flow units may require additional coil connections and will require crossover piping. Model numbers will include "I" for units with Intake Attenuation, "D" for units with Discharge Attenuation, "F" for units with Full Sound Attenuation, "T" for units with a Tapered Discharge Hood, and "S" for units with an option that negates CTI Certification.

* Heaviest section is the coil section.

** Gallons shown is water in suspension in unit and piping. Allow for additional water in bottom of remote sump to cover pump suction and strainer during operation (12" would normally be sufficient).

Δ When a remote sump arrangement is selected, the spray pump, suction strainer and associated piping are omitted; the unit is provided with an oversized outlet to facilitate drainage to the remote sump.

▲ Unit dimensions and coil connections may vary slightly from catalog. See factory certified prints for dimensions, quantity of coil connections, and piping configuration. Coil connections are 4" bevel for weld (BFW), also available as options. Other connection types such as grooved for mechanical coupling or flanged are also available as options.

NOTE: The number of coil connections doubles when the flow rate exceeds 900 gpm on 10x18 models. This required option is referred to as the High Flow coil configuration.

Model No. †	WEIGHTS (LBS)			FANS		SPRAY PUMP		Coil Volume (Gallons)	REMOTE SUMP Δ					DIMENSIONS ▲				
	Shipping	Heaviest Section*	Operating	HP	CFM	HP	GPM		Gallons Req'd**	Conn. Size	Operating Weight (lbs)	Height H	Length L	Lower E	Upper U	Coil A		
LSWE 10-3K18	18,660	12,250	28,410	(2) 20	98,800	7.5	1,030	374	600	12"	24,900	12' 7-5/8"	18' 1/4"	8' 6-1/2"	4' 1-1/8"	22-1/4"		
LSWE 10-3L18	18,720	12,310	28,470	(2) 25	106,400	7.5	1,030	374	600	12"	24,960	12' 7-5/8"	18' 1/4"	8' 6-1/2"	4' 1-1/8"	22-1/4"		
LSWE 10-3M18	18,820	12,410	28,570	(2) 30	113,100	7.5	1,030	374	600	12"	25,060	12' 7-5/8"	18' 1/4"	8' 6-1/2"	4' 1-1/8"	22-1/4"		
LSWE 10-3N18	19,140	12,730	28,890	(2) 40	124,500	7.5	1,030	374	600	12"	25,380	12' 7-5/8"	18' 1/4"	8' 6-1/2"	4' 1-1/8"	22-1/4"		
LSWE 10-4L18	21,530	15,120	32,270	(2) 25	104,400	7.5	1,030	494	600	12"	28,980	13' 4-1/8"	18' 1/4"	8' 6-1/2"	4' 9-5/8"	30-3/4"		
LSWE 10-4M18	21,630	15,220	32,370	(2) 30	110,900	7.5	1,030	494	600	12"	29,080	13' 4-1/8"	18' 1/4"	8' 6-1/2"	4' 9-5/8"	30-3/4"		
LSWE 10-4N18	21,950	15,540	32,690	(2) 40	122,000	7.5	1,030	494	600	12"	29,400	13' 4-1/8"	18' 1/4"	8' 6-1/2"	4' 9-5/8"	30-3/4"		
LSWE 10-5L18	24,240	17,830	35,980	(2) 25	102,300	7.5	1,030	613	600	12"	32,950	14' 5/8"	18' 1/4"	8' 6-1/2"	5' 6-1/8"	39-1/4"		
LSWE 10-5M18	24,340	17,930	36,080	(2) 30	108,700	7.5	1,030	613	600	12"	33,050	14' 5/8"	18' 1/4"	8' 6-1/2"	5' 6-1/8"	39-1/4"		
LSWE 10-5N18	24,660	18,250	36,400	(2) 40	119,600	7.5	1,030	613	600	12"	33,370	14' 5/8"	18' 1/4"	8' 6-1/2"	5' 6-1/8"	39-1/4"		
LSWE 10-6L18	27,060	20,650	39,790	(2) 25	100,200	7.5	1,030	732	600	12"	37,010	14' 9-1/8"	18' 1/4"	8' 6-1/2"	6' 2-5/8"	47-3/4"		
LSWE 10-6M18	27,160	20,750	39,890	(2) 30	106,500	7.5	1,030	732	600	12"	37,110	14' 9-1/8"	18' 1/4"	8' 6-1/2"	6' 2-5/8"	47-3/4"		
LSWE 10-6N18	27,480	21,070	40,210	(2) 40	117,200	7.5	1,030	732	600	12"	37,430	14' 9-1/8"	18' 1/4"	8' 6-1/2"	6' 2-5/8"	47-3/4"		
LSWE 10-7L18	30,420	24,010	44,150	(2) 25	98,100	7.5	1,030	851	600	12"	41,370	14' 9-1/8"	18' 1/4"	8' 6-1/2"	6' 2-5/8"	47-3/4"		
LSWE 10-7M18	30,520	24,110	44,250	(2) 30	104,200	7.5	1,030	851	600	12"	41,470	14' 9-1/8"	18' 1/4"	8' 6-1/2"	6' 2-5/8"	47-3/4"		
LSWE 10-7N18	30,840	24,430	44,570	(2) 40	114,700	7.5	1,030	851	600	12"	41,790	14' 9-1/8"	18' 1/4"	8' 6-1/2"	6' 2-5/8"	47-3/4"		

† Model Number will end in "-Z" for units with Series Flow piping configuration. Series Flow units may require additional coil connections and will require crossover piping. Model numbers will include "I" for units with Intake Attenuation, "D" for units with Discharge Attenuation, "F" for units with Full Sound Attenuation, "T" for units with a Tapered Discharge Hood, and "S" for units with an option that negates CTI Certification.

* Heaviest section is the coil section.

** Gallons shown is water in suspension in unit and piping. Allow for additional water in bottom of remote sump to cover pump suction and strainer during operation (12" would normally be sufficient).

Δ When a remote sump arrangement is selected, the spray pump, suction strainer and associated piping are omitted; the unit is provided with an oversized outlet to facilitate drainage to the remote sump.

▲ Unit dimensions and coil connections may vary slightly from catalog. See factory certified prints for dimensions, quantity of coil connections, and piping configuration. Coil connections are 4" bevel for weld (BFW), also available as options. Other connection types such as grooved for mechanical coupling or flanged are also available as options.

LSWE 10-3M24 to 10-7P24

LSWE 10-3K36 to 10-7N36

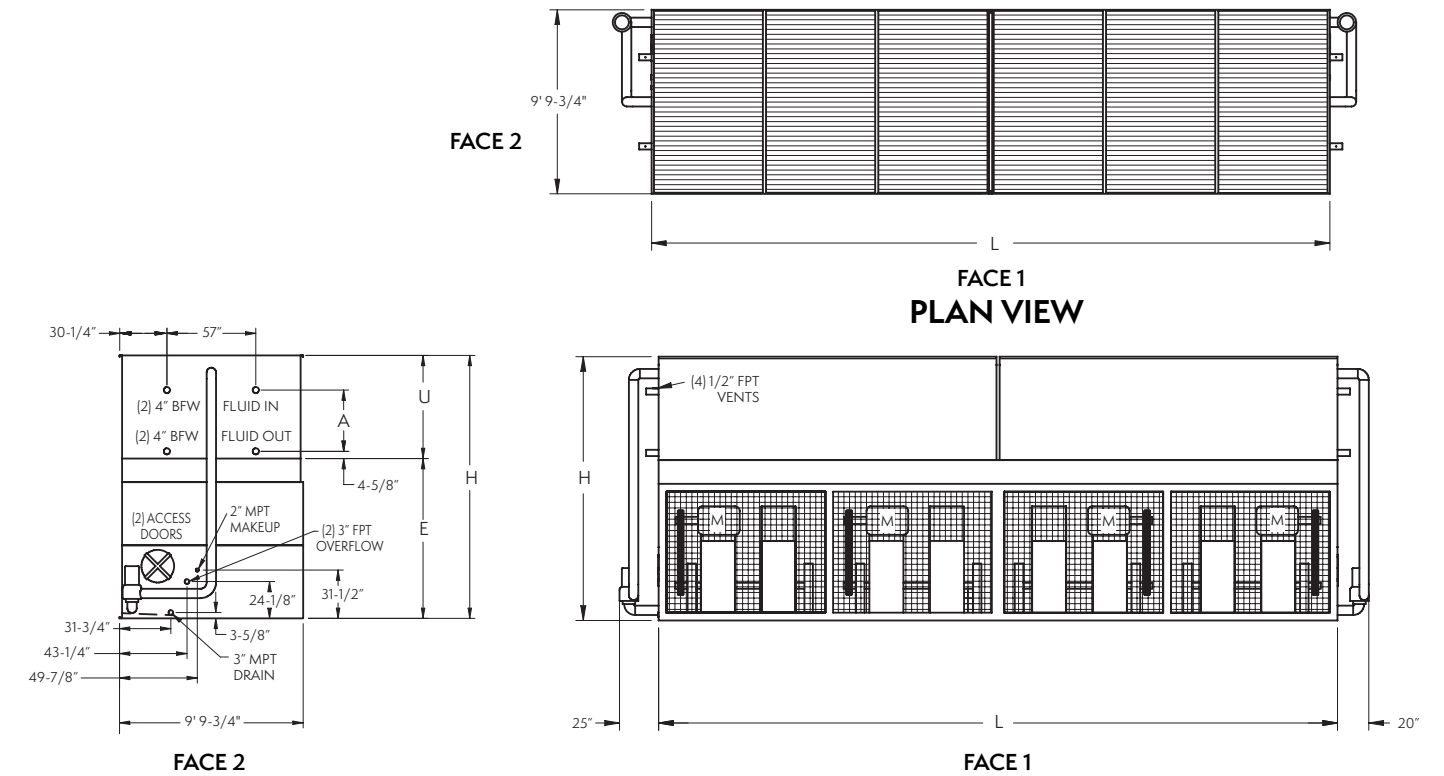
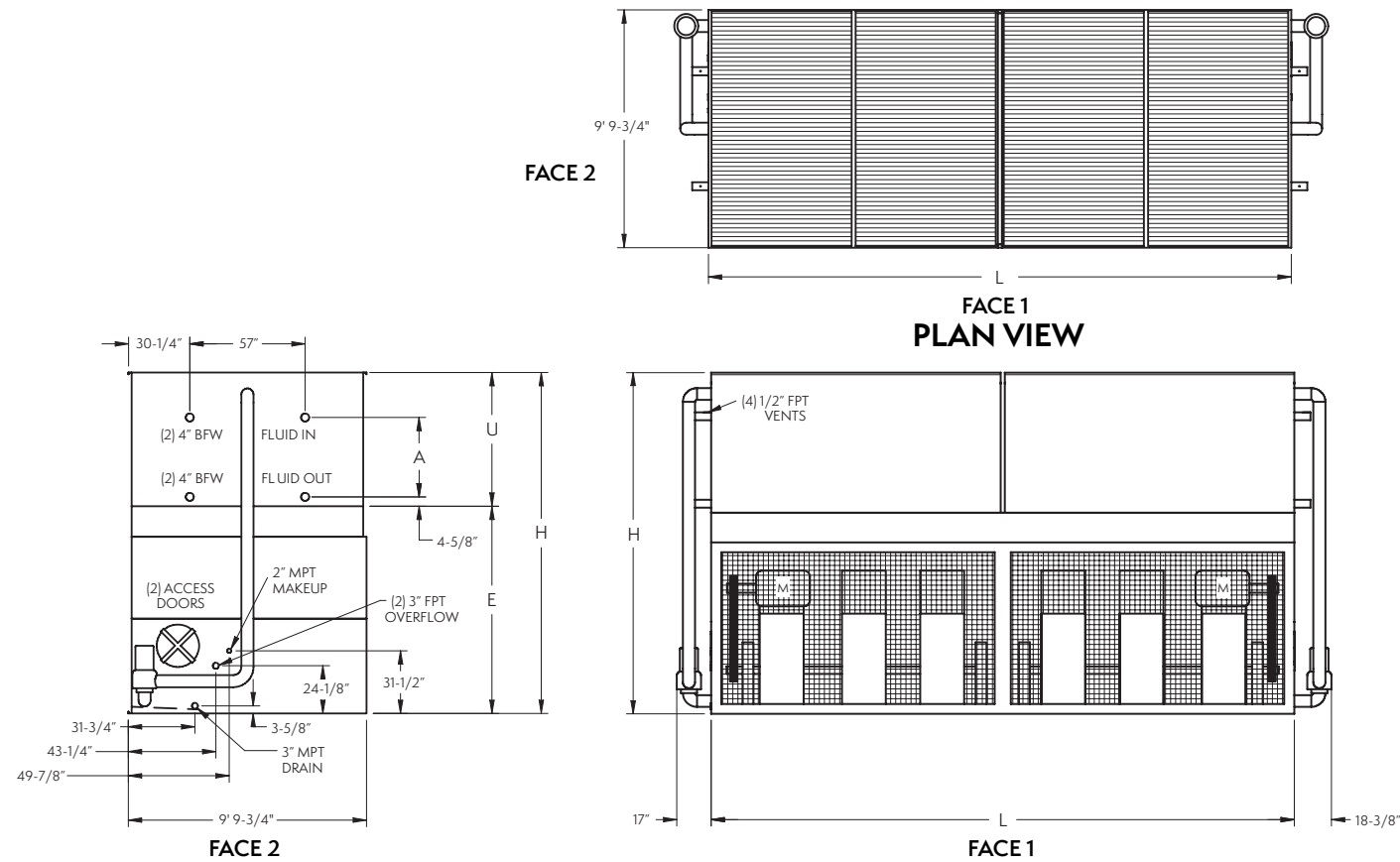

NOTE: The number of coil connections doubles when the flow rate exceeds 1800 gpm on 10x24 models. This required option is referred to as the High Flow coil configuration.

NOTE: The number of coil connections doubles when the flow rate exceeds 1800 gpm on 10x36 models. This required option is referred to as the High Flow coil configuration.

Model No. †	WEIGHTS (LBS)			FANS		SPRAY PUMP		Coil		REMOTE SUMP Δ					DIMENSIONS ▲				
	Shipping	Heaviest Section	Operating	HP	CFM	HP	GPM	Volume (Gallons)	Gallons Req'd**	Conn. Size	Operating Weight (lbs)	Height H	Length L	Lower E	Upper U	Coil A			
LSWE 10-3M24	25,840	8,760	38,940	[2] 30	136,700	[2] 5	1,370	507	820	[2] 10"	34,130	12' 7-5/8"	24' 3/4"	8' 6-1/2"	4' 1-1/8"	22-1/4"			
LSWE 10-3N24	26,480	9,080	39,580	[2] 40	150,500	[2] 5	1,370	507	820	[2] 10"	34,770	12' 7-5/8"	24' 3/4"	8' 6-1/2"	4' 1-1/8"	22-1/4"			
LSWE 10-3O24	26,520	9,100	39,620	[2] 50	162,100	[2] 5	1,370	507	820	[2] 10"	34,810	12' 7-5/8"	24' 3/4"	8' 6-1/2"	4' 1-1/8"	22-1/4"			
LSWE 10-4M24	29,660	10,670	44,080	[2] 30	134,000	[2] 5	1,370	664	820	[2] 10"	39,600	13' 4-1/8"	24' 3/4"	8' 6-1/2"	4' 9-5/8"	30-3/4"			
LSWE 10-4N24	30,300	10,990	44,720	[2] 40	147,500	[2] 5	1,370	664	820	[2] 10"	40,240	13' 4-1/8"	24' 3/4"	8' 6-1/2"	4' 9-5/8"	30-3/4"			
LSWE 10-4O24	30,340	11,010	44,760	[2] 50	158,900	[2] 5	1,370	664	820	[2] 10"	40,280	13' 4-1/8"	24' 3/4"	8' 6-1/2"	4' 9-5/8"	30-3/4"			
LSWE 10-5M24	33,300	12,490	49,040	[2] 30	131,400	[2] 5	1,370	822	820	[2] 10"	44,880	14' 5/8"	24' 3/4"	8' 6-1/2"	5' 6-1/8"	39-1/4"			
LSWE 10-5N24	33,940	12,810	49,680	[2] 40	144,600	[2] 5	1,370	822	820	[2] 10"	45,520	14' 5/8"	24' 3/4"	8' 6-1/2"	5' 6-1/8"	39-1/4"			
LSWE 10-5O24	33,980	12,830	49,720	[2] 50	155,800	[2] 5	1,370	822	820	[2] 10"	45,560	14' 5/8"	24' 3/4"	8' 6-1/2"	5' 6-1/8"	39-1/4"			
LSWE 10-6M24	37,100	14,390	54,140	[2] 30	128,700	[2] 5	1,370	980	820	[2] 10"	50,310	14' 9-1/8"	24' 3/4"	8' 6-1/2"	6' 2-5/8"	47-3/4"			
LSWE 10-6N24	37,740	14,710	54,780	[2] 40	141,600	[2] 5	1,370	980	820	[2] 10"	50,950	14' 9-1/8"	24' 3/4"	8' 6-1/2"	6' 2-5/8"	47-3/4"			
LSWE 10-6O24	37,780	14,730	54,820	[2] 50	152,600	[2] 5	1,370	980	820	[2] 10"	50,990	14' 9-1/8"	24' 3/4"	8' 6-1/2"	6' 2-5/8"	47-3/4"			
LSWE 10-6P24	38,580	15,130	55,620	[2] 60	162,100	[2] 5	1,370	980	820	[2] 10"	51,790	14' 9-1/8"	24' 3/4"	8' 6-1/2"	6' 2-5/8"	47-3/4"			
LSWE 10-7M24	41,580	16,630	59,940	[2] 30	126,000	[2] 5	1,370	1,138	820	[2] 10"	56,110	14' 9-1/8"	24' 3/4"	8' 6-1/2"	6' 2-5/8"	47-3/4"			
LSWE 10-7N24	42,220	16,950	60,580	[2] 40	138,700	[2] 5	1,370	1,138	820	[2] 10"	56,750	14' 9-1/8"	24' 3/4"	8' 6-1/2"	6' 2-5/8"	47-3/4"			
LSWE 10-7O24	42,260	16,970	60,620	[2] 50	149,400	[2] 5	1,370	1,138	820	[2] 10"	56,790	14' 9-1/8"	24' 3/4"	8' 6-1/2"	6' 2-5/8"	47-3/4"			
LSWE 10-7P24	43,060	17,370	61,420	[2] 60	158,800	[2] 5	1,370	1,138	820	[2] 10"	57,590	14' 9-1/8"	24' 3/4"	8' 6-1/2"	6' 2-5/8"	47-3/4"			

Model No. †	WEIGHTS (LBS)			FANS		SPRAY PUMP		Coil		REMOTE SUMP Δ					DIMENSIONS ▲				
	Shipping	Heaviest Section	Operating	HP	CFM	HP	GPM	Volume (Gallons)	Gallons Req'd**	Conn. Size	Operating Weight (lbs)	Height H	Length L	Lower E	Upper U	Coil A			
LSWE 10-3K36	38,700	12,700††	58,210	[4] 20	197,600	[2] 7.5	2,060	748	1,500	[2] 12"	51,310	12' 7-5/8"	36' 2"	8' 6-1/2"	4' 1-1/8"	22-1/4"			
LSWE 10-3L36	38,940	13,090††	58,450	[4] 25	212,900	[2] 7.5	2,060	748	1,500	[2] 12"	51,550	12' 7-5/8"	36' 2"	8' 6-1/2"	4' 1-1/8"	22-1/4"			
LSWE 10-3M36	39,340	13,290††	58,850	[4] 30	226,200	[2] 7.5	2,060	748	1,500	[2] 12"	51,950	12' 7-5/8"	36' 2"	8' 6-1/2"	4' 1-1/8"	22-1/4"			
LSWE 10-3N36	40,620	13,930††	60,130	[4] 40	249,000	[2] 7.5	2,060	748	1,500	[2] 12"	53,230	12' 7-5/8"	36' 2"	8' 6-1/2"	4' 1-1/8"	22-1/4"			
LSWE 10-4L36	44,560	15,900††	66,050	[4] 25	208,700	[2] 7.5	2,060	987	1,500	[2] 12"	59,580	13' 4-1/8"	36' 2"	8' 6-1/2"	4' 9-5/8"	30-3/4"			
LSWE 10-4M36	44,960	16,100††	66,450	[4] 30	221,800	[2] 7.5	2,060	987	1,500	[2] 12"	59,980	13' 4-1/8"	36' 2"	8' 6-1/2"	4' 9-5/8"	30-3/4"			
LSWE 10-4N36	46,240	16,740††	67,730	[4] 40	244,100	[2] 7.5	2,060	987	1,500	[2] 12"	61,260	13' 4-1/8"	36' 2"	8' 6-1/2"	4' 9-5/8"	30-3/4"			
LSWE 10-5L36	49,980	18,610	73,470	[4] 25	204,500	[2] 7.5	2,060	1,226	1,500	[2] 12"	67,520	14' 5/8"	36' 2"	8' 6-1/2"	5' 6-1/8"	39-1/4"			
LSWE 10-5M36	50,380	18,810	73,870	[4] 30	217,300	[2] 7.5	2,060	1,226	1,500	[2] 12"	67,920	14' 5/8"	36' 2"	8' 6-1/2"	5' 6-1/8"	39-1/4"			
LSWE 10-5N36	51,660	19,450	75,150	[4] 40	239,200	[2] 7.5	2,060	1,226	1,500	[2] 12"	69,200	14' 5/8"	36' 2"	8' 6-1/2"	5' 6-1/8"	39-1/4"			
LSWE 10-6L36	55,600	21,420	81,070	[4] 25	200,400	[2] 7.5	2,060	1,464	1,500	[2] 12"	75,640	14' 9-1/8"	36' 2"	8' 6-1/2"	6' 2-5/8"	47-3/4"			
LSWE 10-6M36	56,000	21,620	81,470	[4] 30	212,900	[2] 7.5	2,060	1,464	1,500	[2] 12"	76,040	14' 9-1/8"	36' 2"	8' 6-1/2"	6' 2-5/8"	47-3/4"			
LSWE 10-6N36	57,280	22,260	82,750	[4] 40	234,300	[2] 7.5	2,060	1,464	1,500	[2] 12"	77,320	14' 9-1/8"	36' 2"	8' 6-1/2"	6' 2-5/8"	47-3/4"			
LSWE 10-7L36	62,320	24,780	89,790	[4] 25	196,200	[2] 7.5	2,060	1,703	1,500	[2] 12"	84,360	14' 9-1/8"	36' 2"	8' 6-1/2"	6' 2-5/8"	47-3/4"			
LSWE 10-7M36	62,720	24,980	90,190	[4] 30	208,500	[2] 7.5	2,060	1,703	1,500	[2] 12"	84,760	14' 9-1/8"	36' 2"	8' 6-1/2"	6' 2-5/8"	47-3/4"			
LSWE 10-7N36	64,000	25,620	91,470	[4] 40	229,500	[2] 7.5	2,060	1,703	1,500	[2] 12"	86,040	14' 9-1/8"	36' 2"	8' 6-1/2"	6' 2-5/8"	47-3/4"			

† Model Number will end in "-Z" for units with Series Flow piping configuration. Series Flow units may require additional coil connections and will require crossover piping. Model numbers will include "I" for units with Intake Attenuation, "D" for units with Discharge Attenuation, "F" for units with Full Sound Attenuation, "T" for units with a Tapered Discharge Hood, and "S" for units with an option that negates CTI Certification.

† Model Number will end in "-Z" for units with Series Flow piping configuration. Series Flow units may require additional coil connections and will require crossover piping. Model numbers will include "I" for units with Intake Attenuation, "D" for units with Discharge Attenuation, "F" for units with Full Sound Attenuation, "T" for units with a Tapered Discharge Hood, and "S" for units with an option that negates CTI Certification.

* Heaviest section is the coil section.

†† Heaviest section is the fan section.

** Gallons shown is water in suspension in unit and piping. Allow for additional water in bottom of remote sump to cover pump suction and strainer during operation (12" would normally be sufficient).

** Gallons shown is water in suspension in unit and piping. Allow for additional water in bottom of remote sump to cover pump suction and strainer during operation (12" would normally be sufficient).

Δ When a remote sump arrangement is selected, the spray pump, suction strainer and associated piping are omitted; the unit is provided with an oversized outlet to facilitate drainage to the remote sump.

Δ When a remote sump arrangement is selected, the spray pump, suction strainer and associated piping are omitted; the unit is provided with an oversized outlet to facilitate drainage to the remote sump.

▲ Unit dimensions and coil connections may vary slightly from catalog. See factory certified prints for dimensions, quantity of coil connections, and piping configuration. Coil connections are 4" bevel for weld (BFW), also available as options. Other connection types such as grooved for mechanical coupling or flanged are also available as options.

▲ Unit dimensions and coil connections may vary slightly from catalog. See factory certified prints for dimensions, quantity of coil connections, and piping configuration. Coil connections are 4" bevel for weld (BFW), also available as options. Other connection types such as grooved for mechanical coupling or flanged are also available as options.

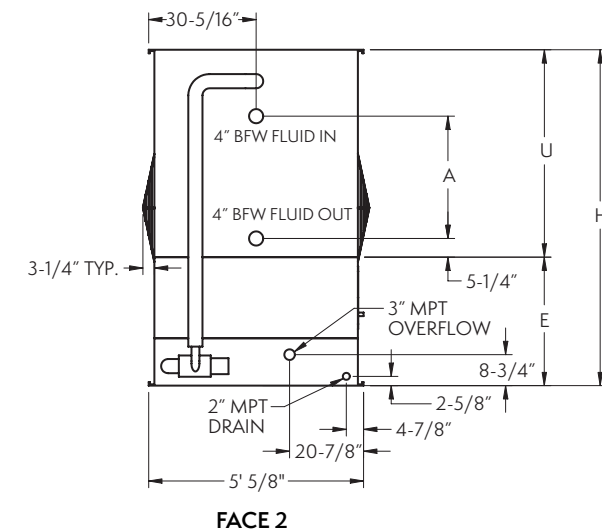
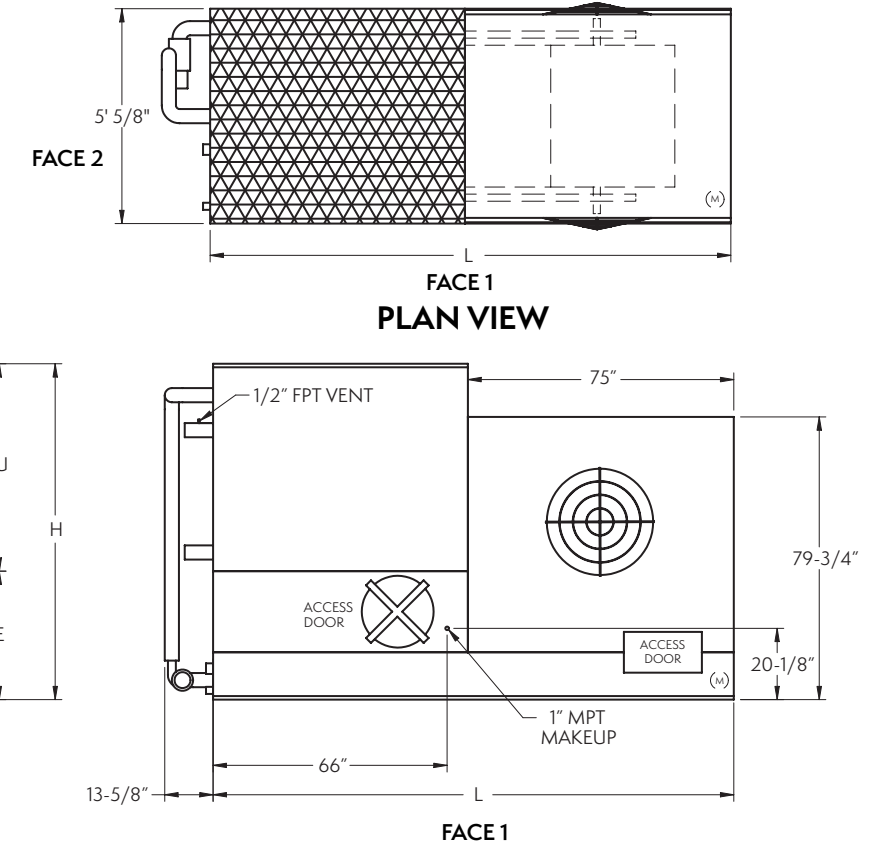
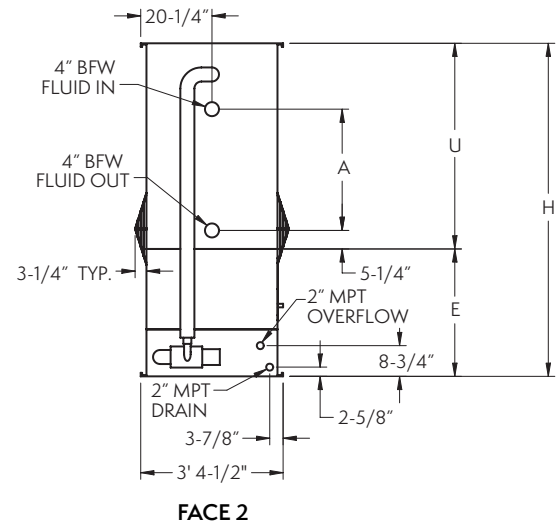
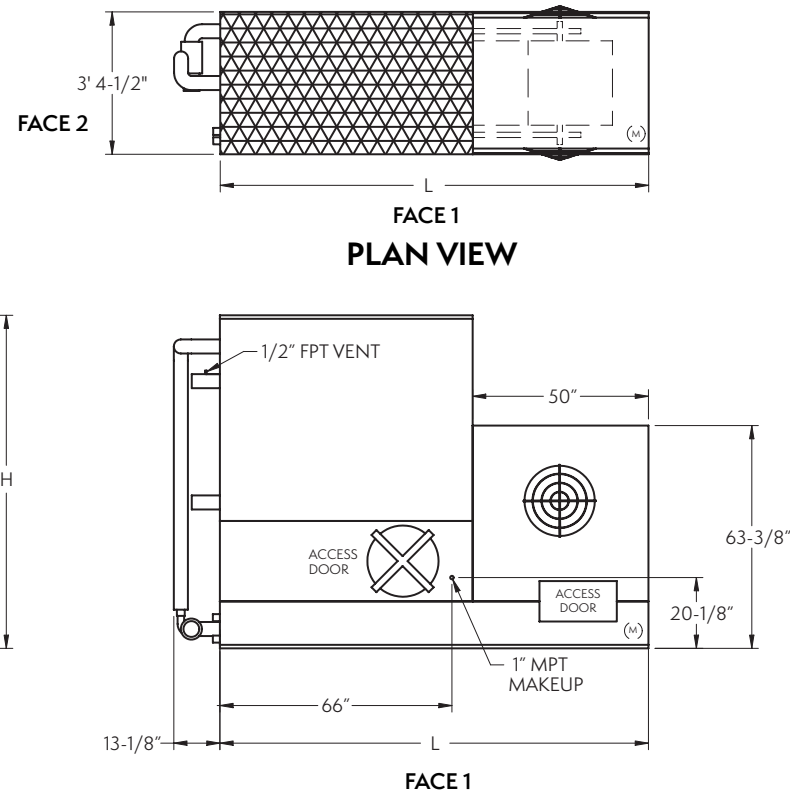

NOTE: The number of coil connections doubles when the flow rate exceeds 450 gpm on 3x6 models. This required option is referred to as the High Flow coil configuration.

Model No. †	WEIGHTS (LBS)		FANS		SPRAY PUMP		Coil Volume (Gallons)	REMOTE SUMP Δ			DIMENSIONS ▲				
	Shipping	Operating	HP	CFM	HP	GPM		Gallons Req'd**	Conn. Size	Operating Weight (lbs)	Height H	Length L	Lower E	Upper U	Coil A
LRWB 3-2D6	2,320	3,560	1.5	7,600	1/2	100	30	33	4"	2,700	6' 1/4"	10' 1-7/8"	3' 1/4"	3'	12"
LRWB 3-2E6	2,320	3,560	2	8,300	1/2	100	30	33	4"	2,700	6' 1/4"	10' 1-7/8"	3' 1/4"	3'	12"
LRWB 3-2F6	2,330	3,570	3	9,600	1/2	100	30	33	4"	2,720	6' 1/4"	10' 1-7/8"	3' 1/4"	3'	12"
LRWB 3-2G6	2,340	3,580	5	11,300	1/2	100	30	33	4"	2,730	6' 1/4"	10' 1-7/8"	3' 1/4"	3'	12"
LRWB 3-2H6	2,390	3,630	7.5	13,000	1/2	100	30	33	4"	2,770	6' 1/4"	10' 1-7/8"	3' 1/4"	3'	12"
LRWB 3-3E6	2,640	4,000	2	8,200	1/2	100	43	33	4"	3,140	6' 7-3/4"	10' 1-7/8"	3' 1/4"	3' 7-1/2"	19-1/2"
LRWB 3-3F6	2,660	4,020	3	9,400	1/2	100	43	33	4"	3,160	6' 7-3/4"	10' 1-7/8"	3' 1/4"	3' 7-1/2"	19-1/2"
LRWB 3-3G6	2,670	4,030	5	11,100	1/2	100	43	33	4"	3,170	6' 7-3/4"	10' 1-7/8"	3' 1/4"	3' 7-1/2"	19-1/2"
LRWB 3-3H6	2,710	4,070	7.5	12,700	1/2	100	43	33	4"	3,210	6' 7-3/4"	10' 1-7/8"	3' 1/4"	3' 7-1/2"	19-1/2"
LRWB 3-4E6	3,000	4,460	2	8,000	1/2	100	55	33	4"	3,600	7' 3-1/4"	10' 1-7/8"	3' 1/4"	4' 3"	27"
LRWB 3-4F6	3,010	4,470	3	9,200	1/2	100	55	33	4"	3,620	7' 3-1/4"	10' 1-7/8"	3' 1/4"	4' 3"	27"
LRWB 3-4G6	3,020	4,480	5	10,900	1/2	100	55	33	4"	3,630	7' 3-1/4"	10' 1-7/8"	3' 1/4"	4' 3"	27"
LRWB 3-4H6	3,060	4,520	7.5	12,500	1/2	100	55	33	4"	3,670	7' 3-1/4"	10' 1-7/8"	3' 1/4"	4' 3"	27"
LRWB 3-5F6	3,390	4,970	3	9,000	1/2	100	67	33	4"	4,120	7' 10-3/4"	10' 1-7/8"	3' 1/4"	4' 10-1/2"	34-1/2"
LRWB 3-5G6	3,400	4,980	5	10,700	1/2	100	67	33	4"	4,130	7' 10-3/4"	10' 1-7/8"	3' 1/4"	4' 10-1/2"	34-1/2"
LRWB 3-5H6	3,450	5,020	7.5	12,200	1/2	100	67	33	4"	4,170	7' 10-3/4"	10' 1-7/8"	3' 1/4"	4' 10-1/2"	34-1/2"
LRWB 3-5I6	3,490	5,070	10	13,500	1/2	100	67	33	4"	4,210	7' 10-3/4"	10' 1-7/8"	3' 1/4"	4' 10-1/2"	34-1/2"

† Model Number will end in "-Z" for units with Series Flow piping configuration. Series Flow units may require additional coil connections and will require crossover piping. Model numbers will include "I" for units with Intake Attenuation, "D" for units with Discharge Attenuation, "F" for units with Full Sound Attenuation, "T" for units with a Tapered Discharge Hood, and "S" for units with an option that negates CTI Certification.
 ** Gallons shown is water in suspension in unit and piping. Allow for additional water in bottom of remote sump to cover pump suction and strainer during operation (12" would normally be sufficient).
 Δ When a remote sump arrangement is selected, the spray pump, suction strainer and associated piping are omitted; the unit is provided with an oversized outlet to facilitate drainage to the remote sump.
 ▲ Unit dimensions and coil connections may vary slightly from catalog. See factory certified prints for dimensions, quantity of coil connections, and piping configuration. Coil connections are 4" bevel for weld (BFW), also available as options. Other connection types such as grooved for mechanical coupling or flanged are also available as options.

NOTE: The number of coil connections doubles when the flow rate exceeds 450 gpm on 5x6 models. This required option is referred to as the High Flow coil configuration.

Model No. †	WEIGHTS (LBS)		FANS		SPRAY PUMP		Coil Volume (Gallons)	REMOTE SUMP Δ			DIMENSIONS ▲				
	Shipping	Operating	HP	CFM	HP	GPM		Gallons Req'd**	Conn. Size	Operating Weight (lbs)	Height H	Length L	Lower E	Upper U	Coil A
LRWB 5-2F6	3,530	5,690	3	13,800	1	160	47	120	6"	4,210	6' 1/4"	12' 2-7/8"	3' 1/4"	3'	12"
LRWB 5-2G6	3,540	5,710	5	16,400	1	160	47	120	6"	4,230	6' 1/4"	12' 2-7/8"	3' 1/4"	3'	12"
LRWB 5-2H6	3,580	5,750	7.5	18,700	1	160	47	120	6"	4,270	6' 1/4"	12' 2-7/8"	3' 1/4"	3'	12"
LRWB 5-2I6	3,620	5,790	10	20,600	1	160	47	120	6"	4,310	6' 1/4"	12' 2-7/8"	3' 1/4"	3'	12"
LRWB 5-3F6	4,020	6,360	3	13,500	1	160	66	120	6"	4,880	6' 7-3/4"	12' 2-7/8"	3' 1/4"	3' 7-1/2"	19-1/2"
LRWB 5-3G6	4,040	6,380	5	16,100	1	160	66	120	6"	4,900	6' 7-3/4"	12' 2-7/8"	3' 1/4"	3' 7-1/2"	19-1/2"
LRWB 5-3H6	4,080	6,420	7.5	18,400	1	160	66	120	6"	4,940	6' 7-3/4"	12' 2-7/8"	3' 1/4"	3' 7-1/2"	19-1/2"
LRWB 5-3I6	4,110	6,450	10	20,200	1	160	66	120	6"	4,970	6' 7-3/4"	12' 2-7/8"	3' 1/4"	3' 7-1/2"	19-1/2"
LRWB 5-4G6	4,580	7,080	5	15,700	1	160	85	120	6"	5,600	7' 3-1/4"	12' 2-7/8"	3' 1/4"	4' 3"	27"
LRWB 5-4H6	4,620	7,130	7.5	18,000	1	160	85	120	6"	5,650	7' 3-1/4"	12' 2-7/8"	3' 1/4"	4' 3"	27"
LRWB 5-4I6	4,650	7,160	10	19,800	1	160	85	120	6"	5,680	7' 3-1/4"	12' 2-7/8"	3' 1/4"	4' 3"	27"
LRWB 5-5G6	5,160	7,860	5	15,400	1	160	105	120	6"	6,380	7' 10-3/4"	12' 2-7/8"	3' 1/4"	4' 10-1/2"	34-1/2"
LRWB 5-5H6	5,210	7,900	7.5	17,700	1	160	105	120	6"	6,420	7' 10-3/4"	12' 2-7/8"	3' 1/4"	4' 10-1/2"	34-1/2"
LRWB 5-5I6	5,240	7,930	10	19,400	1	160	105	120	6"	6,450	7' 10-3/4"	12' 2-7/8"	3' 1/4"	4' 10-1/2"	34-1/2"

† Model Number will end in "-Z" for units with Series Flow piping configuration. Series Flow units may require additional coil connections and will require crossover piping. Model numbers will include "I" for units with Intake Attenuation, "D" for units with Discharge Attenuation, "F" for units with Full Sound Attenuation, "T" for units with a Tapered Discharge Hood, and "S" for units with an option that negates CTI Certification.
 ** Gallons shown is water in suspension in unit and piping. Allow for additional water in bottom of remote sump to cover pump suction and strainer during operation (12" would normally be sufficient).
 Δ When a remote sump arrangement is selected, the spray pump, suction strainer and associated piping are omitted; the unit is provided with an oversized outlet to facilitate drainage to the remote sump.
 ▲ Unit dimensions and coil connections may vary slightly from catalog. See factory certified prints for dimensions, quantity of coil connections, and piping configuration. Coil connections are 4" bevel for weld (BFW), also available as options. Other connection types such as grooved for mechanical coupling or flanged are also available as options.

LRWB 5-3H9 to 5-7K9

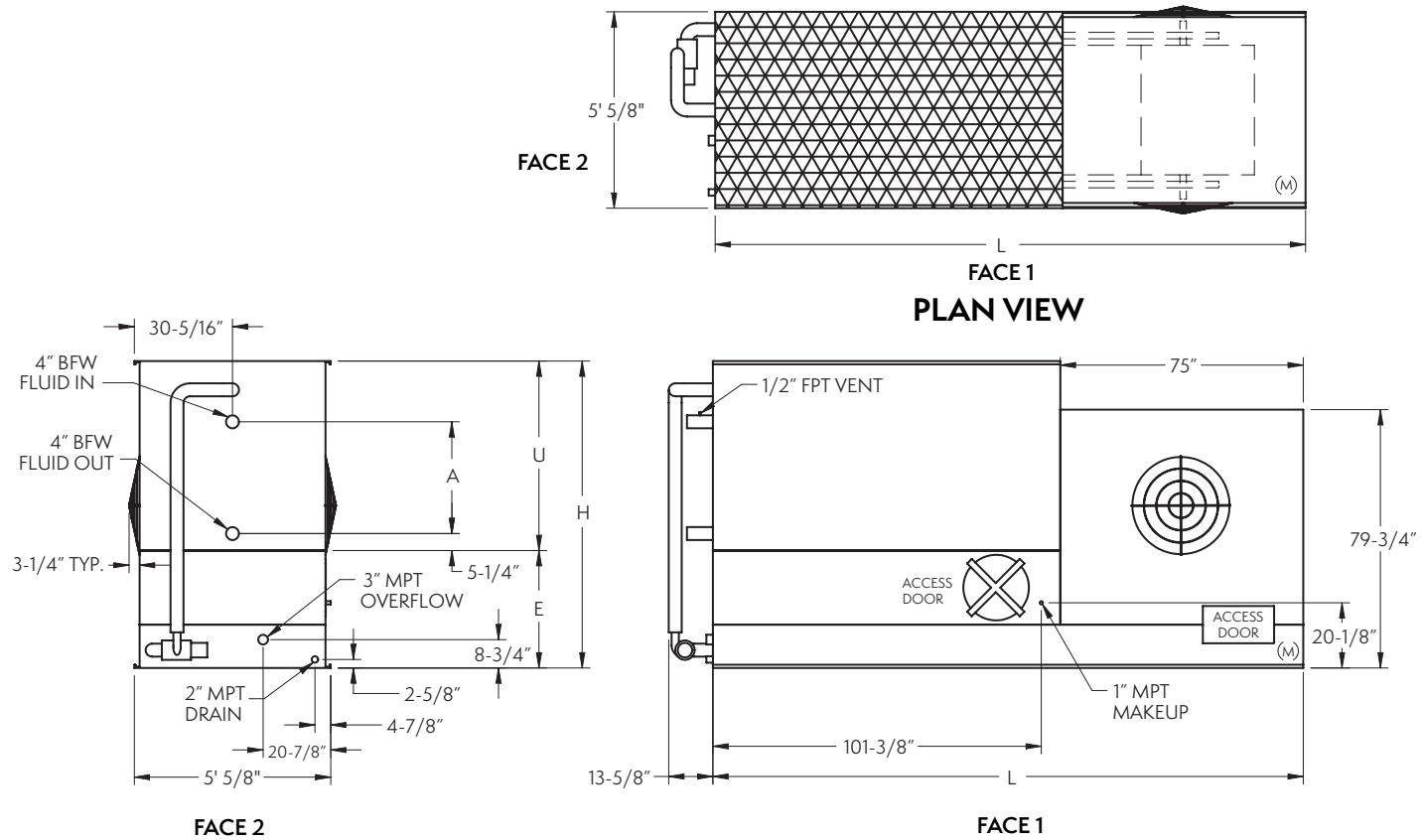

NOTE: The number of coil connections doubles when the flow rate exceeds 450 gpm on 5x9 models. This required option is referred to as the High Flow coil configuration.

Model No. †	WEIGHTS (LBS)		FANS		SPRAY PUMP		Coil Volume (Gallons)	REMOTE SUMP Δ			DIMENSIONS ▲				
	Shipping	Operating	HP	CFM	HP	GPM		Gallons Req'd**	Conn. Size	Operating Weight (lbs)	Height H	Length L	Lower E	Upper U	Coil A
LRWB 5-3H9	5,250	8,730	7.5	22,500	1.5	255	96	170	6"	6,570	6' 7-3/4"	15' 2-1/4"	3' 1/4"	3' 7-1/2"	19-1/2"
LRWB 5-3I9	5,290	8,760	10	24,700	1.5	255	96	170	6"	6,600	6' 7-3/4"	15' 2-1/4"	3' 1/4"	3' 7-1/2"	19-1/2"
LRWB 5-3J9	5,400	8,870	15	28,300	1.5	255	96	170	6"	6,710	6' 7-3/4"	15' 2-1/4"	3' 1/4"	3' 7-1/2"	19-1/2"
LRWB 5-3K9	5,410	8,880	20	31,100	1.5	255	96	170	6"	6,720	6' 7-3/4"	15' 2-1/4"	3' 1/4"	3' 7-1/2"	19-1/2"
LRWB 5-4I9	6,110	9,850	10	24,200	1.5	255	126	170	6"	7,690	7' 3-1/4"	15' 2-1/4"	3' 1/4"	4' 3"	27"
LRWB 5-4J9	6,220	9,960	15	27,700	1.5	255	126	170	6"	7,800	7' 3-1/4"	15' 2-1/4"	3' 1/4"	4' 3"	27"
LRWB 5-4K9	6,240	9,970	20	30,500	1.5	255	126	170	6"	7,810	7' 3-1/4"	15' 2-1/4"	3' 1/4"	4' 3"	27"
LRWB 5-5I9	6,980	10,990	10	23,800	1.5	255	155	170	6"	8,830	7' 10-3/4"	15' 2-1/4"	3' 1/4"	4' 10-1/2"	34-1/2"
LRWB 5-5J9	7,090	11,100	15	27,200	1.5	255	155	170	6"	8,940	7' 10-3/4"	15' 2-1/4"	3' 1/4"	4' 10-1/2"	34-1/2"
LRWB 5-5K9	7,100	11,110	20	29,900	1.5	255	155	170	6"	8,950	7' 10-3/4"	15' 2-1/4"	3' 1/4"	4' 10-1/2"	34-1/2"
LRWB 5-6I9	7,730	12,020	10	23,300	1.5	255	185	170	6"	9,860	8' 6-1/4"	15' 2-1/4"	3' 1/4"	5' 6"	42"
LRWB 5-6J9	7,840	12,130	15	26,600	1.5	255	185	170	6"	9,970	8' 6-1/4"	15' 2-1/4"	3' 1/4"	5' 6"	42"
LRWB 5-6K9	7,850	12,140	20	29,300	1.5	255	185	170	6"	9,980	8' 6-1/4"	15' 2-1/4"	3' 1/4"	5' 6"	42"
LRWB 5-7I9	8,650	13,220	10	22,800	1.5	255	214	170	6"	11,060	9'	15' 2-1/4"	3' 1/4"	5' 11-3/4"	47-3/4"
LRWB 5-7J9	8,760	13,330	15	26,100	1.5	255	214	170	6"	11,170	9'	15' 2-1/4"	3' 1/4"	5' 11-3/4"	47-3/4"
LRWB 5-7K9	8,770	13,340	20	28,700	1.5	255	214	170	6"	11,180	9'	15' 2-1/4"	3' 1/4"	5' 11-3/4"	47-3/4"

† Model Number will end in "-Z" for units with Series Flow piping configuration. Series Flow units may require additional coil connections and will require crossover piping. Model numbers will include "I" for units with Intake Attenuation, "D" for units with Discharge Attenuation, "F" for units with Full Sound Attenuation, "T" for units with a Tapered Discharge Hood, and "S" for units with an option that negates CTI Certification.

** Gallons shown is water in suspension in unit and piping. Allow for additional water in bottom of remote sump to cover pump suction and strainer during operation (12" would normally be sufficient).

Δ When a remote sump arrangement is selected, the spray pump, suction strainer and associated piping are omitted; the unit is provided with an oversized outlet to facilitate drainage to the remote sump.

▲ Unit dimensions and coil connections may vary slightly from catalog. See factory certified prints for dimensions, quantity of coil connections, and piping configuration.

Coil connections are 4" bevel for weld (BFW), also available as options. Other connection types such as grooved for mechanical coupling or flanged are also available as options.

LRWB 5-3J12 to 5-7N12

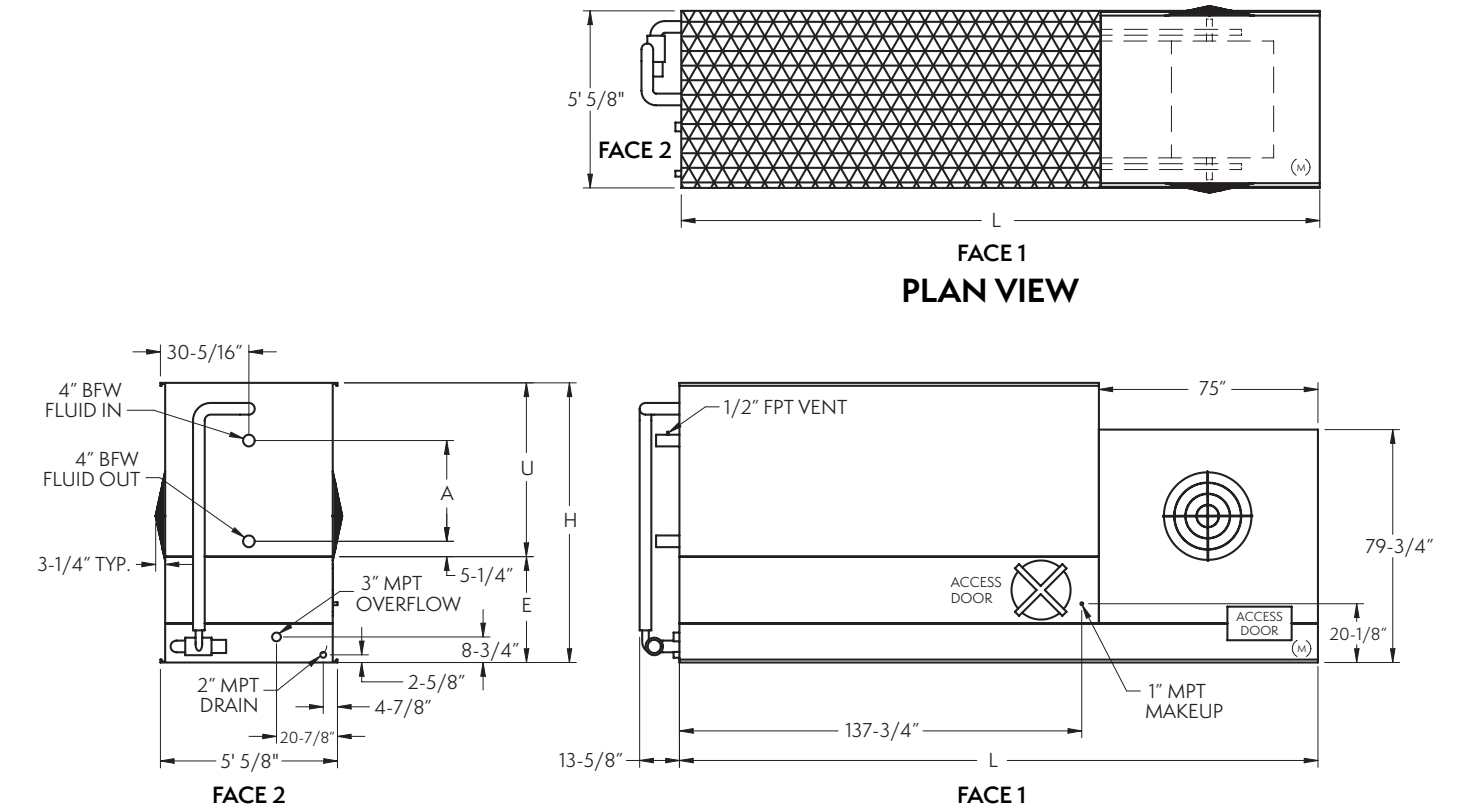

NOTE: The number of coil connections doubles when the flow rate exceeds 450 gpm on 5x12 models. This required option is referred to as the High Flow coil configuration.

Model No. †	WEIGHTS (LBS)		FANS		SPRAY PUMP		Coil Volume (Gallons)	REMOTE SUMP Δ			DIMENSIONS ▲				
	Shipping	Operating	HP	CFM	HP	GPM		Gallons Req'd**	Conn. Size	Operating Weight (lbs)	Height H	Length L	Lower E	Upper U	Coil A
LRWB 5-3J12	6,510	11,220	15	31,700	2	345	127	240	8"	8,360	6' 8-3/4"	18' 2-5/8"	3' 1/4"	3' 8-1/2"	19-1/2"
LRWB 5-3K12	6,530	11,230	20	34,900	2	345	127	240	8"	8,380	6' 8-3/4"	18' 2-5/8"	3' 1/4"	3' 8-1/2"	19-1/2"
LRWB 5-3L12	6,540	11,240	25	37,600	2	345	127	240	8"	8,390	6' 8-3/4"	18' 2-5/8"	3' 1/4"	3' 8-1/2"	19-1/2"
LRWB 5-3M12	6,560	11,270	30	39,900	2	345	127	240	8"	8,410	6' 8-3/4"	18' 2-5/8"	3' 1/4"	3' 8-1/2"	19-1/2"
LRWB 5-4J12	7,630	12,700	15	31,100	2	345	166	240	8"	9,850	7' 4-1/4"	18' 2-5/8"	3' 1/4"	4' 4"	27"
LRWB 5-4K12	7,640	12,720	20	34,200	2	345	166	240	8"	9,860	7' 4-1/4"	18' 2-5/8"	3' 1/4"	4' 4"	27"
LRWB 5-4L12	7,650	12,730	25	36,900	2	345	166	240	8"	9,870	7' 4-1/4"	18' 2-5/8"	3' 1/4"	4' 4"	27"
LRWB 5-4M12	7,670	12,750	30	39,200	2	345	166	240	8"	9,890	7' 4-1/4"	18' 2-5/8"	3' 1/4"	4' 4"	27"
LRWB 5-5K12	8,720	14,170	20	33,500	2	345	206	240	8"	11,310	7' 11-3/4"	18' 2-5/8"	3' 1/4"	4' 11-1/2"	34-1/2"
LRWB 5-5L12	8,740	14,180	25	36,100	2	345	206	240	8"	11,320	7' 11-3/4"	18' 2-5/8"	3' 1/4"	4' 11-1/2"	34-1/2"
LRWB 5-5M12	8,760	14,200	30	38,400	2	345	206	240	8"	11,350	7' 11-3/4"	18' 2-5/8"	3' 1/4"	4' 11-1/2"	34-1/2"
LRWB 5-5N12	9,090	14,530	40	42,200	2	345	206	240	8"	11,680	7' 11-3/4"	18' 2-5/8"	3' 1/4"	4' 11-1/2"	34-1/2"
LRWB 5-6L12	9,750	15,570	25	35,400	2	345	245	240	8"	12,710	8' 7-1/4"	18' 2-5/8"	3' 1/4"	5' 7"	42"
LRWB 5-6M12	9,770	15,590	30	37,600	2	345	245	240	8"	12,730	8' 7-1/4"	18' 2-5/8"	3' 1/4"	5' 7"	42"
LRWB 5-6N12	10,110	15,920	40	41,400	2	345	245	240	8"	13,060	8' 7-1/4"	18' 2-5/8"	3' 1/4"	5' 7"	42"
LRWB 5-7L12	10,950	17,140	25	34,600	2	345	285	240	8"	14,280	9' 1"	18' 2-5/8"	3' 1/4"	6' 3/4"	47-3/4"
LRWB 5-7M12	10,970	17,160	30	36,800	2	345	285	240	8"	14,300	9' 1"	18' 2-5/8"	3' 1/4"	6' 3/4"	47-3/4"
LRWB 5-7N12	11,300	17,490	40	40,500	2	345	285	240	8"	14,630	9' 1"	18' 2-5/8"	3' 1/4"	6' 3/4"	47-3/4"

† Model Number will end in "-Z" for units with Series Flow piping configuration. Series Flow units may require additional coil connections and will require crossover piping. Model numbers will include "I" for units with Intake Attenuation, "D" for units with Discharge Attenuation, "F" for units with Full Sound Attenuation, "T" for units with a Tapered Discharge Hood, and "S" for units with an option that negates CTI Certification.

** Gallons shown is water in suspension in unit and piping. Allow for additional water in bottom of remote sump to cover pump suction and strainer during operation (12" would normally be sufficient).

Δ When a remote sump arrangement is selected, the spray pump, suction strainer and associated piping are omitted; the unit is provided with an oversized outlet to facilitate drainage to the remote sump.

▲ Unit dimensions and coil connections may vary slightly from catalog. See factory certified prints for dimensions, quantity of coil connections, and piping configuration.

Coil connections are 4" bevel for weld (BFW), also available as options. Other connection types such as grooved for mechanical coupling or flanged are also available as options.



- World Headquarters
Research & Development Center
- EVAPCO Manufacturing Facilities

EVAPCO, Inc. — World Headquarters & Research / Development Center

P.O. Box 1300 • Westminister, MD 21158 USA
410.756.2600 • marketing@evapco.com • evapco.com

North America

- EVAPCO, Inc.**
World Headquarters
Westminister, MD USA
410.756.2600
marketing@evapco.com
- EVAPCO East**
Taneytown, MD USA
- EVAPCO East**
Key Building
Taneytown, MD USA
- EVAPCO Midwest**
Greenup, IL USA
217.923.3431
evapcomw@evapcomw.com
- Evapcold Manufacturing**
Greenup, IL USA
- EVAPCO West**
Madera, CA USA
559.673.2207
contact@evapcowest.com
- EVAPCO Alcoil, Inc.**
York, PA USA
717.347.7500
info@evapco-alcoil.com
- EVAPCO Iowa**
Lake View, IA USA
- EVAPCO Iowa**
Sales & Engineering
Medford, MN USA
507.446.8005
evapcomn@evapcomn.com

- EVAPCO LMP ULC**
Laval, Quebec, Canada
450.629.9864
info@evapcolmp.ca
- EVAPCO Select Technologies, Inc.**
Belmont, MI USA
844.785.9506
emarketing@evapcoselect.com
- Refrigeration Vessels & Systems Corporation**
Bryan, TX USA
979.778.0095
rvs@rvscorp.com
- Tower Components, Inc.**
Rameur, NC USA
336.824.2102
mail@towercomponentsinc.com
- EvapTech, Inc.**
Edwardsville, KS USA
913.322.5165
marketing@evaptech.com
- EVAPCO Dry Cooling, Inc.**
Bridgewater, NJ USA
908.379.2665
info@evapcodc.com
- EVAPCO Dry Cooling, Inc.**
Littleton, CO USA
908.895.3236
info@evapcodc.com
- EVAPCO Power México S. de R.L. de C.V.**
Mexico City, Mexico
(52) 55.8421.9260
info@evapcodc.com

Asia Pacific

- EVAPCO Asia Pacific Headquarters**
Baoshan Industrial Zone Shanghai, P.R. China
(86) 21.6687.7786
marketing@evapcochina.com
- EVAPCO (Shanghai) Refrigeration Equipment Co., Ltd.**
Baoshan Industrial Zone, Shanghai, P.R. China
- EVAPCO (Beijing) Refrigeration Equipment Co., Ltd.**
Huairou District, Beijing, P.R. China
(86) 10.6166.7238
marketing@evapcochina.com
- EVAPCO Air Cooling Systems (Jiaxing) Company, Ltd.**
Jiaxing, Zhejiang, P.R. China
(86) 573.8311.9379
info@evapcochina.com
- EVAPCO Australia (Pty.) Ltd.**
Riverstone, NSW, Australia
(61) 02.9627.3322
sales@evapco.com.au
- EvapTech (Shanghai) Cooling Tower Co., Ltd**
Baoshan District, Shanghai, P.R. China.
Tel: (86) 21.6478.0265
- EvapTech Asia Pacific Sdn. Bhd.**
Puchong, Selangor, Malaysia
(60) 3.8070.7255
marketing-ap@evaptech.com

Europe | Middle East | Africa

- EVAPCO Europe EMENA Headquarters**
Tongeren, Belgium
(32) 12.39.50.29
evapco.europe@evapco.be
- EVAPCO Europe BV**
Tongeren, Belgium
- EVAPCO Europe, S.r.l.**
Milan, Italy
(39) 02.939.9041
evapcoeuropa@evapco.it
- EVAPCO Europe, S.r.l.**
Sondrio, Italy
- EVAPCO Europe A/S**
Aabybro, Denmark
(45) 9824.4999
info@evapco.dk
- EVAPCO Europe GmbH**
Meerbusch, Germany
(49) 2159.69560
info@evapco.de
- EVAPCO Middle East DMCC**
Dubai, United Arab Emirates
(971) 56.991.6584
info@evapco.ae
- Evap Egypt Engineering Industries Co.**
A licensed manufacturer of EVAPCO, Inc.
Nasr City, Cairo, Egypt
(20) 10.05.432198
evapco@tiba-group.com
- EVAPCO S.A. (Pty.) Ltd.**
A licensed manufacturer of EVAPCO, Inc.
Isando, South Africa
(27) 11.392.6630
evapco@evapco.co.za

South America

- EVAPCO Brasil**
Equipamentos Industriais Ltda.
Indaiatuba, São Paulo, Brazil
(55) 11.5681.2000
vendas@evapco.com.br
- FanTR Technology Resources**
Itu, São Paulo, Brazil
(55) 11.4025.1670
fantr@fantr.com